



UNIVERSITÀ  
degli STUDI  
di CATANIA

Precast lightness  
cardboard architecture responds to emergency  
design, prototyping and testing of a high performance emergency house-kit

doctoral dissertation

Dario Luigi Distefano

June 2019



UNIVERSITÀ  
degli STUDI  
di CATANIA

DICAR University of Catania  
Ph.D. in architectural engineering, sustainable design  
Cycle XXXI  
Evaluation and mitigation of urban and land risks

Precast lightness  
cardboard architecture responds to emergency  
design, prototyping and testing  
of a high performance emergency house-kit

doctoral dissertation

Dario Luigi Distefano

June 2019

supervisor

Professor Antonio Gagliano

advisors

Professor Vincenzo Sapienza

Professor Rossella Caponetto

*dedico questo lavoro ai miei soci-amici-fratelli  
con i quali ho condiviso quello che è stato  
e con i quali condividerò quello che sarà*

# Index

<b>1/ introduction</b>	<b>3</b>
1.1 ForewordCiao	4
1.2 Problem overview	10
1.3 Motivation	12
1.4 Aim and object of the research	15
1.5 Methodology and tools	17
<b>2/ background</b>	<b>21</b>
2.1 The timelessness of the tent	22
2.2 The avant-gardes of '900	22
2.3 Contemporary production	44
2.4 Three Italian cases	49
2.5 Emergency house-kit	51
<b>3/ design criteria</b>	<b>59</b>
3.1 The meaning of habitability	60
3.2 Civil Protection technical guideline	63
3.3 Comparative analysis	74
3.4 Emergency design strategies	77
3.5 Bioclimatic design strategies	91
3.6 Design indexes	96
<b>4/ cardboard architecture</b>	<b>101</b>
4.1 The roots of the research	102
4.2 Corrugated cardboard	103
4.3 Archicart technology	109
4.4 Heat flow meters measurements	113
<b>5/ cardboard house-kit</b>	<b>121</b>
5.1 Design process	122
5.2 Tools	122
5.3 Modular design	147
5.4 Architectural design	164
5.5 Technical proposal	168
5.6 Parametric design	174
5.7 Executive design	196
<b>6/ T-Box</b>	<b>203</b>
6.1 The meaning of prototyping	204
6.2 The prototype purposes	207
6.3 Tools	210
6.4 Prototyping of a cardboard house-kit	222
6.5 Testing	246
<b>7/ results</b>	<b>251</b>
7.1 What is expected	252
7.2 Level of self-construction	252
7.3 Environmental performances	254
<b>conclusion</b>	<b>265</b>

# 1/ introduction

This first chapter deals with the concept of temporariness related to architecture. The speculative foreword brings to the understanding that adjective “temporary” does not mean poor but reversible. Emergency architecture is a form of temporary architecture addressed to displaced people and actually is characterized at least by three housing types: tent, container and prefabricated housing module.

## 1.1 Foreword

The contemporary inhabiting is the results of the evolution of the concepts of space and time, which switches the absolute paradigm from a space-centred into a time-centred one.

In the past, the space of solid objects, including architecture, was immortal, absolutely independent from the invisible flowing of time. According to Bauman the relation between space and time in solid modernity was unbalanced and characterized by the pregnant supremacy of space, that is able to win the challenge of immortality against time<sup>1</sup>.

According to Bauman the relation between space and time in solid modernity was unbalanced and characterized by the pregnant supremacy of space, that is able to win the challenge of immortality against time..

The mankind of solid modernity tends to materialize in built objects what is invisible and ethereal (like power or money), to save it from the equally invisible and therefore uncontrollable flowing of time. This concept faithfully represents the conceiving of past architecture products, made to resist over time and firmly connected to the place where they were built. Terpolilli<sup>2</sup> says that this was the condition that permitted to give an identity to places. Now these concepts only represent answers to the idea of identity, but they do not represent answers to transformation process and contemporary changes.

This change starts when speed enters into social dynamics as plus-value, increasing space and becoming new quality index. Technology turns its attention to speed increase, to acceleration of operations, to dynamism of events and to changes. Speed is the new life engine and the change is the aim of creativity, intellect and technology.

From mobility to information and communication, from living to travelling, contemporary man pins his attention on accelerated and dynamic system that continuously changes. The Contemporary is fragmented into single instantaneous and ubiquitous moments, that are as powerful and infinite as the entire time horizon.



Figure 1/ Turtle Woman, Eugénie Tazè-Berbard - The artist presents a vision of a chaotic world overcome by modern life, inviting the spectator to contemplate what could happen to the humankind's future. It sparks the idea of human bodies adapting to new shapes that could cover them and become a protection. It represents a way to escape, to stay in silence and connect with oneself. Lucca Biennale, 2018, picture of the author.

*The 'long term', though still referred to by habit, is a hollow shell carrying no meaning; if infinity, like time, is instantaneous, meant to be used on the spot and disposed of immediately, then 'more time' can add little to what the moment has already offered. Not much can be gained from the 'long-term' considerations. If 'solid' modernity posited eternal duration as the main motive and principle of action, 'fluid' modernity has no function for the eternal duration to play. The 'short term' has replaced the 'long term' and made of instantaneity its ultimate ideal. While promoting time to the rank of an infinitely capacious container, fluid modernity dissolves - denigrates and devalues - its duration.*

Zygmunt Bauman<sup>3</sup>

Inhabiting is fragmented, atomized in time and in space. Places and living moments become transitional states, in which space-time horizons are no longer static, but dynamic<sup>4</sup>.

The architectural project of contemporaneity is equally dynamic and opposes an impermanent performative experience to the certainty of perennial duration. This concept is coherent with the new human awareness of the temporary entity of one's own condition of life.

The more the project and the built space are able to refer to the dimension of the time, the more the architecture will bring the values of its own adherence to the real needs and its appropriate possible transformation<sup>5</sup>.

### **Temporary is not synonymous of low durability or low quality**

Temporary architecture matches a kind of use limited in time, determinate on an unbound lapse with materials durability and based on users' needs.

Roberto Bologna explains that temporary architecture is an architecture programmed for the satisfaction of contingent needs and for a determinate time destination. The project, as transition programme, moves the attention from the temporariness of the fruition and/or localization to the temporary nature of the built object as material fact. Giving to the product the "transition feature" from a previous state to the next one, means operating in terms of reversibility of building process. It is hard to conceive that the inversion of building process can allow retracing backwards the sequences of operation to return to the starting point. This is due to dissipative nature of building process in which it is hard to conceive energy restoration in a sort of circular model. Actually it is better represented by a spiral model of an indefinite endurance of components and materials

*from form to form and from location to location*

Figure 2 / ◀ Shigeru Ban's Paper Dome was built the first time in Kobe, Nagata, Japan after the earthquake in 1995. It was conceived for lasting 10 years and after 20 years was deconstructed and given to the community of Puli, Nantou, Taiwan - © Malcolm Koo - via commons.wikimedia.org



as Touw says in her dissertation, investigating the concept of permanence in its forms: static versus dynamic<sup>6</sup>. The first one is easy to understand: a building is fixed in its location and it needs continual maintenance and retrofit works to make it useful and safe for users. The second one is coherent with the other dimension of permanence that accepts the need for repairing, but it is not bound to a single location or function.

However, dynamic permanence does not mean ephemeral. The difference, Touw explains, is that dynamic permanence accepts single components enduring path, as sort of cycle of reuse or transformation; ephemeral architecture, as Distefano says in 2014 quoting Unali<sup>7</sup>, is a sort of indefinite performance experience that opposes to eternal durability a temporary modification of space, which is reversible and has no end-of-life product. With ephemeral architecture, the ambition of an endless duration is definitely abandoned to make space to the most coherent principle of the appropriate duration.

Therefore, a product of architecture is temporary, not because it does not last long, but because it lasts until it is useful, until it likes, until it is used<sup>8</sup>. When people do not need it, do not like it, or do not use it, it must be removable, without leaving any permanent sign in the environment, neither visible nor invisible.

Durability is a derivation of human usage

*The durability of the human artifice is not absolute; the use we make of it, even though we do not consume it, uses it up. The life process which permeates our whole being invades it, too, and if we do not use the things of the world, they also will eventually decay, return into the over-all natural process from which they were drawn and against which they were erected. If left to itself or discarded from the human world, the chair will again become wood, and the wood will decay and return to the soil from which the tree sprang before it was cut off to become the material upon which to work and with which to build. But though this may be the unavoidable*

*end of all single things in the world, the sign of their being products of a mortal maker, it is not so certainly the eventual fate of the human artifice itself, where all single things can be constantly replaced with the change of generations which come and inhabit the man-made world and go away. Moreover, while usage is bound to use up these objects, this end is not their destiny in the same way as destruction is the inherent end of all things for consumption. What usage wears out is durability.*

Hannah Arendt. “the human condition”

Arendt offers 3 points of view to define durability

- It is relative, because it is a variable of human needs and usage
- Human artifice returns in nature if it is not useful
- The sign of all single things of the products of a mortal maker remains in the environment

In these sentences there is the presupposition for understanding the meaning of permanence and temporary for architecture’s products.

Spending energy to maintain building in efficiency is as low sustainable as building, without think to final destination of building components and materials. This architecture process is permanence ambition with no care about signs that building can leave in the environment.

To make the building’s components and materials returnable in nature they must be reversible. All production and maintenance process must not change this condition.

### **Temporary is synonymous with reversible**

Architecture can be a temporary modification of territory, of environment and of land. The contemporary project must not ignore the solutions for the end of the life of architectural products and for the restoration of territory, environment and land. The strategy of incorporating into the project the transience of the manufactured, means thinking of a



non-destructive action, whose output is not waste, but goods, that keep the potential of use as intact as possible for a re-entry into a further production cycle, or reintegration into the natural environment<sup>9</sup>.

The project of temporary architecture contains the solution to release components, materials and goods that are temporary employed in the building and derived from its disassembly process. The end of life of temporary architecture products is not demolition but disassembly, re-use for components, and re-cycle for materials.

The reversibility of construction process, as Bologna says, can be represented as a disintegration process in 3 levels:

1. Technological disintegration, system components may be disconnected and dis-assembled
2. Physical disintegration, components returns in their base materials with environmental and state changes,
3. Biological disintegration, system components and materials are biodegradable.

## 1.2 Problem overview

*Il valore della pianificazione diminuisce con la complessità dello stato delle cose*

Ottaviano Augusto<sup>10</sup>

Housing emergency is one of the central problems to which all communities must give rapid and reliable answers.

Recent scene is characterized by an increasing of social pressure due to changes that have troubled human condition, from fights to economic crisis, from environment changes to growing of poverty.

The consequence of this social pressure is the uncontrolled resources consumption and transformation of territories, without referring to their

intrinsic vulnerability. The growing of anthropic pressure and the consequent concentration of population in high-risk places, has led the explosion of effects of natural disaster, such as floods, earthquake, tsunami, in terms of lost life, evacuees and refugees.

In risk analysis, this means increasing of assets, that are people, property, information and all the other items we aim to protect.

$$\text{Asset} + \text{Threat} + \text{Vulnerability} = \text{Risk}$$

In the past, we used to think at emergency states (instability) as singularity of normality states (stability) that were well distinguishable because of their duration: long period of normality instead of short period of emergency<sup>11</sup>.

Now this condition is changed. Often, emergency states are longer than normality ones and we are accustomed that emergency is our normality.

*The perpetuation of emergency phenomena and natural disasters must lead the community to review the concept of extraordinary nature of this phenomenon: the continuity of natural disasters, often caused by questionable territorial management, lead us to consider the phenomenon of emergency from exception to rule.*

Corrado Seller<sup>12</sup>

This point of view derives from technological and economical development, that enhances our awareness of change and its consequences.

The awareness of not-singular emergency condition for communities and of vulnerability of the territories generates a rethinking of the planning praxis: we need a culture of project that is able to understand territorial nature, elaborate scenarios and put in place resources and solutions. The need of this kind of project is current throughout the trigger event.

The importance of this culture turns the attention from the approach of planning in emergency to the actual emergency planning. The first one has characterized the praxis until the last 30 years and has manifested how

planning after a trigger event slows down the rescue machine in the operations of researching resources, assigning roles and tasks, coordinating volunteers or localizing safe areas.

The approach of emergency planning represents a turning point in the field of civil protection. The territory is mapped in relation to risk levels and, this way, it is clear who, how, when and with what resources can take action in case of emergency.

The Italian Department of Civil Protection was established with the laws N.225/1992 and D. Lgs. N.112/1998. These two rules assign functions and roles to all the institutions involved in risk relevance.

In Italy, emergency planning is based on “metodo Augustus”: a guideline for the flexible emergency planning, conceived according to the risks of the territory. This guideline clearly delineates a simple working method in identifying and activating procedures to effectively coordinate the civil protection response. This method replaces the previous approach of census of useful means, and introduces the new concept of resource availability<sup>13</sup>.

### 1.3 Motivation

*[...] once and for all we must stop to call it fatality. We always talk about fatality, but the fatality does not exist [...] we talk about how guilty, good or bad nature is, but nature is neither good nor bad. It is indifferent to our suffering, but nonetheless, it has given us a great quality that is intelligence, and indeed we have always defended ourselves, we have always got dressed, we have built banks against the rivers, we have built houses, the houses, [...] when you look for a man you always find a home.*

Renzo Piano, 2016, Che Tempo che Fa

In the first half of 2018, is estimated<sup>14</sup> that there were about 8,5 mil-

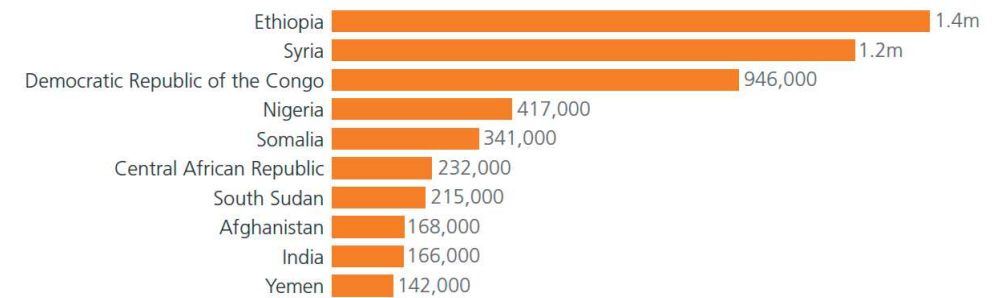

Figure 3 / Countries with most new displacements associated with conflict and violence from January to June 2018 - [www.internal-displacement.org](http://www.internal-displacement.org)

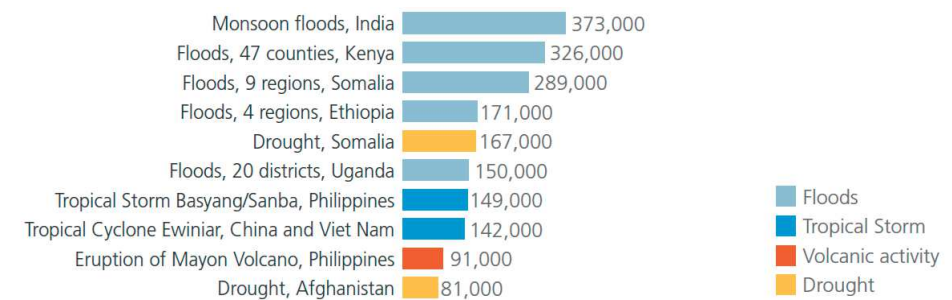

Figure 4 / Ten largest disaster displacement events from January to June 2018 - [www.internal-displacement.org](http://www.internal-displacement.org)

lion new internal displacements: 5,2 million associated with conflicts and violence in ten of the worst-affected countries, and 3,3 million associated with disasters in 110 countries.

In 2017 the number of new displacements was of 30,5 million.

Housing emergency is a common issue of contemporary architecture: due to this number of displacements, the request of inhabiting solutions becomes normality for the project of architecture, that must figure out the urgency of the request.

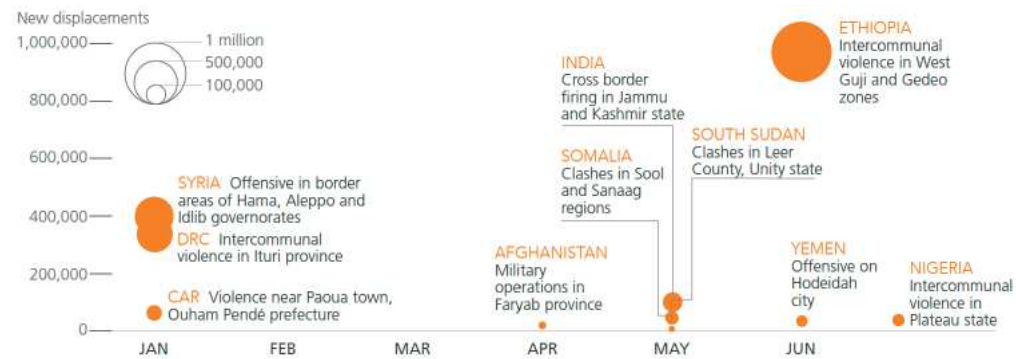

Figure 5 / Main conflict events from January to June 2018 - [www.internal-displacement.org](http://www.internal-displacement.org)

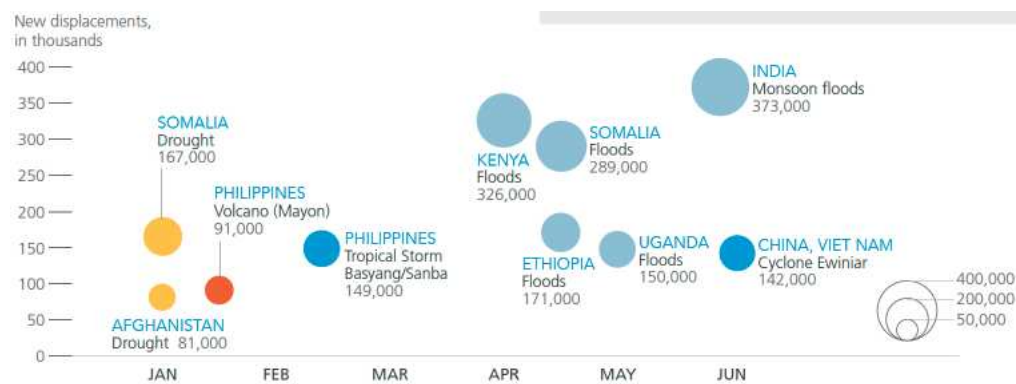

Figure 6 / Main disaster events from January to June 2018 - [www.internal-displacement.org](http://www.internal-displacement.org)

Natural disasters, materials and information mobility, migrations, temporary shelters for refugees and asylum-seekers, overlap in the chaotic daily life of the built-in city, that is not able to carry out strategies and solutions through the standard tools of the traditional project of architecture.

Cities are the daily shelters of passengers in transit from a survival state to another one. The role of architecture project is to endow transitional housing with formal, functional and technological quality, calibrated on actual needs, environmental conditions and resources availability.

Nowadays, emergency housing solutions are still the result of the market of industrial production. For lack of project guidelines, the companies, which work in the field of building prefabrication, offer solutions for emergency in the range of products of their manufacturing. The hard work of the people in charge of crisis management is to choose the best solution in the modest market of available products.

The emergency project is the new cultural challenge of contemporary architecture for rethinking its methods to find solutions of intervention in accord with official planning of crisis managers. These solutions must be simple, secure and suitable, also available at zero time. This approach could be the best practice against the actual one, which searches for project solutions after crisis event and not in prevision of it. The “after emergency project” does not care about involved subjects and is not sustainable in a time of crisis..

Corrado Seller claims the necessity of specialized sectors of academic courses focused on the theme of emergency, to form experts able to project emergency on the base of predictive schemes, techniques and models of efficient and suitable intervention.

## 1.4 Aim and object of the research

Talking about time referring to emergency is often talking about “less time”. After the zero time, “less time” is always the best time. If a trigger event causes a housing need, there are suddenly provided tents and other rapid shelters to protect victims. After damage evaluation, it is counted how many displaced people there are and how many housing modules they need. Every day, between the need evaluation and the building of housing modules, for the victims is a new day in a tent.

The scope of this research is to provide a comfortable housing module that could be assembled by victims themselves in more time than putting up a tent, but in less time than setting up a standard emergency inhabiting solution.

The project of a temporary emergency housing module is the result of an interdisciplinary approach that engages form and function studies, materials and technologies, territory and climate, to match the traditional design issues (such as comfort, safety and quality), with the particular issues of an emergency application, among which transportability, quickness, facility and repeatability.

The aim of the research is to define the properties of a prefabricated dwelling system, that make it useful as emergency shelter. This collection of properties is the starting point of the proposal of a high performance affordable housing module, made up of cardboard and destined to emergency. The research will demonstrate the technology feasibility during the self-construction phase, and the high level of environmental comfort during the operational phase of this proposed high-performance-housing-module.

**Technology feasibility**

Proving the feasibility means unravelling all nodes of technological conformation that characterize the system. The development of the research passes through the realization of an operative full-scale prototype. To reach this objective, the author has involved 31 students of the Department of Engineering and Architecture and 5 companies to invest their experience and products to produce the full-scale prototype of the emergency housing module.

**Environmental comfort**

Inhabiting a place for a short period of time is not the same of inhabiting a place for a long one. Our perception of comfort is not the same. The object of this research is to verify, in Mediterranean climate, the environmental performance of a temporary housing module, made up of cardboard structural panels and destined to emergency use.

Figure 7 / ► Conceptual map of the methodology and tools

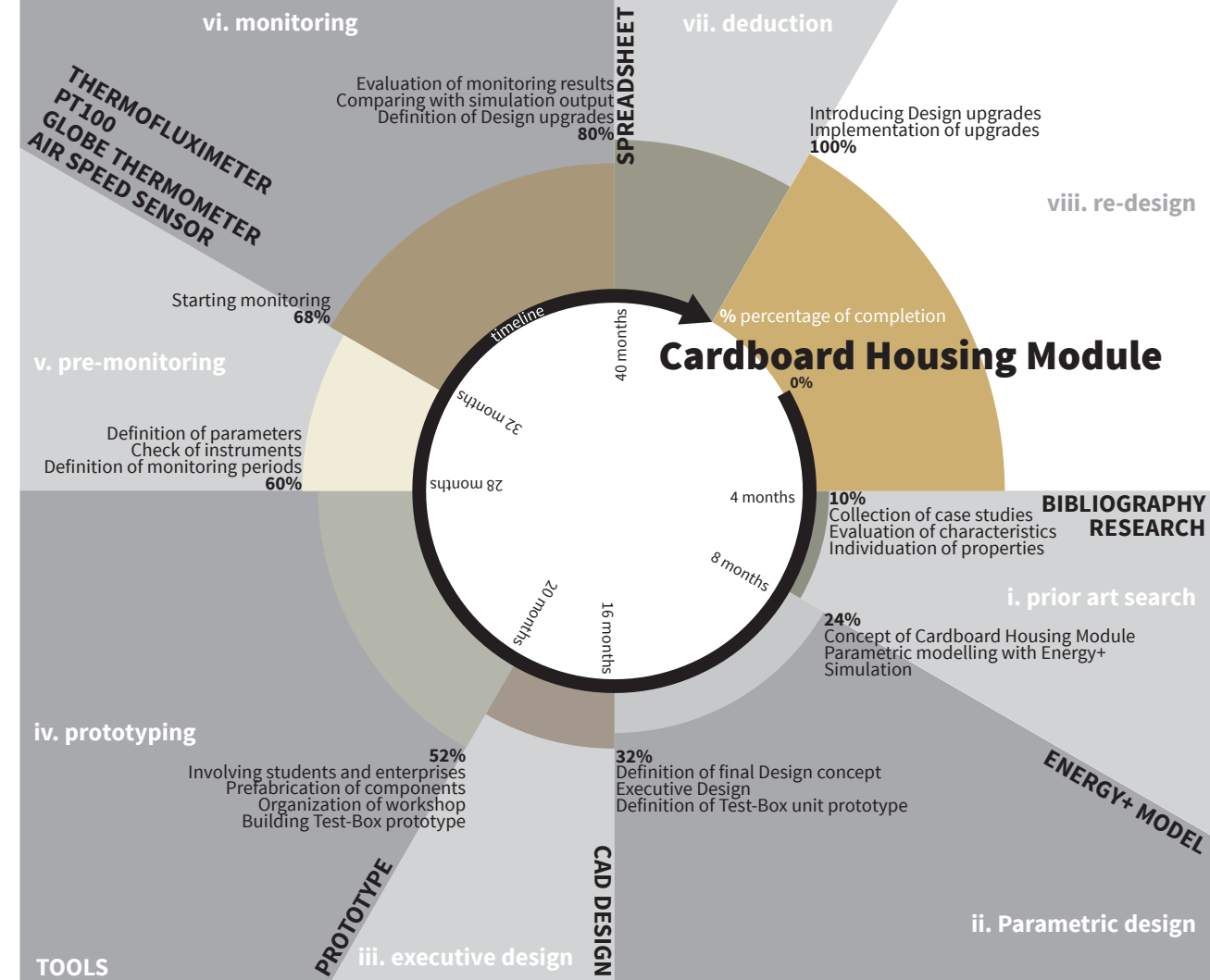

1.5 Methodology and tools

The methodological approach of the research is based on a circular model. The research starts with the collection of case studies and the design of the concept, and ends with a new phase of design of concept, which calls into question the first concept, on the base of new issues deriving from prototyping and monitoring. What follows is the list of the steps of this research, that will be explained in detail in the next chapters of this work:

- i. Prior art search

A great background of case studies has been consulted to extrapolate

the constitutive properties of housing modules. The array of collected properties is the first design tool to formulate a concept of prefabricated housing module.

ii. Parametric design

Parametric design is the great way to match form and function design with climate passive strategies. The formulation of parametric libraries of materials and behaviour schedules makes the project adaptable to climate, and this adaptability has been validated by simulations.

iii. Executive design

After the proof of the concept, obtained by simulations, it follows the phase of finalization of technology system, by making a project of details, through: the selection of market products, the definition of component size and tolerances and the elimination of thermal bridges.

iv. Prototyping

The realization of a real-scale prototype to reach the level of technology readiness of validity in relevant environment. The prototype has been called “Test-Box” (it represents a significant part of the complete housing module), and it has been conceived to validate construction feasibility and actual environmental performances.

v. Pre-monitoring

Understand the environmental context of Test-Box prototype to set up instruments and sensors and choose relevant performances to be monitored.

vi. Monitoring

Setup of instruments and start monitoring in different climate periods.

vii. Deduction

The elaboration of the datasheets of monitoring results is the last phase of the research, it is helpful to create a new scheme of actual characteristics and expected performances.

viii. Re-design

The next step of the research is the re-design of the model in accord with the scheme of new project inputs.

#### Footnotes chapter 1

- 1 Distefano D. L. (2014), p. 18
- 2 Terpolilli C. (2005)
- 3 Bauman Z. (2002), p.125
- 4 Bologna R. (2005)
- 5 Terpolilli C. (2005)
- 6 Touw K. (2006), p.13
- 7 Distefano D. L. (2014), p. 23
- 8 Ban S. (2012), TED\*Tokyo
- 9 Bologna R. (2005)
- 10 ANVVFC - Delegazione Augustus
- 11 Terpolilli C. (2005)
- 12 Seller C. (2005), p. 316
- 13 ANVVFC - Delegazione Augustus
- 14 Internal Displacement Monitoring Centre (IDMC) (2018)

## 2/ background

Starting from nomads' tent, Chapter 2 retraces the experimentations of the second half of twentieth century until the present day. The collection of case studies is useful for listing the recurrent criteria of the emergency design.

## 2.1 The timelessness of the tent

The first form of temporary architecture is certainly the tent.

Nomads of the past and modern day nomads often have to leave the place where they live because of climate conditions, economy, availability of food, family needs, wars or disasters.

In the past, the tents had protected the humankind from generations to generations. They fitted in forms, colours, materials and techniques with every territory and culture.

The most of nomads' tents stayed standing until the family was alive and then it ended its lifecycle. Nomads did not conceive inhabiting as something permanent and the dwelling as possession. The home is a temporary exploitation of natural resources<sup>1</sup>.

The minimal house in flexible form for flexible use is the last landing of the tent, of the hut or of the caravan. The scientific progress has to reach the identity of the shelter archetype, through a research focused on a simple, flexible and innovative house: a dismantled and removable house that remains on a place like a new version of the previous hut, without compromising the equilibriums<sup>2</sup>.

The architecture has the role of fixing quality and stability to the moving form of a house, that has made the dynamism and adaptability the emblem of its conceptual strength.

## 2.2 The avant-gardes of '900

The problem of temporary prefabricated housing modules is often bound to industrial series production due to its intrinsic property of repeatability and availability. The industrial design dominated the scene of housing prefabrication until the first half of '900.

The first sign of real architect-led experimentation was the *Dymaxion House 4D*, the project of the visionary Richard Buckminster Fuller, who thought that the soul of prefabrication was the transfer of industrial pro-

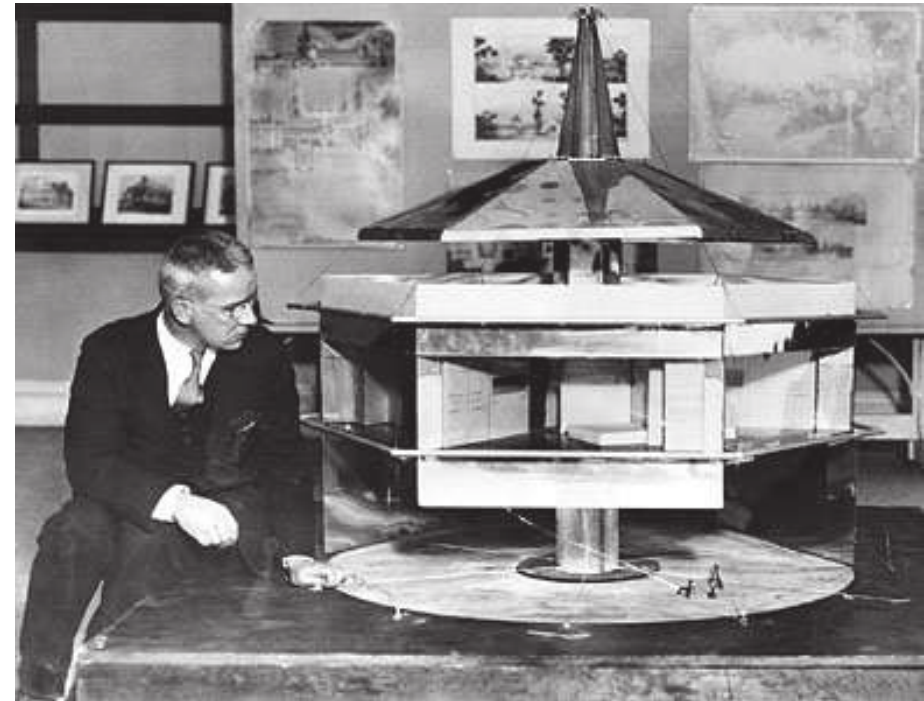

Figure 8 / Buckminster Fuller with his Dymaxion Dwelling Machine, 1930 - © Bettmann/Corbis - via www.britannica.com

duction.

Dymaxion means Dynamic Maximum and Tension and represents the aim of the project: a self-sustaining dwelling made up of prefabricated components easily shipped in a package. Even though it was not built, Dymaxion house represents an innovation that has influenced the following productions.

The *Hexagonal house* was an earthquake-proof and weather resistant 100 m<sup>2</sup> structure, supported by a cable mesh that was held up by a stainless steel centre. This system allowed the outer walls to be non-bearing. Fuller matched the objective of a flexible plan, modifiable by users, by grouping all permanent utilities in the central pole. Here Fuller planned and patented<sup>3</sup> an independent self-sustaining minimum bathroom, which was a monobloc plastic spot of 1,5 m<sup>2</sup>. Fuller paid attention also to energy

efficiency of the dwelling by adding wind turbines on the roof and water tanks to collect rainwater<sup>4</sup>.

After 14 years Fuller succeeded in building a new version of Dymaxion House called *Dymaxion Deployment Unit* (DDU) for US Army.

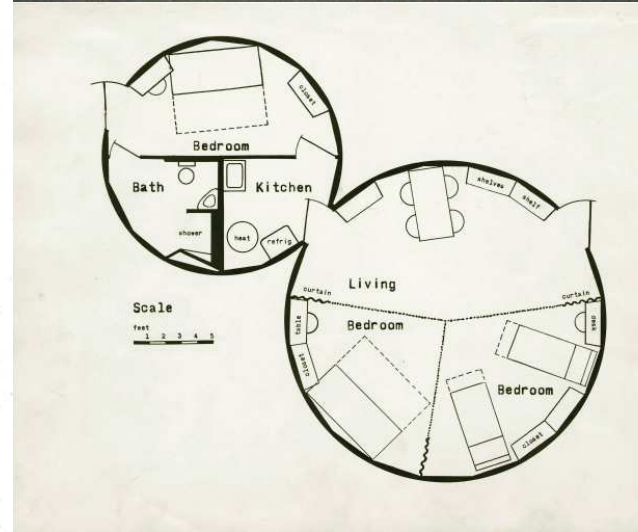

Figure 11 / ▲◀ Installation of a Dymaxion Deployment Unit at The Museum of Modern Art New York, 1941 - [www.moma.org](http://www.moma.org)  
 Figure 12 / ▲► B. Fuller during the installation of a Dymaxion Deployment Unit at The Museum of Modern Art New York, 1941 - [www.moma.org](http://www.moma.org)  
 Figure 13 / ▼◀ Plan of a Dymaxion Deployment Unit, 1941 - [www.moma.org](http://www.moma.org)  
 Figure 14 / ▲► Installation of a Dymaxion Deployment Unit at The Museum of Modern Art New York, 1941 - [www.moma.org](http://www.moma.org)

In DDU<sup>5</sup> Fuller solved assembly, transportation and providing issues emerged in the Dymaxion house. The DDU was built with the corrugated metal sheets of Butler Manufacturing Company's silos. The choice of a circular plan was not casual. The cylindrical form optimizes material consumption and realizes a good thermal regulation based on aerodynamic techniques. The roof is a conical dome made up of the same metal sheet,

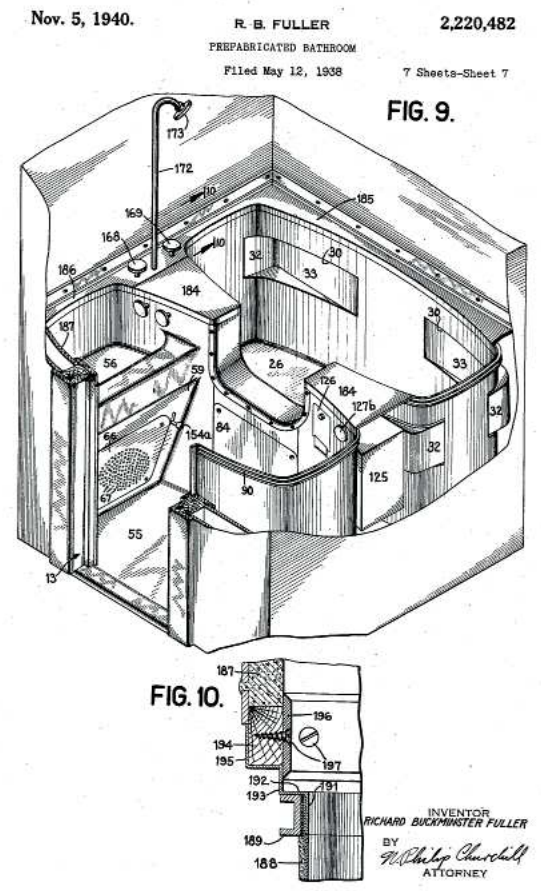
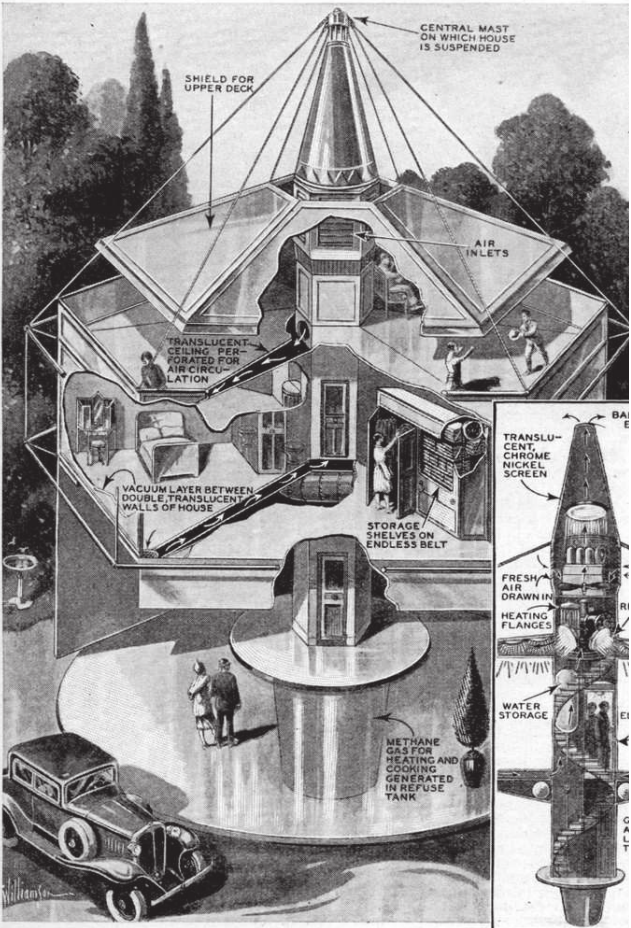

Figure 9 / ◀ Fuller's drawing of Dymaxion House - [www.archdaily.com](http://www.archdaily.com)  
 Figure 10 / ► Buckminster Fuller's patent of prefabricated plastic bathroom - patent No. US.2.220.482



curved to follow the form of the building. In the central part there is a hole through which the steel pole, that is useful to maintain in tension the envelope, passes. There is no other framework as load-bearing component.

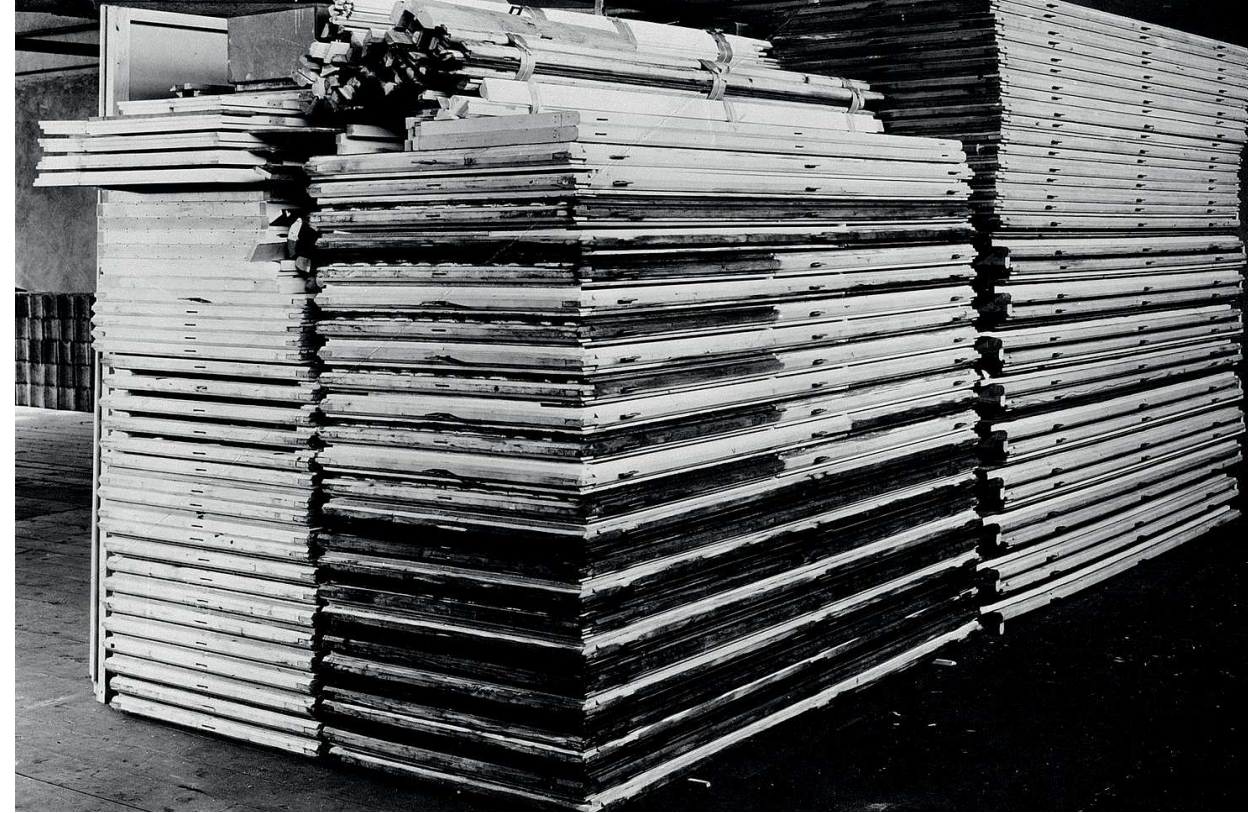
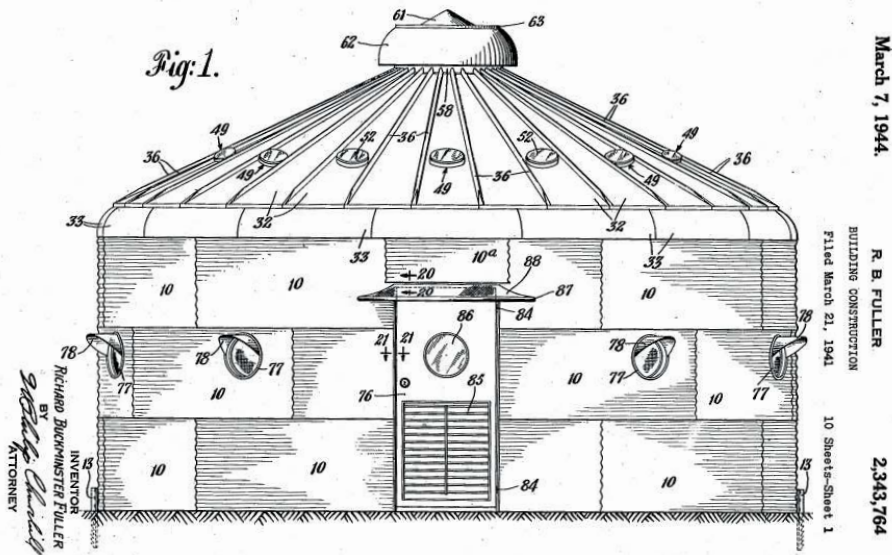
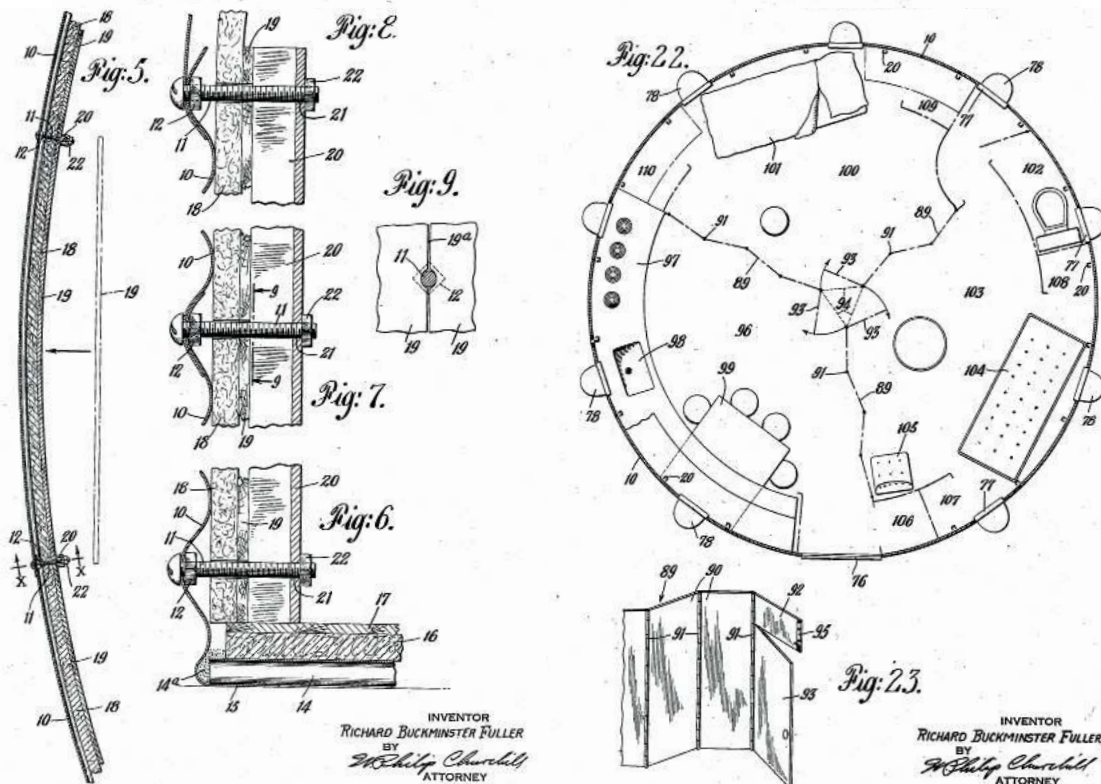

Figure 15 / ◀ Drawings of Fuller's patent: particular of front elevation and plan; detail of metal sheet connections, 1944 - Patent No. US.2.343.764  
 Figure 16 / ▲ The Packaged House System - © VG Bild-Kunst, Bonn 2017, photo George H. Davis - via www.moderne-regional.de



In 1942, Konrad L. Wachsmann and Walter Gropius designed and patented the *Packaged House System* for the General Panel Corporation<sup>6</sup>. Is interesting to report the aims of the work of Wachsmann and Gropius described in the introduction of their patent.

*The invention aims to transfer most of the labour involved in the construction of a building from the site of the building itself to a factory and to make the erection of the building primarily one of assembly. Is a further object of the invention to devise a construction which will eliminate practically all the necessity for using nails, screws, hooks, and similar fastenings during such assembly, but to provide a more satisfactory means for securing the sections together and to make the sections so standardized that with only minor exceptions, any frame section can be interchanged with any other.*



Aug. 8, 1944. K. L. WACHSMANN ET AL. 2,355,192  
 PREFABRICATED BUILDING  
 Filed May 30, 1942 7 Sheets-Sheet 1

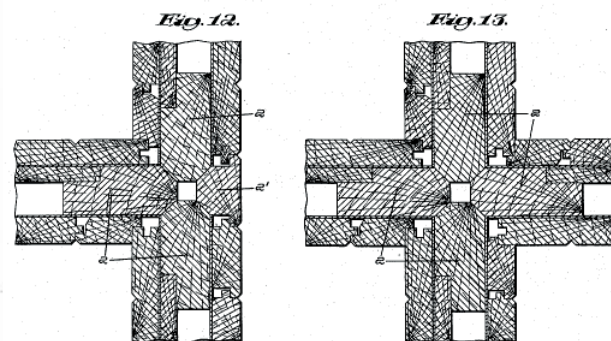
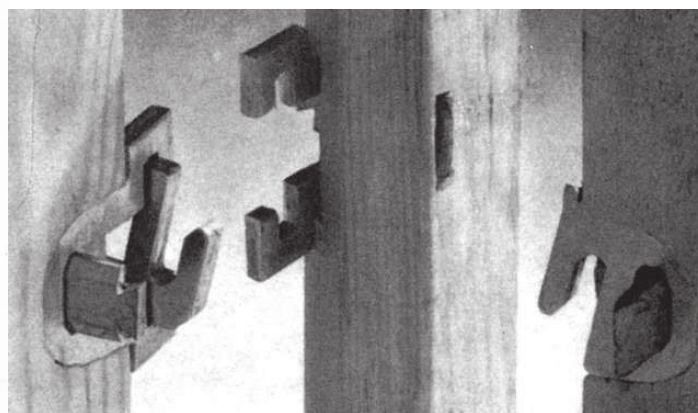
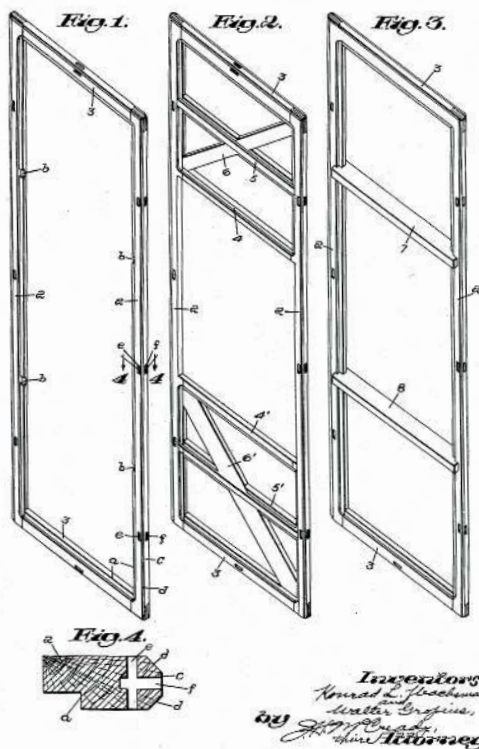

The inventors fixed two principles of prefabricated design: the transfer of the most part of site operations to a factory equipped with machinery for efficiently and accurately producing; the modularity of components is conceived to reduce assembly time and to reduce the use of fastenings.

The house system is planned as a rectangular single level floor, with a pitched roof and an inset porch. The entire structure is panelled, and the panels are identical in proportion, edge profile and method of connection. The modular system allow not to build single repetitive units, but infinite configurations, adaptable to various climatic and site conditions, and users' needs.

The employment of 4-element-steel connectors allows to easily assemble the structural members on site. All the components, such as panels, columns, roof, have got the same extreme end holes to be joined together with these steel connectors. The structure becomes rigid and load-bearing only when the 4 structural components are arranged into place and connected together. Laboratory tests has verified that panels collapse before the connections.

As Alicia Imperiale says, the "Packaged House" is a closed system because of its proprietary building materials, only designed for the system and made up of non-standard module size. The panels for example are 101,6 cm (3'-4") wide × 304,8 cm (10') high (vertical height could be determined in 101,6 cm increments, 3 of which make the 304,8 cm module), so they does not correspond to the industry standard of 121,9 cm × 243,8 cm (4'×8") plywood panels and to the other modular elements. Thus, windows, doors, and the other architectural fittings would be modular only to the system.

Figure 17 / ◀▲ William F. Karsten, Konrad L. Wachsmann, Walter Gropius on the construction site of a Packaged House, 1942-1952 - [www.harvardartmuseums.org](http://www.harvardartmuseums.org)

Figure 18 / ◀▼ Detail of Packaged House System - © Sparks Co Inc NY / Wachsmann Wendepunkt im Bauen, Krausskopf, 1959 - Stephane Berthier via [www.researchgate.net](http://www.researchgate.net)

Figure 19 / ◀▼ Drawings of Packaged House patent: particular of panels type and details of joints, 1942 - Patent No. US.2.343.764

A minimum house for the colonies was patented in 1937 by the constructor Pietro Ferrero on the design of Giuseppe Pagano. The patented system proposes a logical, economic and easy-to-implement solution, suitable for the houses of colonies, for rural areas, for artisans and workers.

The entirely prefabricated structure, made up of concrete panels, is designed to be assembled on site without further use of mortar and plaster. Each panel is equipped with two wings that make the panels mutually interlocked. A jet of concrete fills internal gaps as reinforcement. The walls are thus perfectly smooth and resistant and do not need any plastering.

The flat roof consists of grooved beams that are supported every 80 cm by the pillars obtained in the double wall. Between these beams waterproof interlocking boards are fixed, they are slightly curved upwards.

The plan solutions start from the minimum of 35 m<sup>2</sup> to the maximum of 95 m<sup>2</sup>, offering different solutions both in terms of space and costs. Each type has two entrances, one on the main street and the second one on the back garden, the latter designed as a small terrace from which you can also access to toilets outside the home. The single-level houses are designed with a floating floor and equipped with standard doors and windows<sup>7</sup>.

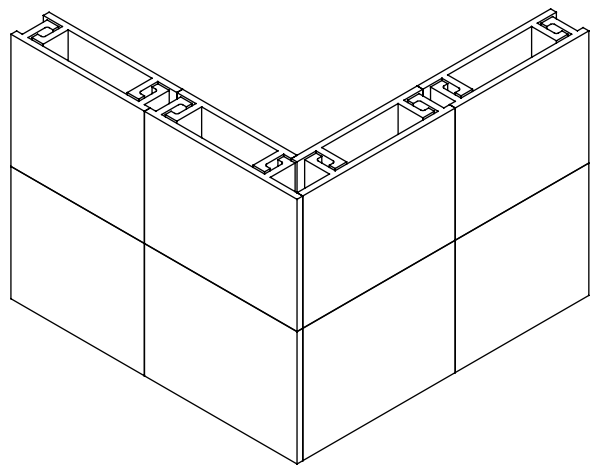

Figure 20/ Ferrero Structural system by Giuseppe Pagano - drawing of the author

Figure 21/ ► “Assembly diagram for a shelter; double shelter” Ateliers Jean Prouvé, 1940 - Jean Prouvé 4×4 Military Shelter, 1939 - vol. 9 pp. 18-19 - © 2016 Edition Galerie Patrick Seguin

Jean Prouvé indirectly came to architecture: the production of technically innovative housing components led him to enter the field of building design and to hone construction methods.

His principles were implemented in response to France’s post-war reconstruction drive and the need for affordable, mass-produced housing<sup>8</sup>.

Jean Prouvé began using the wood in 1939 in temporary barrack buildings commissioned by the French Army. The program was to create within a period of one month, 275 movable modules approximately of 4 m × 4 m. The scarcity of steel during that period led to the idea of using metal only for the structure and creating the envelope using modular, solid timber panels, that incorporated doors and windows. These panels were prefabricated and then assembled on site<sup>9</sup>.

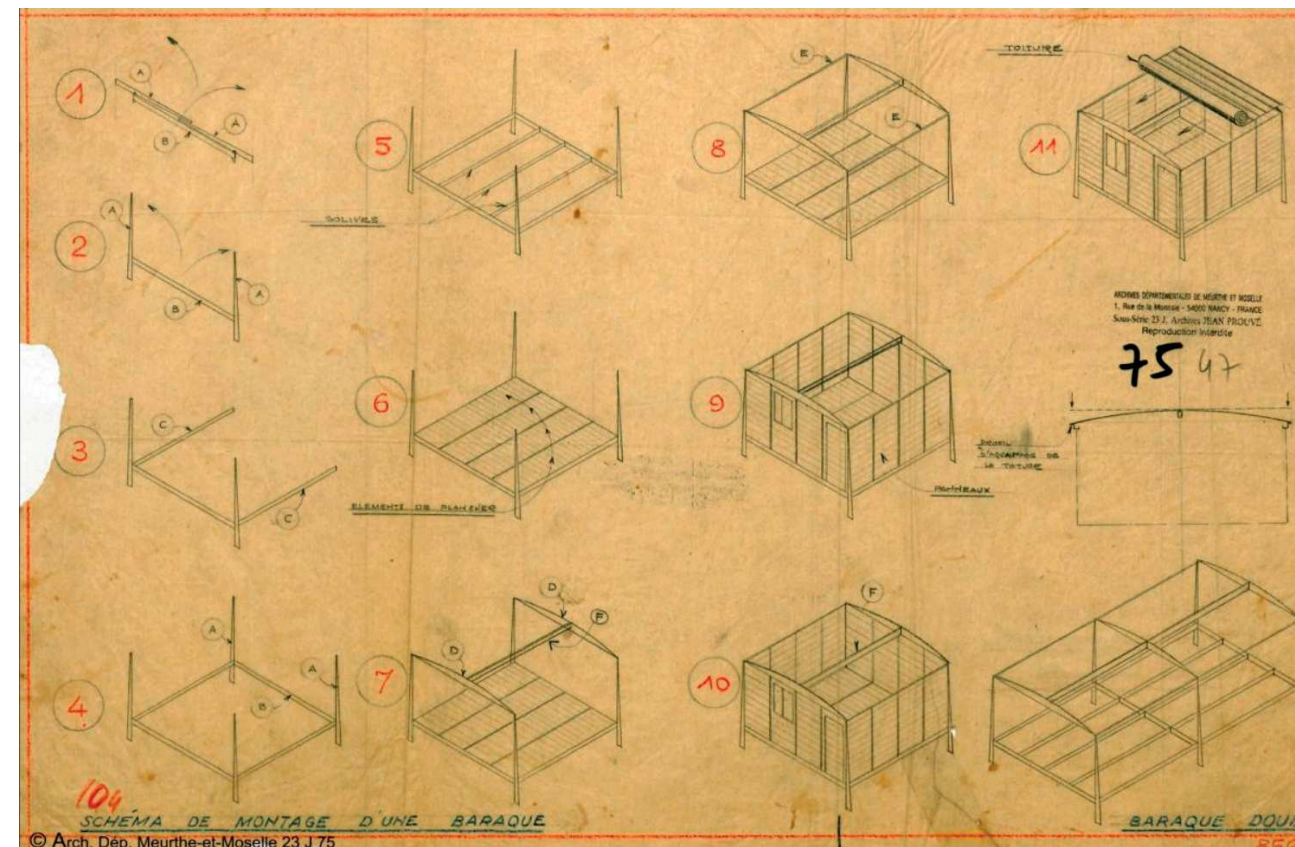

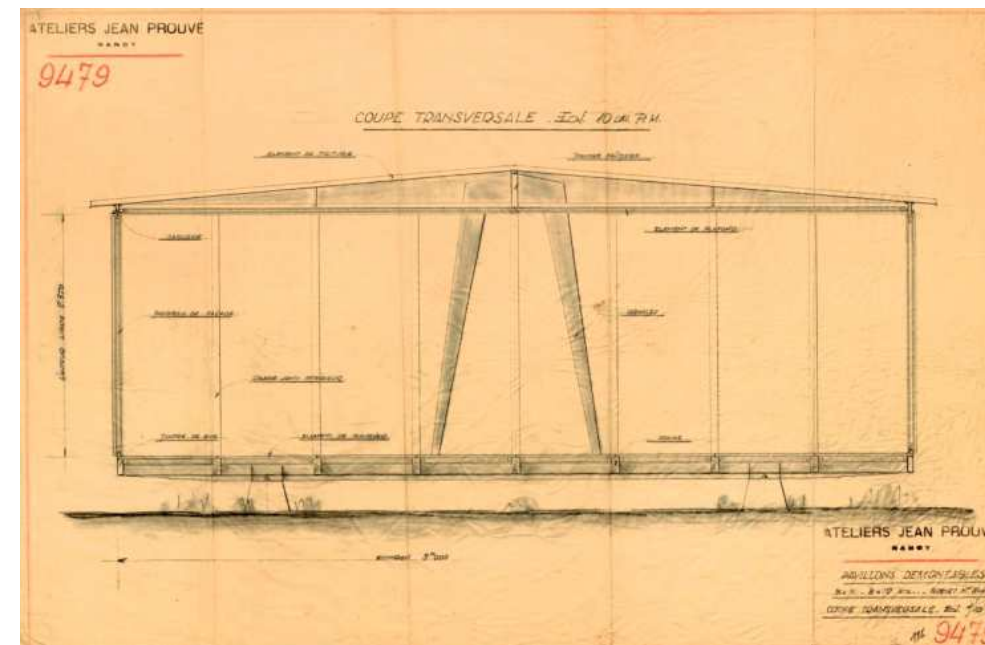

Figure 22 / ▲ “Demountable houses 8×8, 8×12, etc. cross section” Ateliers Jean Prouvé, 1944 Patent No. 849.762 - Jean Prouvé 8×8 Demountable House, 1944 - vol. 2 pp. 24-25 - © 2014 Edition Galerie Patrick Seguin

Figure 23 / ◀▲ Jean Prouvé 4×4 Military Shelter, Ferembal, Nancy, France 1939 - © Galerie Patrick Seguin - via [www.phillips.com](http://www.phillips.com)

Figure 24 / ◀▼ Jean Prouvé 8×8 Demountable House - © Galerie Patrick Seguin, 2019 - via [www.patrickseguin.com](http://www.patrickseguin.com)



The assignment of reconstruction combined with his research of the potentialities of the axial portal frame system started in 1938 with the patent of the Jean Prouvé’s Ateliers of the 8 m<sup>2</sup> *Demountable metal-frame structure*. The size was based on the capacity of the big bending press in his workshop, which machined 4 m sheets of steel. The minimum area was of 64 m<sup>2</sup> per module: a living space acceptable both for the occupants and constructors with their interests at heart.

In 1944–45, after meticulous transposition of Prouvé’s construction methods to family housing, 8×8 Demountable Houses were produced, with improvements aimed for greater comfort. The load-bearing structure was entirely made of bent sheet steel, as the floor joists and the roof, unusually made of slabs.

In 1944 Jean Prouvé was involved in the recovery of the region both for the fact that he was born in Nancy and that he was a clever builder. He won an invitation to tender for emergency housing from the Ministry of Reconstruction and Town Planning. Not all the houses, built in 1944 to rehouse war victims in Lorraine, survived to the post-war period. Readily transported and dismantled, Prouvé's *shacks*, entirely made of wood and metal (the latter was in very short amount), were a real architectural coup. These components were directly shipped to bomb-devastated villages, and there two persons were sufficient for assembling them on site in a day.

Figure 25 / Jean Prouvé 8x8 Demountable House - © Galerie Patrick Seguin, 2019 - via [www.patrickseguin.com](http://www.patrickseguin.com)



Set in the Symbol Zone's Theme Pavilion at the 1970 Osaka World Exposition, the *Capsule House* was designed to convey the futuristic architectural theme.

The Capsule House was suspended from the space frame in the pavilion, and a window was added in the living room's floor to see the ground below. The installation of the substructure (architecture) into the mega-structure (city infrastructure) shows how cities could be in the future.

The *Nakagin Capsule Tower* is the first world's capsule architecture, built for real use. Capsule architecture design, for the use of the capsule as room and its insertion into a mega-structure, is a true example of free architecture.

Figure 26 / ▲ Expo'70 Theme Pavilion "Capsule House", Kisho Kurokawa, 1970 - © Kisho Kurokawa Architect & Associates - via [www.kisho.co.jp](http://www.kisho.co.jp)

Figure 27 / ▼ Nakagin Capsule Tower, Kisho Kurokawa, 1972 - © Arcspace - via [www.archdaily.com](http://www.archdaily.com)

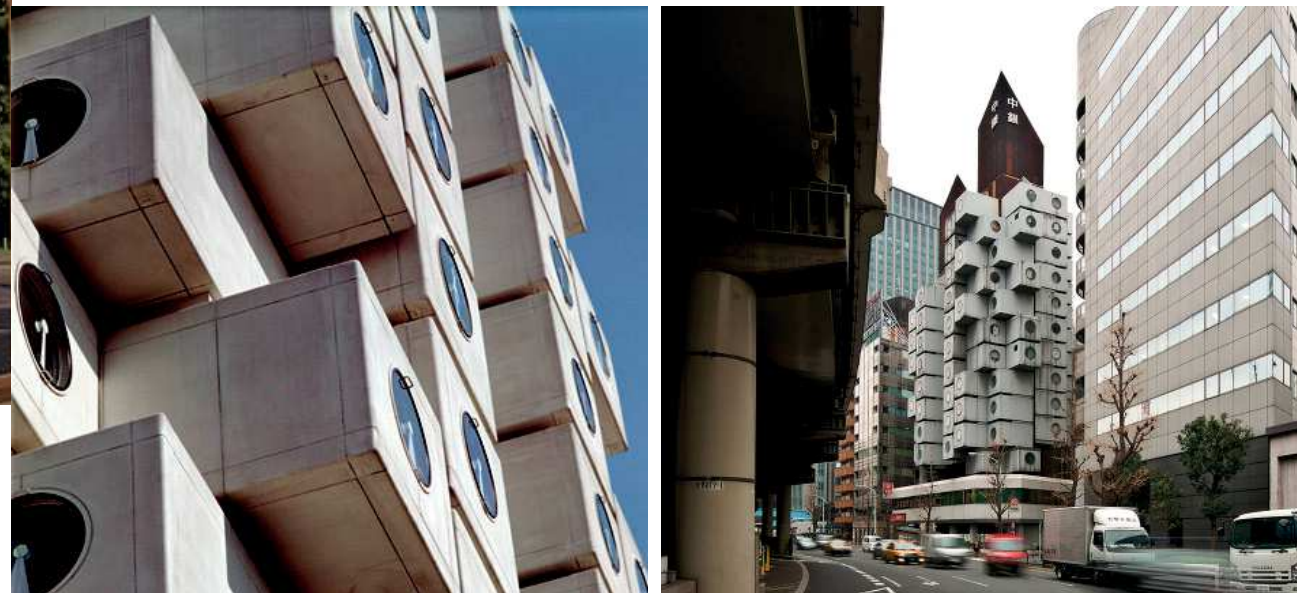



Kisho Kurokawa developed the technology for installing the capsule units into a concrete core through only 4 high-tension bolts, and for making the units detachable and replaceable. The capsule is designed to accommodate an individual as either an apartment or a studio space, and, by connecting units, it can also accommodate a family. Furnished with furniture and appliances, such as audio system and telephone, the capsule interior is pre-assembled in a factory off-site. The interior is then hoisted by cranes and fastened to the concrete core shaft.

Figure 28 / ◀ Nakagin Capsule Tower, Kisho Kurokawa, 1972 - © Noritaka Minami - via archeyes.com

Three emblematic Italian precedents in designing of housing environments were the protagonists of The Museum of Modern Art of New York in 1972, in the exhibition called Italy: the New Domestic Landscape, directed by Emilio Ambasz.

In the category of House Environment, Joe Colombo presented his most revolutionary designs: true living machines, self-contained equip-

Figure 29 / Italy: the new domestic landscape achievements and problems of Italian design - Edited by Emilio Ambasz - © 2017 The Museum of Modern Art



ment, that plug into the wall and re-imagine how objects could fulfil human needs in the new world order<sup>10</sup>.

The *Total Furnishing Unit* (TFU), realized in 1972, was a homogeneous living system that contained all daily life personal necessities, by creating a seamless environment.

This environment is made up of four independent volumes: the first (the central block) contains two beds and a caster table under its raised floor, at the upper level it contains two small rooms, conceived as private places, separated from each other by small built-in closets and an outward-facing bookshelf. The second, third and fourth volumes are a caster wardrobe, a kitchen block and a bathroom block. The volumes can be composed in various shapes and in different ways<sup>11</sup>.

Emilio Ambasz writes about TFU introducing it as follows:

*If we accept the premise that homogeneity is the concept on which our designs are based, then the methodology characterizing them can be divided as follows:*

- a) Relationship between city and dwelling unit*
- b) Relationship between parkland and dwelling unit*
- c) Relationship between man and dwelling unit.*

*The dwelling should be adapted more and more to the man, and never the contrary.*<sup>12</sup>

The unit presented a concept of the modern housing unit thanks to the fact that every space area could be modified and moved, based on users' own necessity, showing a great flexibility.

*It is worth noting that while the kitchen and bathroom serve only their original purposes, the cupboard acts as a screen between entrance and possible night area, or, at any rate, separates two areas, and the night-day unit (bed and privacy) serves all the functions of living, from sleeping, eating, reading, receiving friends, etc. to withdrawing to an internal room especially designed for this purpose.*<sup>13</sup>

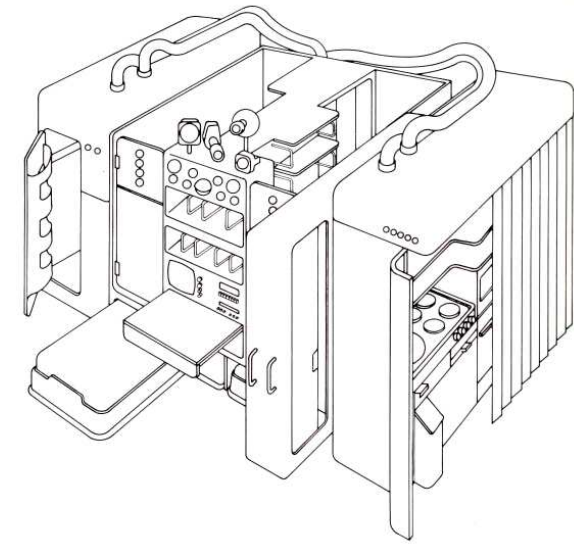
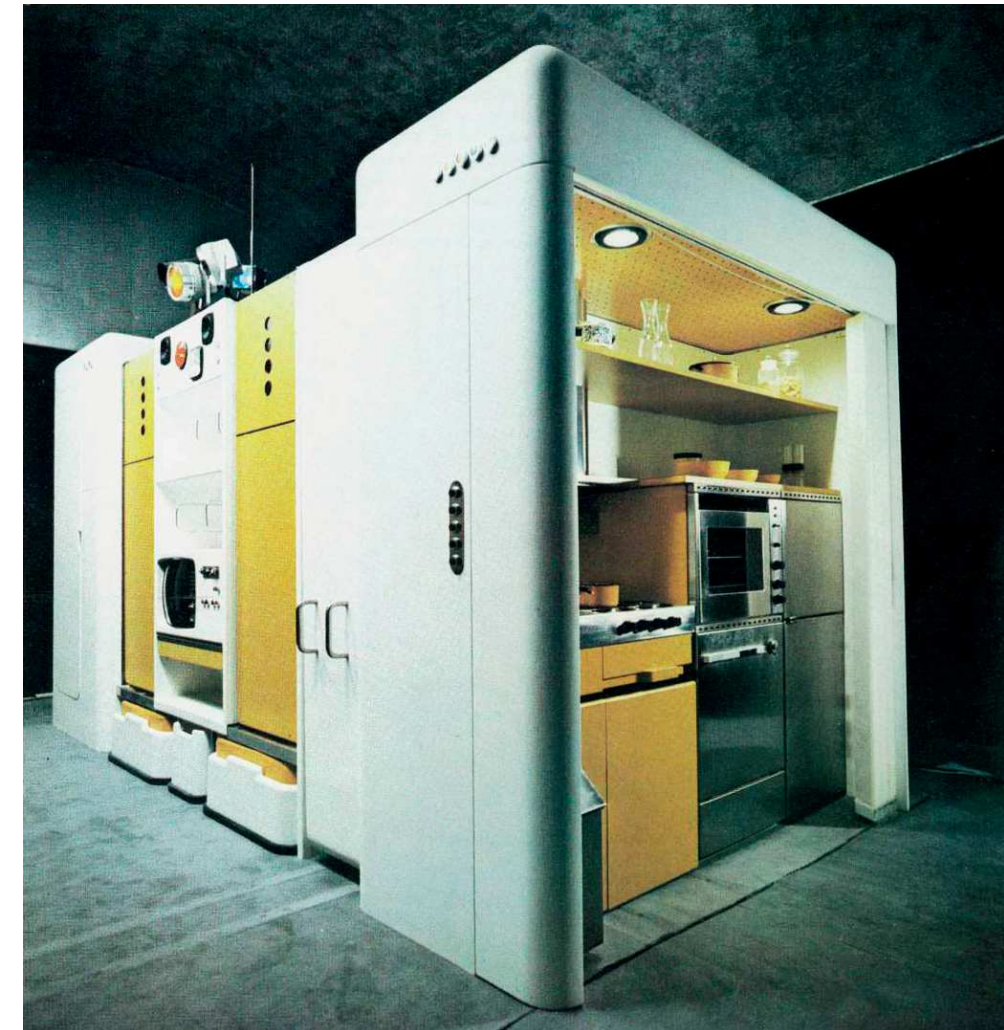

Figure 30 / Total Furnishing Unit, Joe Colombo 1972 - Italy: The new domestic landscape - © 2017 The Museum of Modern Art



Sponsored by Fiat for external chassis structure and by ANIC for internal modules, furnishings and equipment, the housing module of Marco Zanuso and Richard Sapper is a concentrate of innovation, because of their sapient use of industrial existing components.

The two long walls of the container are in part hinged and they could be folded down to form terraces. Two large plastic capsules, one containing the bed, the other the kitchen, slide out from the interior of the capsule onto the terraces during normal use. Two further plastic capsules in the interior contain respectively the toilet and the wardrobe. This solution not only answers to the requirements of a mobile home, but the redesigned container can be also seen as a component element of a housing scheme, since they could be stacked one on top of another, or arranged along the contours of the land.

*The project aims at treating the topic of a mobile environment on another scale than that of a trailer or camper in order to be able to deal with the following problems:*

- 1. emergency housing, which means environments to be used not for weeks but perhaps for a year. This calls for more space and less provisory appliances than provided by a camper type solution;*
- 2. rapid and massive relief action in cases of calamities avoiding the delays connected with the acquisition of territory and obtaining construction permits, unavoidable in all systems of permanent construction;*
- 3. physical and ecological hazards of road traffic by using the possibilities of integrated transport which the container concept offers;*
- 4. the semipermanent second residence.<sup>14</sup>*

The project is based on a housing unit, which is mobile, expandable and aggregated.

Mobility is obtained by designing the unit, in close configuration, with the same size and structural specifications of standard freight containers.

Expandability is obtained by dividing the unit's structure into two cate-

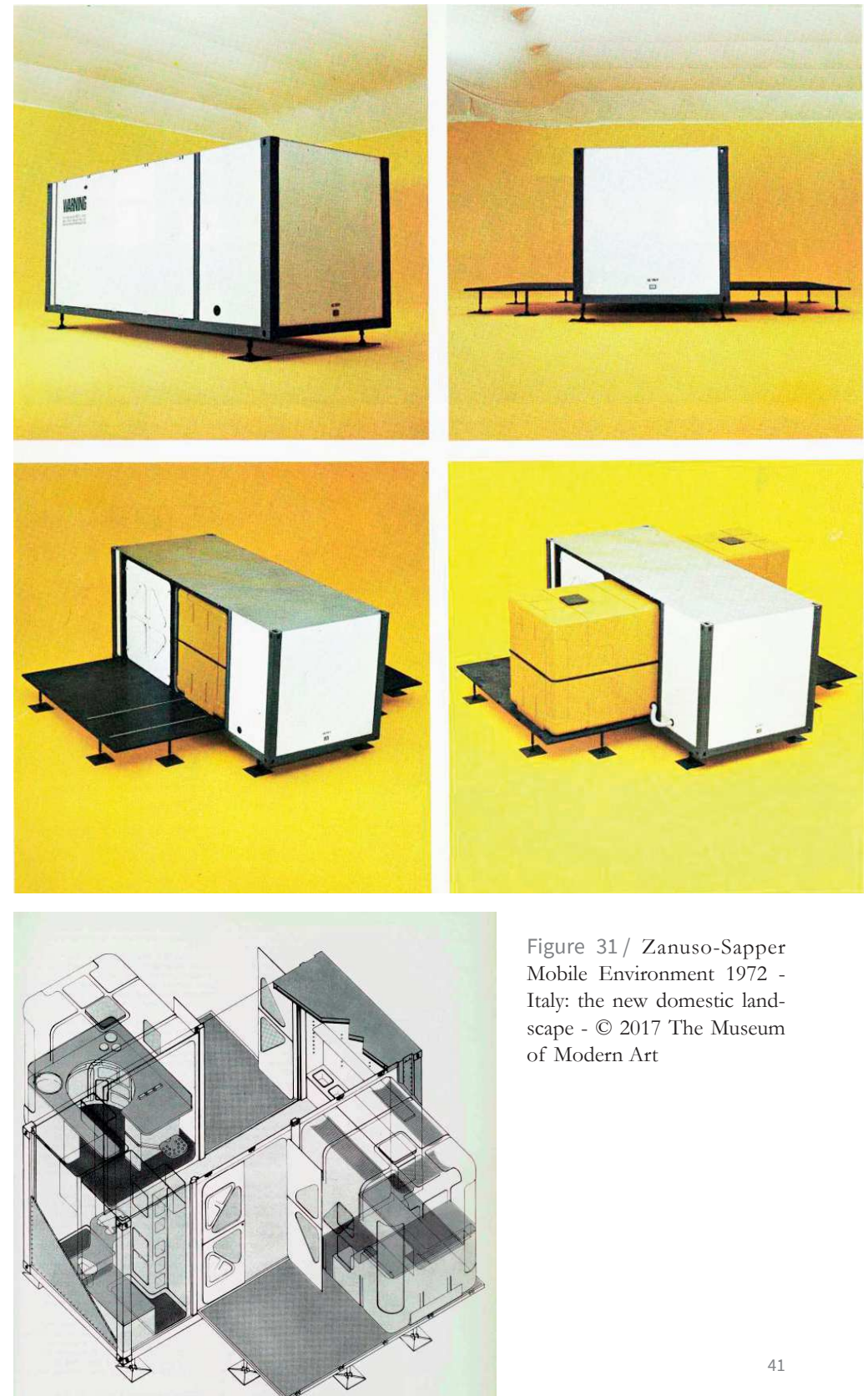

Figure 31 / Zanusso-Sapper Mobile Environment 1972 - Italy: the new domestic landscape - © 2017 The Museum of Modern Art



gories: 1) a chassis structure, built with partly modified standard steel and alloy container components, equipped with wing-doors and thermo-insulating skin; 2) a series of independent internal modules, that correspond to different domestic functions. These modules are contained within the chassis structure during transport.

Aggregation is obtained by the possibility of combining the unit with another container element, which can be equipped with similar internal modules, according to necessities, thus enlarging the original capacity, which is calculated for a couple, to the requirements of a family with children.

*Movement is conditioned by the circumstances intrinsic in transport, road conditions and safety, and demands a small, compact form. Repose means living, and thus maximum expansion of the potential in a living and technological space. So that which is strictly habitable in vehicles designed for the road often turns out as a miniature of real living conditions, with all functions reduced to the very poor scale dictated by the road. But we can surely overcome the limits of the mobile house by giving it a new form of expression, rediscovering in it the concept of the mobility of interior space, and its transformation and connection with other spaces.<sup>15</sup>*

This mobile environment is a lightweight capsule, expandable in four directions by means of telescoping runners, hinged floors and accordion walls. The surface of this environment, when open, is (including the terrace) over four times larger than its closed, transportable condition. Each of the four walls is outward movable and their outer surface serve 4 different functions: 1) double bunk beds, 2) wardrobe, 3) terrace (the wall itself folds down to form a terrace), 4) bathroom and kitchen. The capsule is carried by a small vehicle, which, when the capsule is on the ground, can be used independently by the family.

Figure 32 / ► Alberto Rosselli Mobile Environment 1972 - Italy: The new domestic landscape - © 2017 The Museum of Modern Art

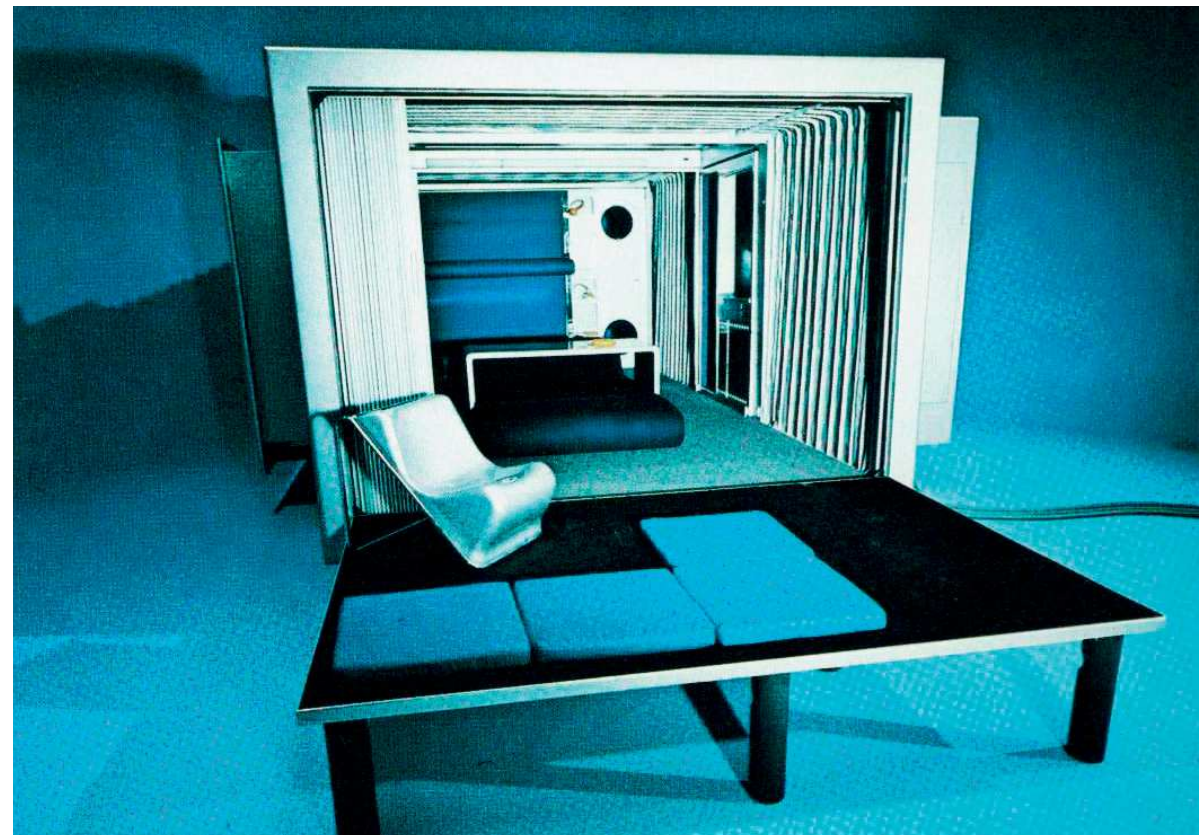
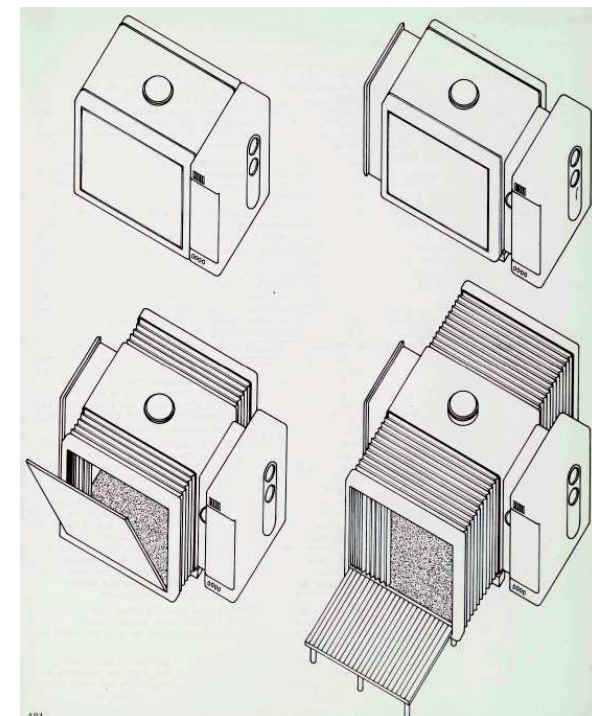

## 2.3 Contemporary production

New social categories, such as young workers, off-site students, low-income families, travellers, unemployed people, but also asylum seekers and disaster victims, bring new forms of temporary inhabiting use, characterized by flexibility, mobility and adaptability. In this scenario ephemeral architecture gives the right answer to attenuate social tensions, through construction solutions that are reversible, repeatable, lightweight and low-budget.

*PopUp house* is born from the idea of Corentin Thiercelin to build an entire building, floor, walls and ceiling by assembling insulation blocks, separated by LVL wooden boards. The blocks are sandwiched between the boards and tightened by means of through screws. It does not alter the polystyrene and thus allows the building to be completely disassembled and recycled. PopUp house is a construction solution that conceives the form of modular designing, starting from the smallest square footages to the largest ones for all users. This architecture concept has spread in non-seismic regions, like in France, where PopUp house was born.

Canadian tradition presents a typical local cabin for holidays, camping or other uses called *Bunkie*. Evan Bare, Nathan Buhler, Jorge Torres and Jim Moore think about a new way of conceiving Canadian cabin and give life to “Bunkie Company” to produce non-permit-request little houses.



Figure 33 / ◀ PopUp House France 2013 - © 2013 Elisabeth Montagnier - via [www.popup-house.com](http://www.popup-house.com)

Figure 34 / ▲ PopUp House France 2013 - © 2013 Elisabeth Montagnier - via [www.popup-house.com](http://www.popup-house.com)

Figure 35 / ▼ The Bunkie model Monarch, from left Manchester, Charlottesville and Meaford - © [www.thebunkie.com](http://www.thebunkie.com)

The idea is to create structural wood frames from an evolution of furniture elements. Each frame is composed by wood beam elements jointed by plywood. The internal holes are filled by insulating material to reduce transmittance. Bunkie house is an inhabiting module provided with lots of finishing covers and square meters.



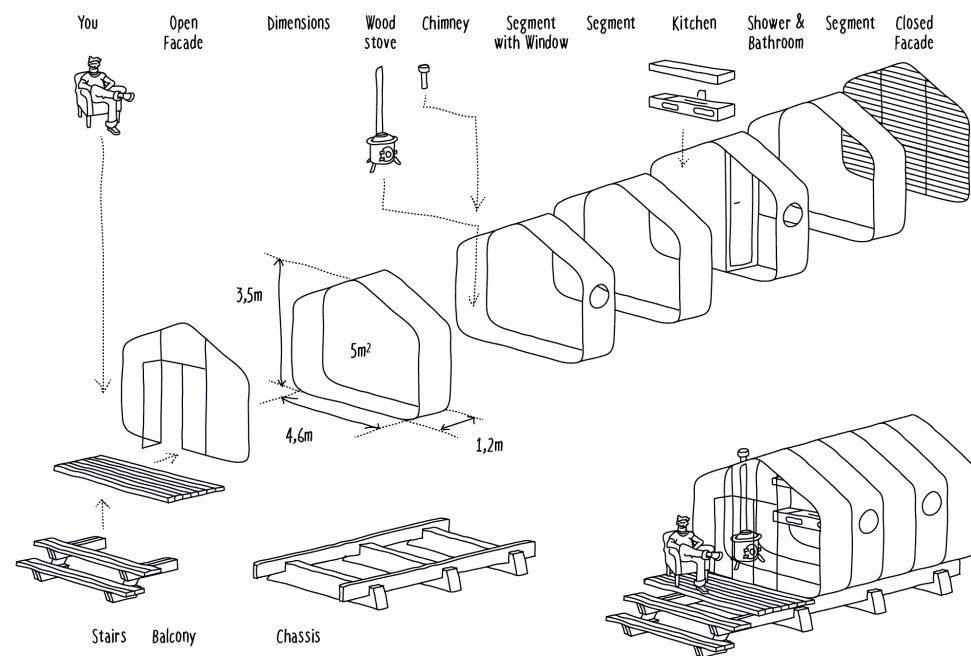

These segments are tube-shaped and made up of 24 layers of corrugated paper, wrapped around a house-shaped mould to achieve a rounded gabled form, before being bonded together with glue to create a load-bearing insulating shell. Each tubular component is 1,2 m long, and can be connected and disconnected to extend or reduce the length of the building. The cardboard is protected from weather by a waterproof but breathable film and finished with wooden cladding boards to create a weatherproof coating.

The structure does not require a foundation and it has a wood chassis to be linked to the ground. Slot-in sections include a kitchen, a shower and a bathroom, and they are provided with glazed or opaque facades.

An easy-construction architecture is *Wikihouse*, a repeatable house

Figure 36 / ◀ Wikkelhouse concept and prototype France 2013 - © 2018 Fiction Factory [www.wikkelhouse.com](http://www.wikkelhouse.com)

Figure 37 / ▼ Wikihouse CNC cutting and prototyping - © [www.architecture00.net](http://www.architecture00.net)



Fiction Factory is an Amsterdam collective which has developed a modular building system of cardboard components, that can be assembled in few days to form houses or offices.

*Wikkelhouse*, which means *Wrap House*, comprises a series of interlocking cardboard segments, whose weight is 500 kilograms.



model devoid of production constraints, because it is distributed in digital form everywhere, and implemented directly by users. Wikihouse is an open source project, promoted by the homonymous UK association, which aims to provide a new industrial standard developed by an open community of architects, engineers, manufacturers and other experts in

the building field.

The first Wikihouse technology is called *Wren*. Wren components are CNC manufactured using structural-grade timber-panel materials (typically plywood), that can be rapidly assembled to produce a structural chassis, onto which other components, such as cladding, windows, doors, can be fitted.

This version of the Wren structural language has been developed in *Grasshopper*, the parametric scripting plugin for *Rhino 3D*. This computational design platform is widely used in the design and construction industries, and is ideally suited to digital manufacturing.

Every designer, architect, builder, and so on, can develop the current version to improve the quality of the model, share every new idea with the community, and make the growth of the project.



Figure 38 / Wikihouse 4.0 at The Building Centre - © Margaux Carron via [www.architecture00.net](http://www.architecture00.net)

Figure 39 / ►▲ MED in Italy prototype - © 2012 University of Roma Tre and University La Sapienza - via [www.adidesignindex.com](http://www.adidesignindex.com)

Figure 40 / ►▼ MAI prototype - © Romano Magrone - via [www.ivalsa.cnr.it](http://www.ivalsa.cnr.it)

## 2.4 Three Italian cases

*MED in Italy*, by University of Rome, is a modular house designed for Mediterranean climate: it maximizes cooling and heating performances. It is obtained through a structural frame composed by easily-transportable wood lightweight elements, and by empty walls which can be filled with unpackaged heavy local materials, such as sand or gravel. MED in Italy won the Solar Decathlon Competition in 2012.



*MAI*, inhAbiting Ivalsa Module is a prototype of lightweight modular construction system made up of cross laminated timber panels. Each house is composed by five units of  $2,5 \times 4$  m<sup>2</sup> base and 3,5 m high, with two bedrooms, a bathroom, a kitchen, a living room, and two terraces of 16 m<sup>2</sup>. The project aims to receive LEED home certification for its environmental performances and sustainable production process.





## 2.5 Emergency house-kit

Since a long time, designers throughout the world have been interested in the theme of emergency architecture. Among these designers, the one who better centred the principles of emergency architecture is the Nippon architect Shigeru Ban, who has fixed the definition of the emergency building (i.e. repeatable, temporary and available), through the series of *Paper Log House*.

Figure 43 / Paper Log House Kobe 1995 - © Takanobu Sakuma - via [www.archdaily.com](http://www.archdaily.com)

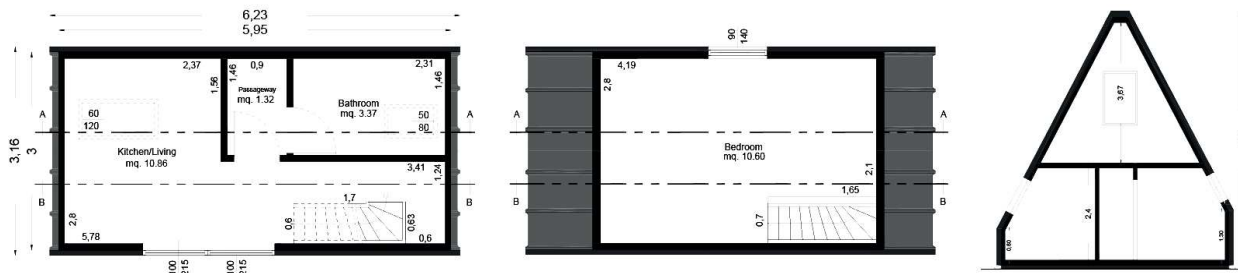

*MADi* is a foldable inhabiting module made up of wood insulating panels. These panels are jointed to each other with hinges that create two configurations of the building: compact shipping mode, and opened on site mode. This patented system<sup>16</sup>, developed by the architect Renato Vidal, aims to perform the installation of the house in few hours, by using mechanical means.

The structural frame is a load-bearing portal with an intermediate plan that behaves like a brace. An internal small stair connects the living area, at ground floor, with the sleeping area, at first floor.





Figure 44 / ◀ Paper Log House Kaynasli 1999 - © Shigeru Ban Architects

Figure 45 / ▶ Paper Log House Bhuj 2001 - © Kartikeya Shodhan - via [www.arch-daily.com](http://www.arch-daily.com)

His series of houses in paper tubes was made, for the first time, in 1995 in Kobe, Japan, soon after the earthquake that destroyed the city. That earthquake made over than 5.000 victims. Ban made a square-plan house of  $4 \times 4 \text{ m}^2$ , with four openings in the half of the sides. The structure is made up of paper tubes (with a diameter of 108 mm and a thickness of 4 mm), that are fastened through wooden clutches to a wooden treading surface, laid on beer cases full of sandy sacks. The roof is made up of paper tubes covered both outward and inward with a PVC cloth. The gap between the two plastic cloths can be ventilated during the warm seasons thanks to the side openings that improve the cooling; the gap is also an excellent insulation during the cool seasons, through the closing of the side openings. Shigeru Ban repeated his Paper Log House: in 1999 in Kaynasli, in the west of Turkey, after an earthquake that caused 20.000 victims and 200.000 evacuees; and in 2001 in Bhuj, India, after an earthquake of 7,9 magnitude that caused 20.000 victims and more than 600.000 evacuees.

Ikea's *Better Shelter* is an emergency shelter, fruit of a partnership between Ikea foundation and UNHCR, which started in 2010. The basic module, that Ikea has conceived for 5 guests, has  $17,5 \text{ m}^2$  of useful surface, with sides of  $5,68 \text{ m} \times 3,32 \text{ m}$ ; and it has a double pitch that can reach a maximum height of 2,83 m. The module has four windows and a door which can be blocked from both outward and inward. The structure of this housing module is a frame in galvanized steel, and its closing opaque panels are made up of poliolefinico polymers, outwardly treated against UV.

Figure 46 / Ikea's Better Shelter in Dollo Ado, a camp for Somali refugees in Ethiopia - © Åsa Sjöström





The lightness and easiness in assembling and dismantling the module make the Better Shelter an alternative solution to the tents of UNHCR. Moreover, Ikea's modules are repeatable and their parts can be easily replaced, if damaged. The assembly of a basic module can be carried out by 4 people in 4 hours, thanks to the accurate arrangements of components in the transport case which has a weight of 169 kg.

The Better Shelter module is fire- and waterproof, and it is guaranteed for lasting three years in mild climate conditions<sup>17</sup>.



Figure 47 / Hex House demonstration at the Nobel Peace Prize Forum - © www.hex-house.com

Figure 48 / ◀▲ 3D exploded model of Better Shelter - © bettershelter.org

Figure 49 / ◀▼ Installation of a Better Shelter in the camp Dollo Ado, Ethiopia - © www.ikeafoundation.org



*Hex House* is a project of Architects for Society (AFS). This house is an emergency basic module with a hexagonal plan of Fullerian memory, and it has been conceived for being aggregated with other identical modules.

The Hex House is conceived as a sustainable, rapidly deployable structure based on Structural Insulated Panel technology (SIP) which can be flat-pack shipped and easily assembled. It has the flexibility to be both a permanent and a temporary structure.

The structure's capacity can be easily modified with minimal disruption, this allows families to expand their space over time. Sustainable features like solar panels, passive cooling, rainwater harvesting and composting, and biogas toilets give families more independence, minimizes their carbon footprint and add operational savings.

The inherent structural stability of the hexagonal form and the rigid construction of SIP preclude the use of adding structural support. The

wall and roof panels are designed to be self-supporting and form a rigid structural shell. The basic building components are glue laminated beams (or aluminium) for the base, and Structural Insulated Panel for walls, floor and roof, which can be customized with various insulation values, depending on geographic area.

Figure 50 / ▲ Hex House planimetry distributions - © www.hex-house.com

Figure 51 / ▼ Hex House interiors - © www.hex-house.com

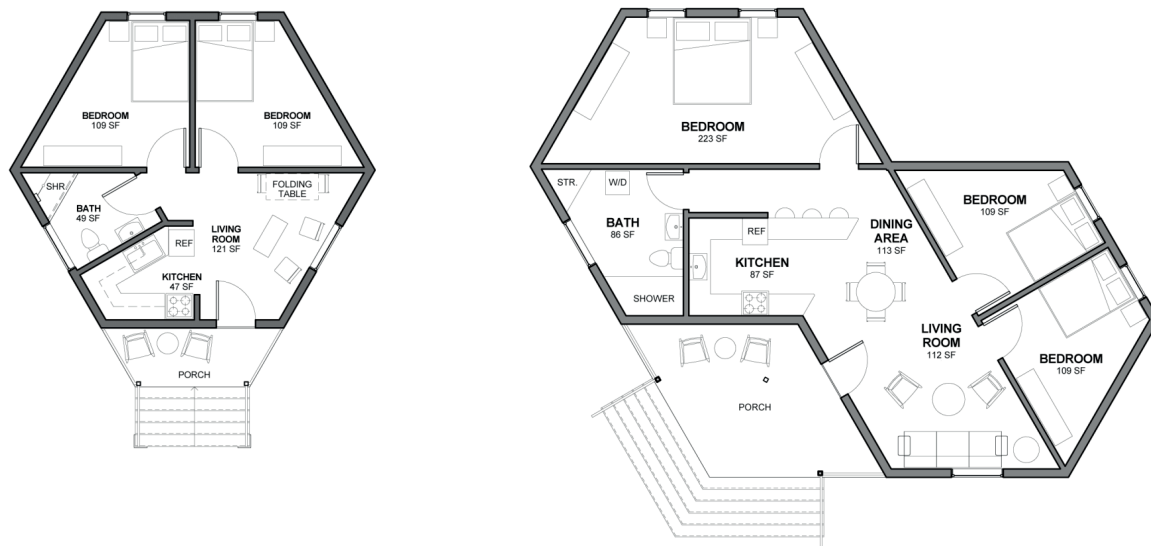

### Footnotes chapter 2

- 1 Faegre
- 2 Gambardella
- 3 Fuller R. B. (1940), patent No. US 2.220.482, Phelps Dodge Corporation New York
- 4 Gili Merlin
- 5 Fuller R. B. (1944), patent No. US 2.343.764, The Dymaxion Company inc & Wilmington Delaware
- 6 Wachsman K. L. and Gropius W. (1944), patent No. US 2.355.192, General Panel Corporation
- 7 Cagneschi C. (2009), p. 43-45
- 8 Edition Galerie Patrick Seguin (2014), JEAN PROUVÉ 8×8 DEMOUNTABLE HOUSE, 1944 – VOL. 2
- 9 Berthier S. (2015)
- 10 Hoffmann A.
- 11 Ambasz E. (1972), Release No. 41 - Italy: the new domestic landscape, The Museum of Modern Art
- 12 Ambasz E. (1972), p. 172, Italy: the new domestic landscape achievements and problems of Italian design, The Museum of Modern Art
- 13 ibidem
- 14 Ambasz E. (1972), Release No. 37 - Italy: the new domestic landscape, The Museum of Modern Art
- 15 Ambasz E. (1972), Release No. 42 - Italy: the new domestic landscape, The Museum of Modern Art
- 16 Vidal R. (2015), patent No. US 8.997.406 B2
- 17 Better Shelter org (2017)





## 3/ design criteria

The definition of “habitability” is the beginning of Chapter 3. Habitability depends on duration, motivation and quality of the occupation of a place. Starting from these considerations, it is presented a comparative analysis of the case studies of Chapter 2 and of Civil Protection solutions guideline. Focusing on some recurrent criteria, it is developed a program of emergency design strategies.

The outcome of this chapter is a design tool useful for next design process, built by matching emergency the design strategies and the bioclimatic ones.

### 3.1 The meaning of habitability

The objective of defining the characteristics of a dwelling module destined to emergency conditions leads to conceive the thin equilibrium between scope and duration of the inhabiting in a place and the satisfaction of inhabiting that space. As Fraser says:

*It is apparent that what is habitable for one purpose may not be habitable for another, that what is habitable for a short duration is not necessarily habitable for a prolonged duration, and that even the most comfortable prison could become intolerable after a time.*

#### **There is no standard of habitability**

#### **Habitability is a variable quality**

The combination of personal, social and environmental factors, in a definite time of occupation and for a definite scope of occupation, represents a point, that is established in a continuum and that divides the habitable from the non-habitable<sup>1</sup>.

This point is not steady, but moves arbitrarily according to people's sense of quality, in terms of physiological homeostasis, social relationships and productivity.

A space habitable for a short time might not be habitable for a long time; a space habitable for a young couple might not be habitable for a family: a shelter habitable after a disaster might not be habitable after many years, and so on<sup>2</sup>.

Dan Soen distinguishes various levels of habitability, depending on occupants' needs, referring to Clare Cooper scheme<sup>3</sup>.

Humans' principal needs are food, water and a shelter. Therefore, the first level of habitability is having a roof over the head. When this need is satisfied, the need of safety starts, in terms of building intrinsic safety and security against external attacks.

After shelter and safety need satisfactions, people focus on comfort



Figure 52 / Al Jamea'a Camp, Baghdad, 2014 - © Sebastian Rich - via bettershelter.org

and efficiency of the dwelling. When comfort and convenience are satisfied, they look for socialization and self-expression. Finally, when all previous needs are satisfied, the occupants start to concentrate on aesthetics of the dwelling and of the context.

Habitability and comfort are not the same thing. The second one plays an important role in the definition of the first one. About habitability, Massimo Foti points out some aspects of the theme just starting from comfort.

*If habitability neglects any trace of comfort, one will tend to play on the maximum capacity of adaptability of man; on the other hand, a good*

*comfort will contribute to achieving excellent habitability, allowing the man to concentrate his energies in carrying out the tasks that are required to him. Comfort is a relative aspect of habitability, with the increase of which the minimum environmental level of habitability increases.*

Adaptability and customizability are other two values for habitability. As much people can intervene in the place where they live (modifying and adapting it, according to their desires), as that place will be habitable for them. New developments in technologies are going to overcome traditional limits and achieve human desires by transforming buildings and places according to actual needs, for multiple and unpredictable usages.

*No inhibitions should be placed upon the individual's desire to build! Everyone ought to be able and compelled to build, so that he bears real responsibility for the four walls within which he lives.*

Hundertwasser 1958<sup>4</sup>

Figure 53 / How to fix design - © Artwork by Atipus - via 99u.adobe.com

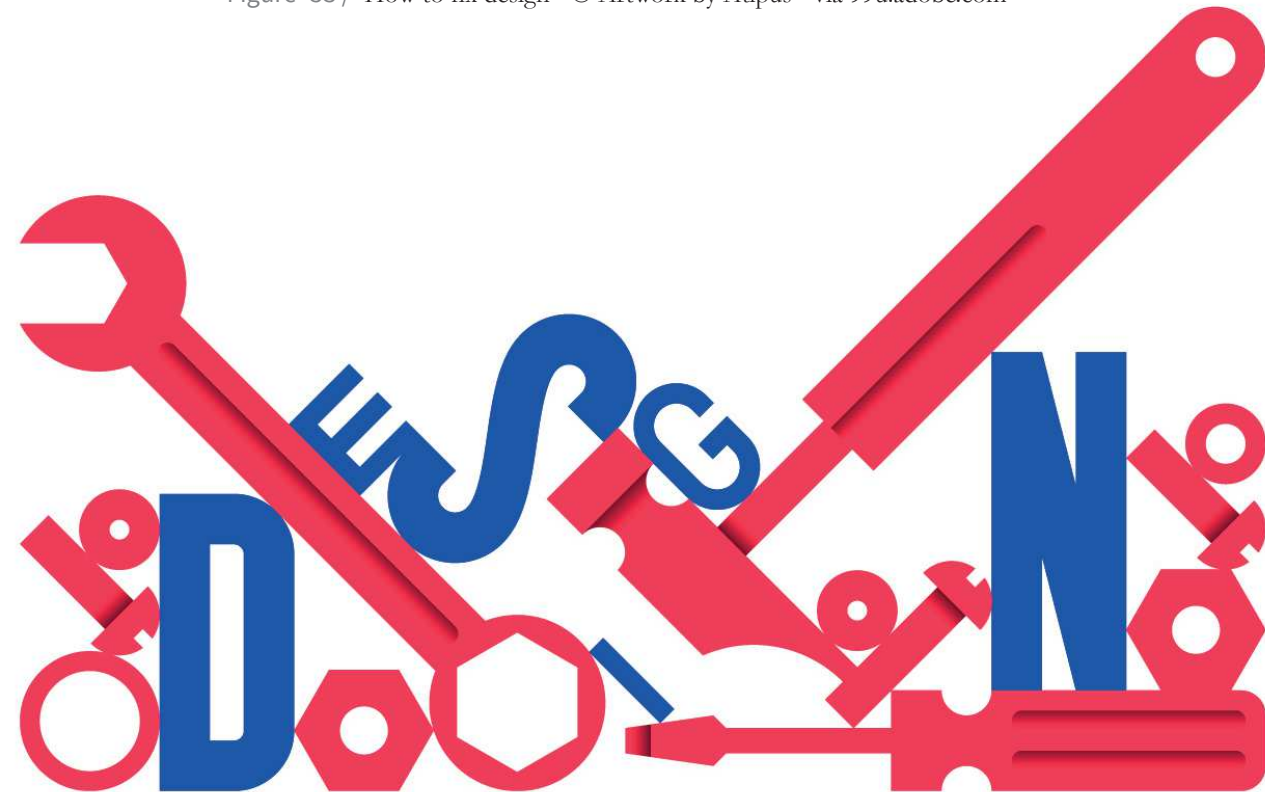

Foti remarks

*It is a question of personalization, appropriation of space, freedom of choice for the user, architectural variety.*

Last but not least, the capability of an architecture product of evolving during the use is the capability of increasing its habitability as function of changing of owners, climate conditions, tastes. This capability involves at least two issues:

- Transformation not predicted by project: functional readjustment,
- overcoming of original destination
- Transformation predicted by project:
  - The transformation is feasible only at the time of project, by choosing a solution rather than another one
  - The transformation is directly feasible by the owner
  - The transformation is feasible only by the intervention of experts

## 3.2 Civil Protection technical guideline

The designing of prefabricated shelter, destined to displaced people and refugee, requires the preliminary individuation of operating conditions, comfort needs, transportation and installation procedures.

The design studies of the present work are based on the guidelines of the Italian authority for emergency, and the goal of this research is to produce an affordable and comfortable corrugated cardboard emergency housing module according to Civil Protection operative instruction.

In 2005, with a Decree of Chief of Civil Protection, it was provided an operative manual<sup>5</sup> for designing in emergency. The objectives of the manual are:

- defining the framework of existing regulations, even configurations and performances that are related to the installations in the areas dedicated to emergency shelters;

- defining the technical and operational guidelines for the design and construction of prefabricated shelter areas according to urban sustainability, environmental and economic criteria;
- providing tools to support the design and implementation of shelter areas directed to the actuators and to the area managers, both in routine condition and in emergency;
- organically collecting and presenting, and specifically finalized to the field of chosen action, the needs and adoptable design solutions;
- formulating proposals for the organization of spaces and for their preparation, as well as their functional connection to other territorial issues;
- limiting the costs of implementation and management of space, while ensuring an adequate level of service;
- establishing certain performance standards.

According to these premises, the manual contains the plan of operations after a disaster (such as natural disaster, shipwreck, and so on) and the employment of various types of available shelter solutions as function of post-disaster phases.

Firstly, it is important to establish safety conditions for victims, who might be in shock, dismay, disbelief. The predisposed safe areas could accommodate victims for the first hours after the event, giving them sanitary assistance and essential needs. During the next days, when the state of confusion decreases, gradually the victims tend to recover the sense of belonging and the ability to process behavioural response mechanisms. In this phase tents or caravans for temporary housing are provided, in predisposed areas like parks or plains.

The Civil Protection tents are quickly available solutions, easily transportable and easily to install.

There are two categories of emergency tents, different for their structural member types: self-stable and pneumatic.

Self-stable tents are provided in two versions in order to their number of span, respectively 3 or 4. This type of tent is installed by mounting structural metallic arches and then fixing outer and inner plastic fabrics by tending them with cords and pickets.

Pneumatic tents are installed by pumping air into structural hollow arches, after the ground preparation with plastic grill and insulating fabric.

Ministry tents are another kind of self-stable tents provided by the Ministry of Internal affairs.

	Packed size [cm]	Packed weight [kg]	Net size [cm]	Gross size [cm]	Occupants [n°]
Self-stable tent PC/08 3 arches	na	430	530×600×280h	950×1150×280h	12
Self-stable tent PC/08 4 arches	na	535	530×800×280h	950×1350×280h	16

Civil Protection Self-stable tents - [www.ferrino.it](http://www.ferrino.it)

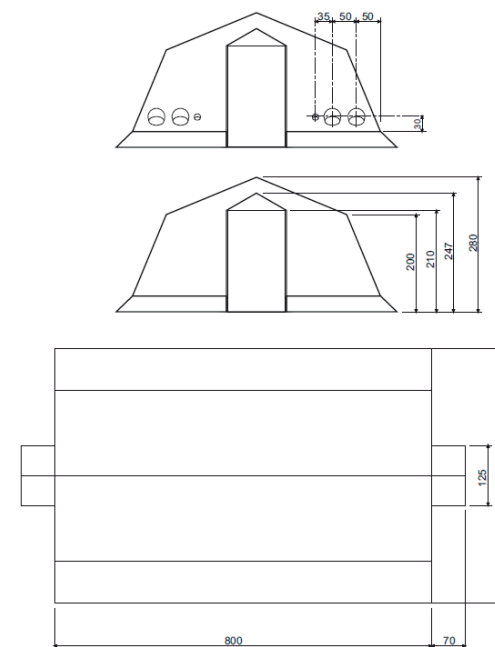

Figure 54 / Self-stable tent PC08 4 arches

Figure 55 / Detailed view of Self-stable tent PC08 4 arches

	Packed size [cm]	Packed weight [kg]	Net size [cm]	Gross size [cm]	Occupants [n°]
Pneumatic tent PC/07 3 arches	118×169×144h	500	560×515×280h	860×950×280h	12
Pneumatic tent PC/07 4 arches	118×169×144h	703	560×755×280h	860×1300×280h	16

Table 1 / Civil Protection Pneumatic tents - www.ferrino.it



Figure 56 / Pneumatic tent PC07 4 arches  
 Figure 57 / Detailed view of Pneumatic tent PC07 4 arche  
 Figure 58 / Ministry tent PI88 - www.moproc.com

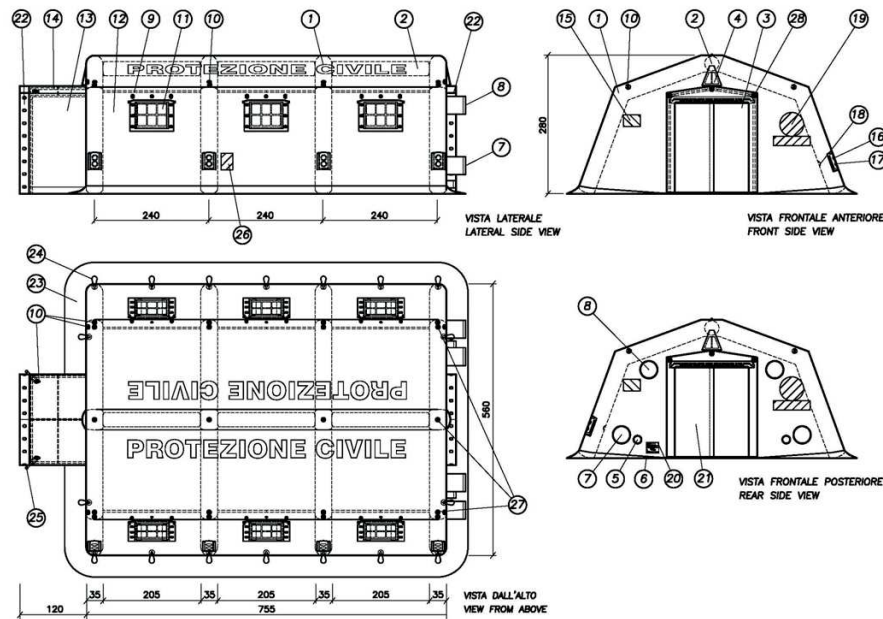

The containers, intended as a standardized module used for housing or social needs, represent the most common device used to cope with

	Packed size [cm]	Packed weight [kg]	Net size [cm]	Gross size [cm]	Occupants [n°]
PI 88	na	233	620×455×300h	750×750×300h	12

Table 2 / Ministry tents



emergency conditions, thanks to their advantages, in terms of: functional autonomy, speed of delivery, transport and positioning, possibility of recovery and subsequent storage, ease of maintenance.

The technical specifications are derived from those used for the supply of containers for civil protection, during the seismic crisis that hit the regions Marche and Umbria in 1997.

The technical specifications of containers regard mechanical and environmental performances, also fireproofing, and finishing equipment. The

	Area [m <sup>2</sup> ]	sqm per person [m <sup>2</sup> ]	Internal size [cm]	External size [cm]	Occupants [n°]
ISO 20	18	9-18	275×580×220h	299×605×274h*	1-2
ISO 40	36	4,5-9	275×1195×220h	299×1219×274h*	4-8
ISO 40 dis	36	7,2-9	275×1195×220h	299×1219×274h*	4

Table 3 / Housing containers ISO - \* Based on ISO containers enlarged to 299 cm, represent exceptional transport, because they exceed the outline of 250×1200×400 cm defined by art. 61 of the Highway Code (Law Decree n° 285/92 and amendments and additions), who need the authorizations referred to Article. 13, paragraph 1 of the Implementing Regulation of the Highway Code (Presidential Decree No. 610/96) and those issued by the Prefecture for reasons of necessity and urgency.

	Area [m <sup>2</sup> ]	sqm per person [m <sup>2</sup> ]	Internal size [cm]	External size [cm]	Occupants [n°]
Mod. A	18	9-18	222×711×225h	244×733×260h	1-2
Mod. B (2×A)	36	7-12	444×711×225h	488×733×260h	3-5
Mod. C (3×A)	52	6,5-9	666×711×225h	732×733×260h	6-8

Table 4 / Housing containers for standard transportation

minimum transmittance is fixed in 0,38 W/m<sup>2</sup>•K for walls and 0,52 W/m<sup>2</sup>•K for floor. The mechanical behaviour of a standard module ISO 40 presents permanent loads of about 55,5 kN and variable loads of about 37 kN.

Housing needs of displaced people, in case of long time reconstruction, can be complied with prefabricated houses, that ensure greater comfort

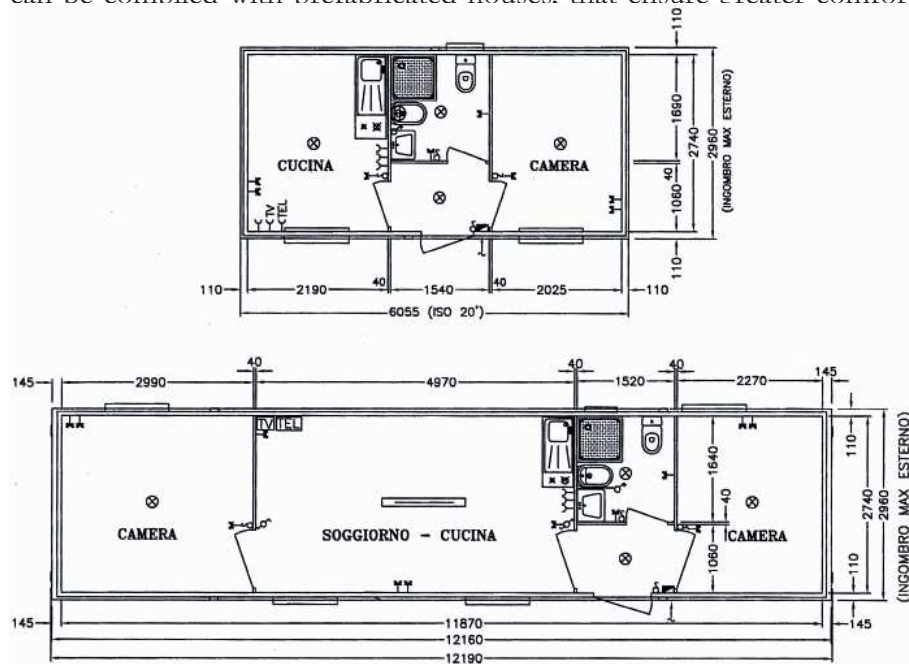
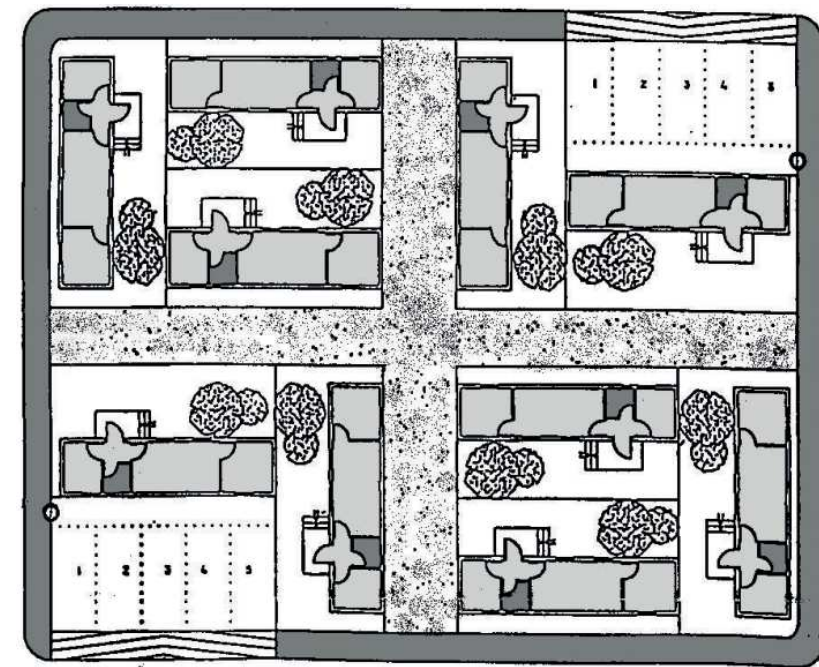
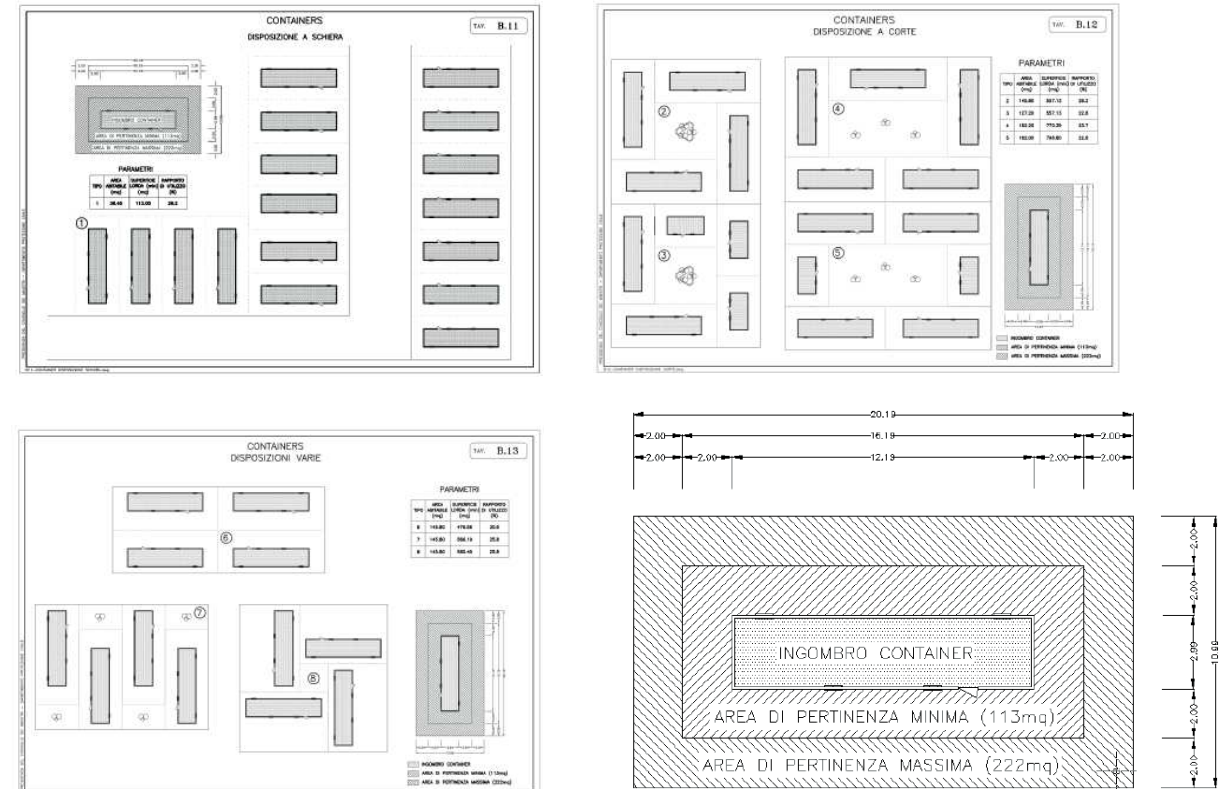
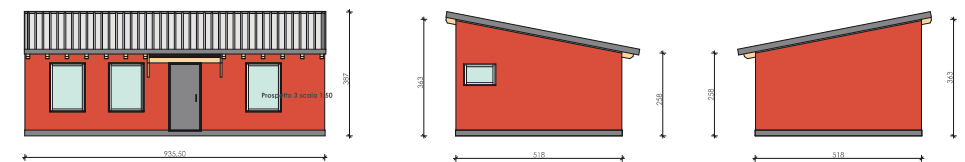
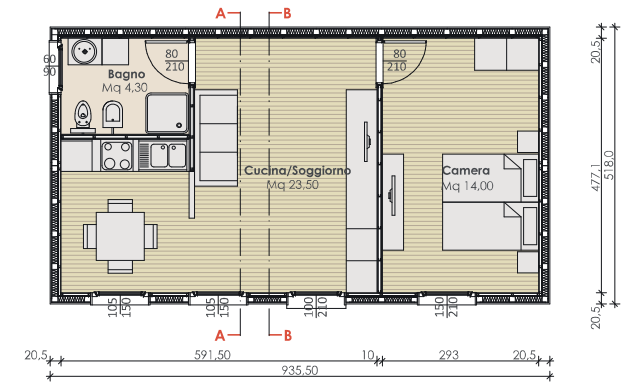
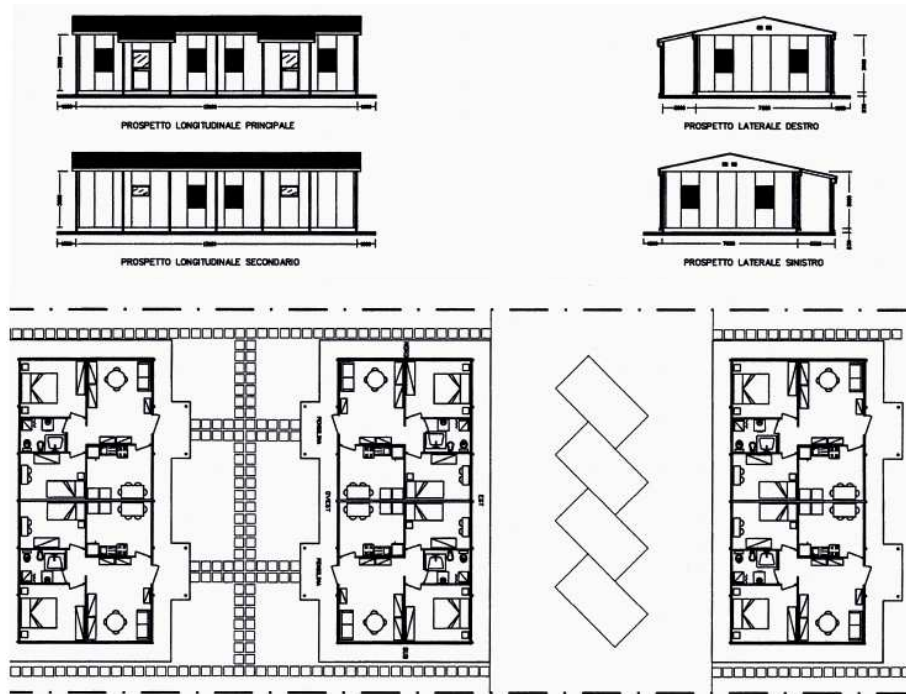

Figure 59 / Container ISO 20 and ISO 40, 2003 - Guideline for design Regional Department of Civil Protection Eastern Sicily

Figure 60 / ►▲ Aggregation schemes of containers - Annex B - Technical manual for the preparation of shelter areas for prefabricated structures of civil protection - 2005 Presidency of the Council of Ministers Department of Civil Protection

Figure 61 / ►▼ Open court aggregation scheme, 2003 - Guideline for design Regional Department of Civil Protection Eastern Sicily





than container, and overall functional standards as common houses. These prefabricated dwelling are more expensive than containers, and the installation time is much longer. They often need a reinforced concrete base due to the construction techniques. There are several construction types on the market: from wood to concrete, to fiberglass, the metal sheet with a core of insulating plastic material.

The technical specifications are derived from those used during the crisis earthquake that hit Molise in 2002.

In 2014, Italian Department of Civil Protection launched a call through Consip spa, the public company of Ministry of Economy and Finance,

	Area [m <sup>2</sup> ]	sqm per person [m <sup>2</sup> ]	Internal size [cm]	External size [cm]	Occupants [n°]
DPC 40	40	20-40	na	na	1-2
DPC 50	50	12-16	na	na	3-4
DPC 70	70	12-14	na	na	5-6

Table 5 / Housing modules

Figure 62 / Photo and technical views of Prefabricated housing modules M.A.P. - © www.frimat.eu

Figure 63 / ◀ Emergency settlement of DPC, 2003 - Guideline for design Regional Department of Civil Protection Eastern Sicily

for the providing of emergency housing solutions (In Italian: *Soluzioni abitative di emergenza* - SAE). The first provider that won the call was CNS (National Consortium of Services) with COGECO 7 srl. The award of the call was followed by the signing of a framework agreement between the CNS and the Department for the supply, transportation and erection

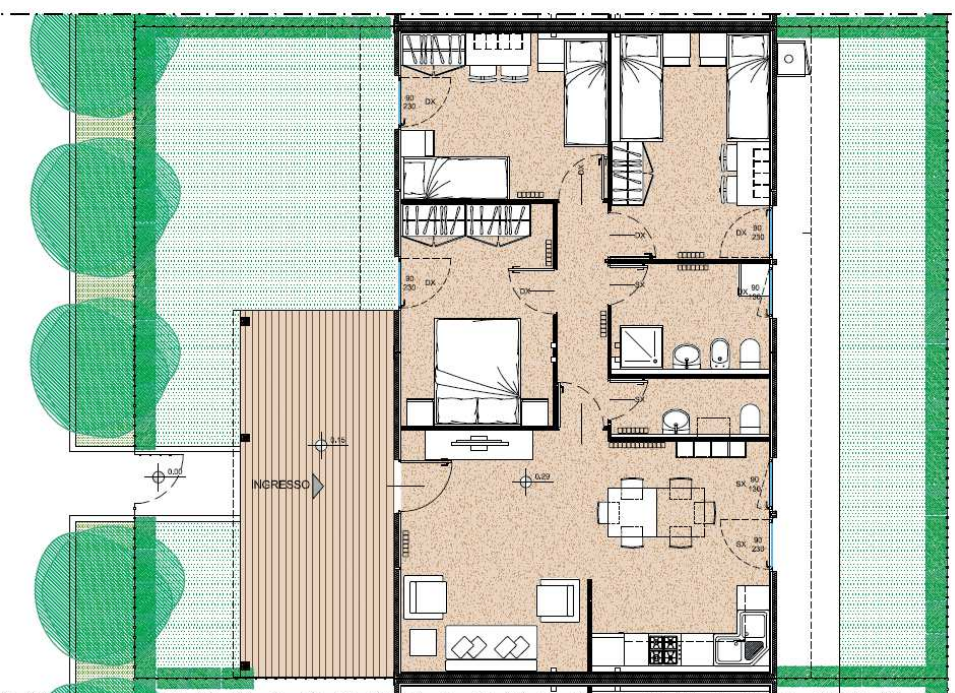
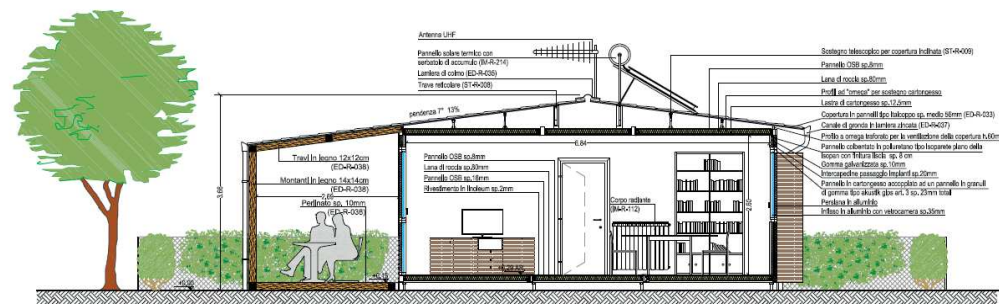

of emergency housing solutions for three lots of 600 units, for 1800 houses.

The housing solutions, identified by the Consortium on the basis of the technical specification of the call, consist of modules of 40, 60 and 80 m<sup>2</sup>, mutually combinable, suitable for all weather conditions and designed to be accessible to disabled people. Designed according to seismic, safety, hygiene and environment laws, SAE are also predisposed to be disassembled and reused. It is expected that the dwelling were equipped with central heating system - consisting of a condensing boiler and radiators - and with furniture and appliances.

### General specification of SAE

The S.A.E., not prefiguring any condition of permanent residency, must have a useful life of 10 years, and must be removable, flexible and adaptable in case of conversion on site for other use destinations.

The S.A.E. have to be turnkey provided, complete of furniture, complements and all necessary equipment to make the building ready for use and operation. They also have to be provided of accessories and necessary equipment to be connected to hydric distribution, sewer, electricity, phone line and gas.

	Area [m <sup>2</sup> ]	sqm per person [m <sup>2</sup> ]	Internal size [cm]	External size [cm]	Occupants [n°]
SAE 40	40 ± 3%	20-40	na	na	1-2
SAE 60	60 ± 3%	15-20	na	na	3-4
SAE 80	80 ± 3%	13-16	na	na	5-6

Table 6 / Inhabiting emergency solutions



Figure 64 / ◀▲ Technical views of 80m<sup>2</sup> S.A.E. (emergency housing solution) - © CNS Consorzio Nazionale Servizi Soc. Coop. and COGECO 7 srl

Figure 65 / ◀▼ Last construction phases of S.A.E. in the regions of center of Italy after the earthquake of 2016 and 2017 - www.emergency-live.com



### 3.3 Comparative analysis

In order to demonstrate the effectiveness of an emergency house-kit made of cardboard, it is useful to do a contextual analysis of existing housing systems, that were been already described in the previous chapter, by taking into account similarities and differences.

The comparison is a valid strategy for better understanding the parameters that play an important role in the designing process. Starting from basic information, such as building date, country, size of the dwelling, materials, time of on-site operations, to focus on some core themes of the project, e.g. the layout of the settlement in relation with the number of occupants.

Table 7 / Comparison between existing housing systems

Name	PC 08 3 arches	Container 20ft	S.A.E. 40	PaperLog House	Better Shelter	The Bunkie	Hex House	Microhouse	Wikkelhouse	M.A.Di.	Parameters
<b>General</b>											
Year	NA	NA	2017	1995	2010	2014	2017	2014	2017	2018	
Status	Active	Active	Active	Ended	Active	Active	Active	Active	Active	Prototype	
Production/ designer	several	several	CNS Cogeco 7	Shigeru Ban	Ikea	The Bunkie CO.	Architects For Society	WikiHouse Foundation	Fiction Factory	Renato Vidal	
Country	Italy	Italy	Italy	Japan	Sweden	Canada	USA	UK	Netherlands	Italy	availability
Size	562×515×h280cm	299×605×h279cm	40m <sup>2</sup>	400×400cm	332×568×h283cm	305×320×h335cm	47,4m <sup>2</sup>	NA	460×600×h350cm	316×623×h675cm	flexibility
Area per person	7,95/5,3m <sup>2</sup>	7,96m <sup>2</sup>	20m <sup>2</sup>	≈ 8m <sup>2</sup>	≈ 9m <sup>2</sup> /5m <sup>2</sup>		11,8m <sup>2</sup>		≈ 12m <sup>2</sup>		flexibility
<b>Construction</b>											
Product time/ providing time	NA	40/15 days	100 per month	NA	NA	NA	NA	NA	8 month	20 weeks	providing
Building Time	1 day	1 day	variable	NA	1 day	2-3 days	7 days	NA	NA	2 days	providing
Method	Civil protection	NA	Specialized	Involved users	Involved users	Specialized	Specialized	Involved users	Specialized	Specialized	assembly
Transportation	Container ISO	Container out of standard	Truck	Local production	Container or postal package	Container ISO	Container ISO	NA	Truck	Truck	transportation
<b>Material</b>											
Base	Levelled ground	Levelled ground	Concrete heavy pad	Levelled ground	Levelled ground	Concrete light pad	Levelled ground	Simple pad foundation	Levelled ground	Levelled ground	reversibility
Structure	Fabric	Metal	Steel	Paper tube	Steel and plastic	Wood	SIP	Plywood	Cardboard	Wood	sustainability
Glazing	Plastic	Aluminium and glass	Aluminium and glass	Raw wood	Plastic	Aluminium and glass	Wood and glass	Various types	Wood and glass	NA	safety and comfort
Systems	Centralized Heat cooling pump	Heat cooling pump	Heat cooling pump	NA	Heat cooling pump	NA	Heat cooling pump / PV	NA	NA	Heat cooling pump	sustainability
<b>Performance</b>											
Wall Transmittance	NA	U = 0,60 W/m <sup>2</sup> K	U = 0,40 W/m <sup>2</sup> K	NA	NA	NA	U = 0,30 W/m <sup>2</sup> K	various values	NA	various values	safety and comfort
Roof Transmittance	NA	U = 0,40 W/m <sup>2</sup> K	U = 0,40 W/m <sup>2</sup> K	NA	NA	NA	U = 0,30 W/m <sup>2</sup> K	NA	NA	NA	safety and comfort
Waste	none	none	partial	none	none	none	partial	partial	partial	NA	sustainability
Cost [€/m <sup>2</sup> ]	NA	NA	1100 SAE + 7000 other costs	118	NA	about 5500	950	1160	about 1800	1340	sustainability

The Table 7 is built starting from the information collected in the previous chapter. The information are selected by basing on their recurrence in each case study:

- General information
- Materials information
- Performance information
- Cost.

The reading of the table highlights offers several characteristics that could be fixed as design parameters:

- Transportability
- Assembly
- Availability
- Flexibility
- Safety and comfort
- Reversibility
- Sustainability.

### 3.4 Emergency design strategies

The aim of this research is to propose a prefabricated housing module made up of cardboard that can fill the gap between the first emergency housing solution, the tent, and the second one, the S.A.E.

This solution must have better performance than the tent or the S.A.E. by paying longer times for on-site operation than the tent, but much lower than the S.A.E.

How can emergency housing modules be designed? That is the main question of this research. The objective is not to provide rules, but to present a scheme of central aspects that an emergency design has to deal with. The collection of design criteria of emergency design is a helpful tool for better understanding the decisional process of designing an emergency house-kit

*The challenge lies in defining the relevant goals within this complex catalogue of criteria and to find the right balance between requirements that are sometimes contradictory.*

William McDonough and Michael Braungart<sup>6</sup>

The design of an emergency house-kit is an interactive design in which recursive procedures allow continuous checking of the project, against the superordinate requirements, compared to linear design in which, through the process, the problems have to be eliminated in order to keep as close as possible to the initial draft.

- Transportability
  - type of transportation
  - packaging
  - handling
- Assembly

- skills
- tools
- technical assembly manual
- Availability
  - available base material
  - easily providing
  - storage
- Flexibility
  - short term adaptability
  - long term adaptability
  - customizable
- Safety and comfort
  - mechanical performances
  - thermophysical performances
  - fireproofing and waterproofing
- Reversibility
  - modification of site
  - resetting
  - reuse cycle
- Sustainability
  - efficiency
  - consistency
  - sufficiency

### Transportability

The first criteria of emergency house-kit design is transportability.

The fundamental need, of faster and easily housing intervention, passes through the maximization of usage of standard transportation and maximization of transportable quantity. The usage of standard transportation allows to reduce costs and time of put-into-opera of the dwelling units, from the storage or production site to emergency areas, where, reducing the encumbrance volume of packaged dwellings, it increases the

quantity of emergency houses available with the same transportation unit. Choosing a mountable house-kit, instead of an already mounted house, allows to reduce costs of heavy construction site vehicles. This costs and time reducing becomes significant if the house-kit construction system does not require high installation time or skilled workers.



Figure 66 / Containers ISO 1C - © Giambattista Artesi - Exercise Basilicata 2012

### *Type of transportation*

The best choice of standard transportation is the container ISO 20ft because of its avio-heli transportability, also ship and wheel transportable.

The container ISO 20ft has a gross load volume of  $6.048 \times 2.438 \times 2.591$  mm and a net volume of  $5.898 \times 2.391 \times 2.352$  mm.

Another container ISO is 40ft one. This container is not avio-heli transportable, but only by ship and wheel.

The container ISO 40ft has a gross load volume of  $12.192 \times 2.438 \times 2.591$  mm and a net volume of  $12.132 \times 2.391 \times 2.352$  mm.

Non-standard types of transportation might cause the exceedance of

the road transport limits, in terms of encumbrance and weight, with increasing of costs and time for authorizations.



*Packaging*

Reducing the size and the weight of un-mounted components is the best way to increase the effectiveness of the transportation, by the maximization of the quantity available on the construction site with the same transport unit.

Even the packaging has to be standard in order to avoid waste of loading space, and to allow the usage of standard mechanical tools, such as forklifts or pallet trucks.

The standard pallet sizes are 80 × 60 cm, 120 × 80 cm and 120 × 100 cm.

Figure 70 / ◀ Better Shelter pallet packaging, 2018 - © Saskia Baar - via twitter.com  
 Figure 71 / ▶ Better Shelter packs - © Better Shelter org - via www.youtube.com



Figure 67 / ◀ CH-47 Chinook helicopter with container ISO 20, 2013 © U.S. army Capt. Peter Smedberg - via archive.defense.gov  
 Figure 68 / ▶ C-130J Hercules II - © Ministero della Difesa - www.aeronautica.difesa.it  
 Figure 69 / ▼ C-130J and C-130 J-30 size comparison



*Handling*

It is hard to think at a totally manual process of loading and unloading from containers. The best way of planning a process of loading and unloading is to break up the process into levels, and therefore break up the packaging. In the level of loading the container, on production or storage

sites, it might use mechanical tools, e.g. forklift or pallet trucks. Often, in the emergency area, there are not mechanical tools. For this reason, the level of unloading the packaging from the container must be manually feasible. The unpackaged materials must not exceed in weight the maximum load for a safe handling.



Figure 72 / Better Shelter handling - © Better Shelter org

### Assembly

The criteria of assembly concern the definition of all the strategies to speed and simplify the operations on construction site. In emergency area people do not know which facilities can be found to activate construction operations. There might not be energy, both electric and fuel, there might not be accessibility for heavy vehicles on site, there might not be skilled workers, and so on. Thinking of a construction process that involves simple operations and easily available resources is the best way to increase the range of feasibility of a housing solution.

### Skills

A simple construction process allows to employ low-skilled workers on operations. They could be the victims of the emergency themselves. That has the direct objective of involving them on building their own house, and the indirect effect of reactivating the process of recovering.



Figure 73 / Paper tubes emergency shelters for the UNHCR at Byumba Refugee Camp in Rwanda, 1999 - © Shigeru Ban Architects - via [www.indesignlive.sg](http://www.indesignlive.sg)

### Tools

The tools of emergency construction operation have to be easily available and easily to use. Including a construction tool kit in the packaging is a good strategy to simplify the assembly.

Tools have to be easy to use and easy to handling. A small fuel electricity generator must be able to supply recharging of power tools.

### Technical assembly manual

The strategy of involving the victims in the construction operations

can be obtained by including an assembly manual that explains in simple passages all the construction phases with attention to: staff employed, tools, objective and results.

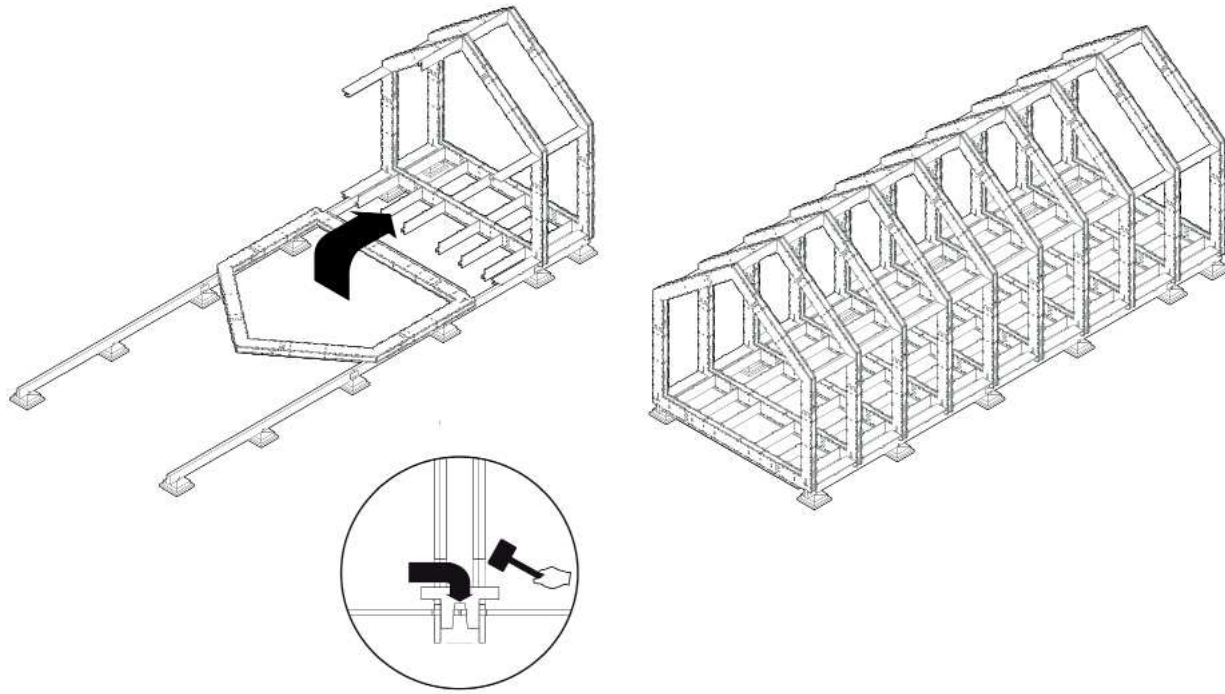

Figure 74 / Extract from assembly manual of Micro House - © wikihouse.cc

### Availability

The theme of resource availability in emergency is a crux in the planning of an emergency construction intervention. E.g., The Italian Civil Protection draws the contracts up, with the providers, basing them on their productivity capacity. The productivity represents the quantity of housing solutions that each provider is able to offer on site in the turnkey form. This quantity is on average of 100 units per month for each provider. When the providing order is confirmed and the site is ready for the installation, the providers have to deliver on site, in 30 days, the 50% of the housing modules and the rest in the next 30 days.

### Available base material

The choice of a construction system has to take into account the availability of base materials. The productivity may increase due to the quantity of available base materials.

### Easily providing

This topic is the direct consequence of transportability issues. Simplifying the providing operations means creating a providing plan that contains: packaging design, packaging specs and classification of packing units.

### Storage

The production capacity is not the only necessary condition for a good providing process. The storage capacity is another fundamental topic of the availability: a large quantity of packaged units must take place into storage sites.

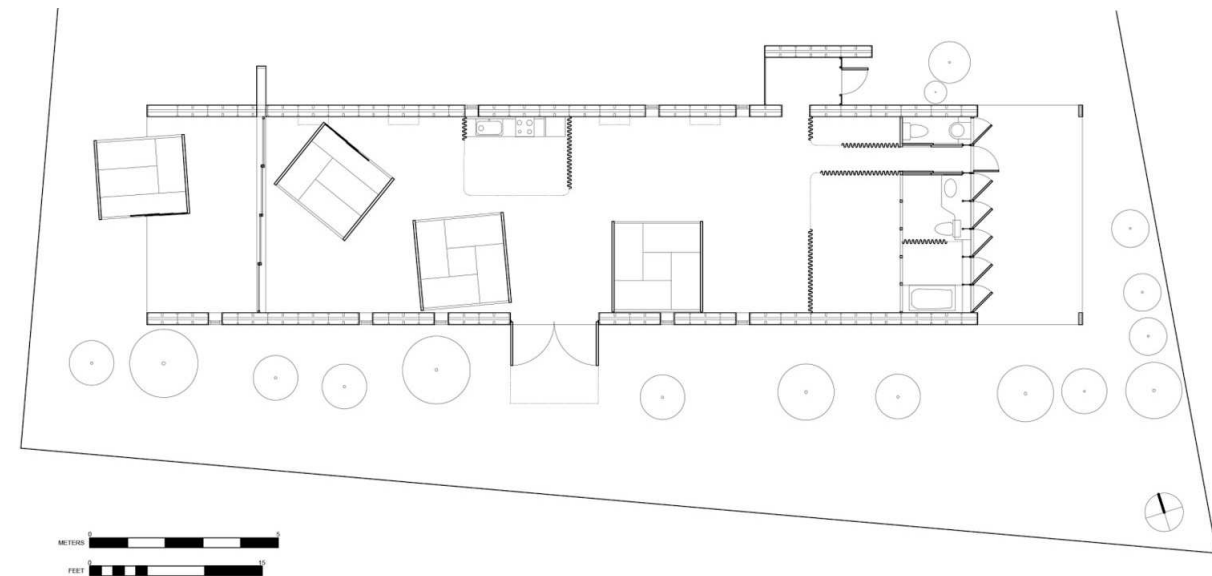

Figure 75 / Plan of Naked House - © ArchEyes, February 10, 2016 - archeyes.com



Figure 76 / ▲▼ Interiors of Naked House, Shigeru Ban 2000 - *The owner wanted a house that “provides the least privacys so that the family members are not secluded from one another, a house that gives everyone the freedom to have individual activities in a shared atmosphere, in the middle of a unified family”* - © Hiroyuki Hirai - via archeyes.com



## Flexibility

Flexibility means the capability of a building to be adjusted according to the users' requirements after a usage cycle. As described by Drexler, El Khouli<sup>7</sup>

### *Short term adaptability*

The capability of reacting to short- and medium-term demands without the need of conversion. An emergency house-kit must be designed in different temporal levels to involve users in definition of use spaces in shortly time lapses.

### *Long term adaptability*

Housing layouts, room sizes, and sanitary installations can be refurbished or changed for adapting them to long-term uses. This topic allows to conceive the utility of dynamic emergency dwellings in the different periods that follow the crisis.

### *Customization*

The aspect of customization has a very high incidence in emergency designs for its positive psychological effects. The victims have to resume their lives after crisis, after losing their houses, their goods, their affections. The possibility of customizing their emergency dwelling is a way to make their own home different from each other.

## Safety and comfort

What is wrong in emergency design is its speed and carelessness about the dwellings' quality.

### *Mechanical performances*

The employment of new construction systems and materials that have higher performances and better physical properties, such as lightweight, sustainability, and more, is a crux of innovation and research in this field

of design. This innovation must face the safety of housing spaces, in terms of: performances, from the point of view of intrinsic characteristics; and production cycles, from the point of view of global qualities. E.g., for Italian Civil Protection, the construction materials and technologies, employed in the construction of housing modules, must be:

- uniquely identified by the manufacturer, according to the applicable procedures;
- qualified under the responsibility of the manufacturer, according to the applicable procedures;
- accepted by the Director of contract execution through acquisition and verification of the
- identification and qualification documentation, as well as by possible experimental tests of acceptance.



Figure 77 / The Department of Civil and Environmental Engineering of the University of Western Ontario in London, Canada, carried out an experimentation survey on a full-scale prototype of a shelter of DuraKit Shelters Inc., verifying its resistance even under the heavy loading conditions of tropical winds - ◀ Overall view of test facility, 2003 - © Michael J. D'Costa, F. Michael Bartlett - Journal of Wind Engineering and Industrial Aerodynamics 91 - Elsevier

Figure 78 / ▶ Whiffle tree beam rolling under horizontal jack, 2003 - © Michael J. D'Costa, F. Michael Bartlett - Journal of Wind Engineering and Industrial Aerodynamics 91 - Elsevier

### *Thermophysical performances*

High levels of comfort allow people to concentrate their energies in execution of their tasks. Low levels of comfort reduce human productivity.

### *Fireproofing and waterproofing*

In order to conceive a safety emergency dwelling it is important to consider the design strategies to remove risks for beneficiaries. Major risks are of two natures: fire and water.

### **Reversibility**

Emergency architecture is a form of temporary architecture. The time is variable on the basis of the project and the length of the emergency housing module's phases (from designing to building, from operating to disassembling).

### *Modification of site*

All modifications of construction site must be reversible. We cannot think about emergency housing that needs permanent foundations or plants. The housing modules have to be lightweight and easily connectable to ground.

### *Resetting*

After the operation period, the construction site must be reset to initial state. There must not be any trace of permanence of previous use.

### *Reuse cycle*

After the disassembly, all components of the housing module must be collected and reorganized to be packaged and stored, for being ready for the next operation. This design topic admits, of course, a small percentage of waste material from the disassembly, such as tapes, screws and other fastening accessories.



**Sustainability**

This framework of criteria finishes with the transversal one (it is present in all the others): sustainability. Perhaps, talking about sustainable design is redundant, because each contemporary design must be sustainable. Three topics on sustainability<sup>8</sup> are explained here follow

*Efficiency*

Design strategy of enhancing the capacity of the dwelling of consuming less resources (material or energy) within maintaining high performances.

*Consistency*

Strategy of reducing material flow and reusing material and energy. Cradle to cradle is the vision of an economy modelled on natural material cycles, where resource consumption is reduced to zero by closing the material and energy cycles.



Figure 79/ ◀ Climate zones drawn by Ambrosius A.T. Macrobius in 1492 - The British Library

Figure 80/ ▶ Climate regions drawn by Johannes de Sacrobosco - This map shows the uninhabitable Southern Frigid Zone (at the top, the map has a South-orientation); the unexplored Southern Temperate Zone that is habitable; a Central Hot Zone that is not habitable; the Northern Temperate Zone where Europe, Asia and Africa occupy the known world; and the Northern Frigid Zone that is also uninhabitable - New York Public Library



Figure 81 / Often called “magnetic” or “compass” termite mounds, these nests are aligned in a North-South axis. This bioarchitectural phenomenon is founded in ecophysiological adaptation (2018) - © Dark Orange - via www.flickr.com

*Sufficiency*

This strategy represents a turning point in conceiving building design. *Less is more* becomes *Fair is more*. The household spaces have to be dimensioned due to actual needs, and not to past standards.

**3.5 Bioclimatic design strategies**

*The setting is impartial; it can be kind or cruel, but all living species must either adapt their physiology, through selection or mutation, or find other defences against the impacts of environment.*

Victor Olgyay<sup>9</sup>

Compared to other animals, human capacity of adaptation is weaker. The animals find survival strategies against environment forces, e.g. the termites build blade-shaped nests that point to north. East and west exposition help to secure an equable temperature, and the mass of the earth allows a thermal storage during day-night thermal excursion. The venti-

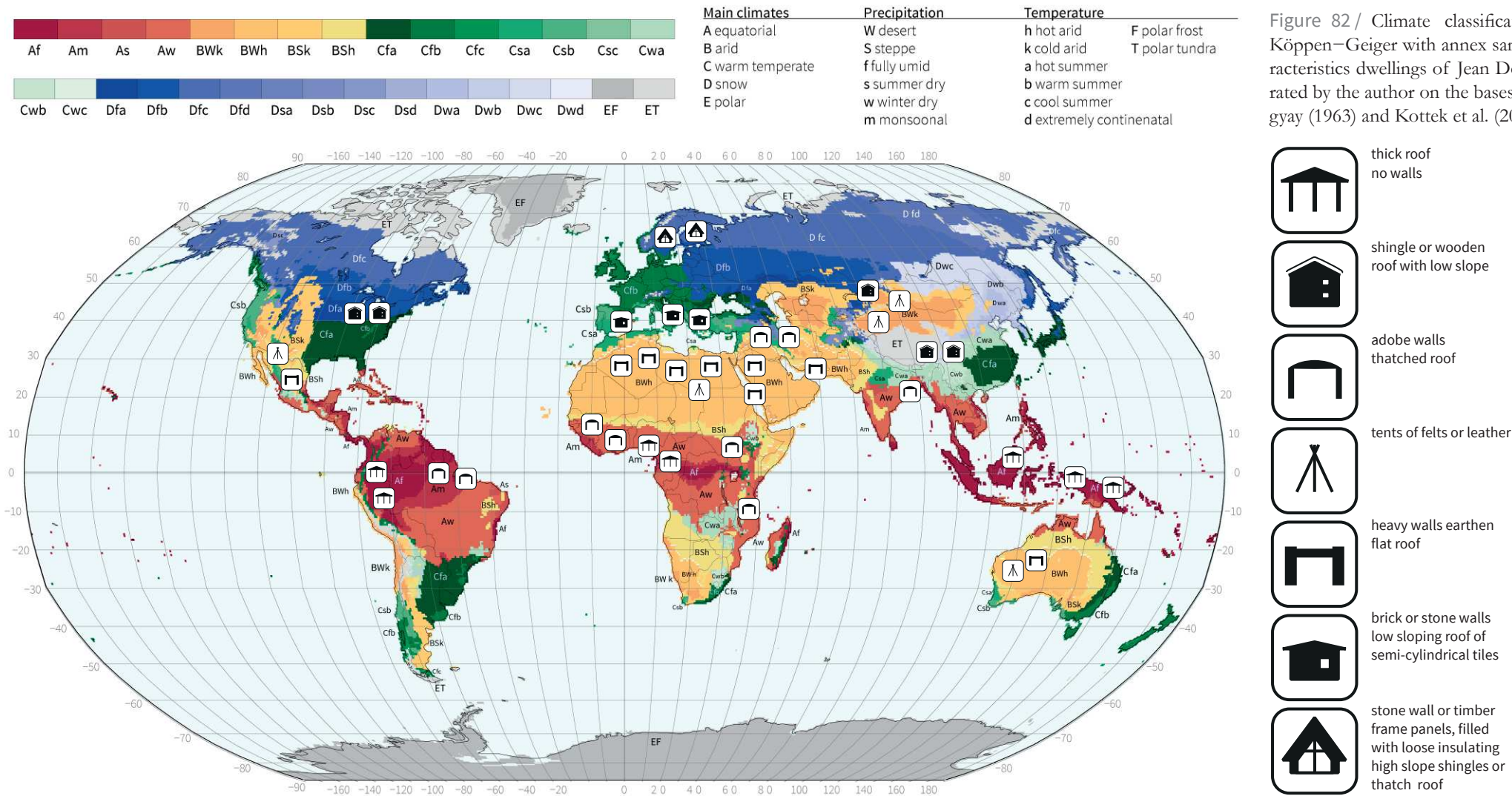

Figure 82/ Climate classification map of Köppen–Geiger with annex sampling of characteristics dwellings of Jean Dollfus - Elaborated by the author on the bases of Victor Olgyay (1963) and Kottek et al. (2006)

lation is guarantee in the daytime through the holes on the envelope. The same holes allow the termites to enter in the nest.

The regional variation of climate conditions in the earth habitable zones is firmly connected with the characteristics of dwelling that insist in the same climate zone. The housing characteristics do not vary with frontiers, but with climate zones, and the general forms of native habitation derive from environment conditions.

As reported by Olgyay in his work *Design with climate*, quoting Dollfus<sup>10</sup>, in the great equatorial forest and tropical savannahs the roof is more essential than the walls, which may be completely deleted (Africa, Australia, Polynesia...). In cold northern forest and mountain regions (Canada, US, Himalaya...), the houses have shingled or wooden roof with low slope for maintaining dry snow as insulation. In intermediate zones (Western Africa, Andes...), the walls are made of adobe and the roof of thatch.

In the same zones, nomads live in tents of felt or leather. In deserts and steppes (Mexico, Gobi...) the earthen roofs are flat, and the walls play the important role of defending against solar radiation. Dollfus divided temperate areas in two zones, the first one characterized by brick or stone walls and low sloping roofs of semi-cylindrical tiles (Mediterranean, China, Southern America...); the second one with stone walls or timber frame panels, filled with mud, rough stone or paper, and roofs made of shingles or thatch with high slope (northern Europe).

Another significant factor underlined by Dollfus is the rate between opaque surfaces and openings, which depends much more on climate conditions rather than psychological factors. For this reason, we can find small openings on thick walls in warm dry zones or in extreme cold zones, to defend the houses against solar heat inputs, or to avoid heat dispersion from inside. In the northern of Europe, the size of openings are proportioned to maximize sun heat and light.

Olgay defined “climate balanced” a structure that reduces undesirable stress in a given environment by working with forces of nature and not against them. A perfect balanced house is hard to achieve, but it is always possible to find a good compromise between natural resources and consumptions.

High-tech solutions often act at the end of the designing process and against natural settings: where there are small openings, it would be placed good lighting systems; where there is not good insulation, it would be provided a good heating system. It is easier and cheaper to think backward at passive strategies useful to reduce technology needs, e.g. planning lots of openings in working zones, or improving the insulation of walls and roofs. Good insulation and good ventilation are both cheaper than an HVAC system.

Low-tech strategies are passive measures deducted from the natural environment and in harmony with it. Using onsite environmental energies is free and reliable in the long term, while technical systems could malfunction<sup>11</sup>.

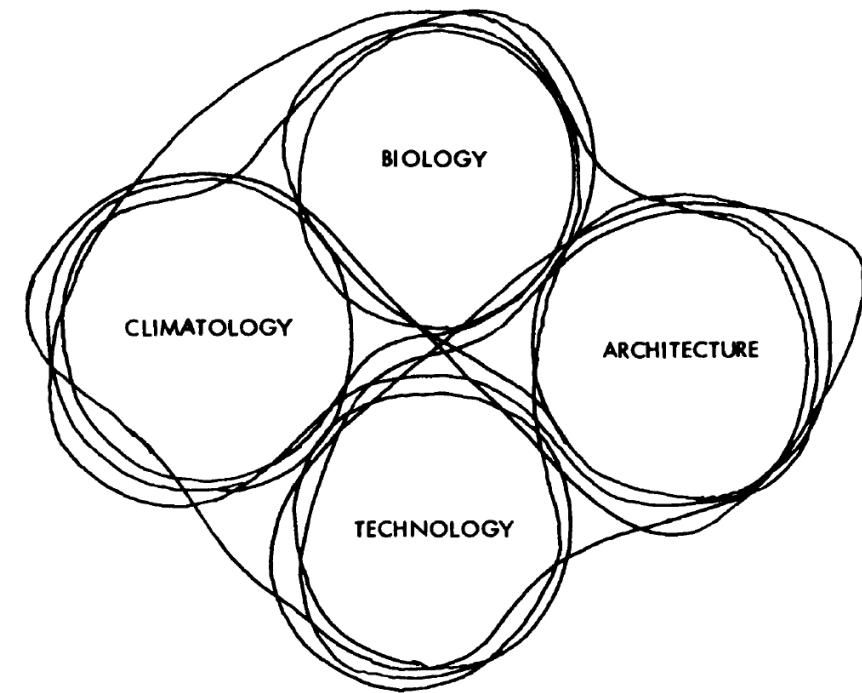

Figure 83 / A diagram in the book shows four interlocking circles: biology, climatology, technology, and architecture. The lines of the circles are soft multi-layered lines, emblematic of the riparian merging of these disciplines. Bioclimatic design takes these disciplines and considers them together - Victor Olgay

Clearly, it is impossible to say that only the low-tech solutions can guarantee suitable comfort conditions, but they should be the first design strategies. What is not achievable by low-tech solutions, it is possible to be got with technical systems. This is also supported by life-cycle assessment: technical systems have a shorter life-cycle than building factory.

*Bioclimatic design uses nature's energies to harmonize buildings with local conditions. The physics of the environment, such as solar radiation and the convection of wind are employed as formal influences to create a climate balanced design.*

Victor W. Olgay<sup>12</sup>

How can the objective of bioclimatic design be achieved through low-tech solutions?

How can architecture match with biologic, climatic and technologic issues in a quality project?

Victor Olgyay himself answered to these questions

People are the fundamental measure in architecture and their biological needs have to be fulfilled by the designed shelter. What follows is the evaluation of the impact with climate, in physiological terms., The climate-comfort problem is solved (during the last step of the process) through technological solutions.

### 3.6 Design indexes

According to the *Bootcamp Bootleg*<sup>13</sup> of the Institute of Design at Stanford (d.school), the design principles are strategies to solve a design challenge independent of a specific solution. The designer articulates these principles translating his findings, such as needs and insights, into design directives. These principles give a format to capture abstracted, but actionable, guidelines for solutions, and communicate design intentions to others.

The approach of looking at the best practice of tiny house production, both residential and emergency ones, permits to identify several qualitative elements and their relative best applications.

E.g. the on-site operations are often the cause of delay in construction process, which in emergency means low availability of housing solution in short time. Ikea answers to this issue by providing the Better Shelter, which is mountable in 1 day by the same users.

Paper Log house with a cost of about 120€/m<sup>2</sup> is the cheaper emergency housing module for to its construction materials (paper tube, fruit and beer boxes, fabrics,...) and the engagement of locals.

Each addressed case study highlights one or more characteristics of extreme quality compared to the others. Thanks to these evidences, it was

possible to build a table defining for each characteristic 5 quality levels formulated on the basis of the best practices analysed.

Thus, this table presents a list of indexes corresponding to qualitative values, each one defined by 5 levels.

The scope of the design process is to maximize the rating of the solution, which may be not the best for the single index but the most effective overall.

Description	index				
	1 (low)	2	3	4	5 (high)
<b>Transportability</b>					
Transportation quantity	1 house/4 containers	1 house/3 containers	1 house/2 containers	1 house/1 container	2+ house/1 container
Packaging size	Complete house	Pre-assembly house	House-kit No pallet	House-kit Large pallet	House-kit Small pallet
Handling	Totally by heavy vehicles	Partially by heavy vehicles	Lift elevator	Manually and lift elevator	Manually
<b>Assembly</b>					
Self-construction skills	Advanced operator	Specialized operator	Self-construction with technical supervisor	Self-construction with safety supervisor	Self-construction
Tools	Professional heavy tools	Heavy tools	Professional power tools	Power tools	Light tools
Easiness of the assembly manual	Hard wet operations	Few dry operations/hard wet operations	Dry operations/few wet operations	Detailed Dry operations	Easy dry operations
<b>Availability</b>					
Supply distance in km	+5000	1000-5000	500-1000	100-500	0-100
Supply rapidity	+ 1 month	1 month	2 weeks	1 week	1 day
Storage: N° houses/1000m <sup>2</sup> warehouse	1-5	5-20	20-50	50-100	100+

Table 8 / Design index, follows in next page

Description	index				
	1(low)	2	3	4	5 (high)
<b>Flexibility</b>					
Short term adaptability layout, furniture	No variabilities	Low variability of furniture	Variability of furniture	Low variability	High variability
Long term adaptability shape, extension, technical system	No variability	Low variability of technical systems	Variability of technical systems	Low variability	High variability
Customization finishings, systems, accessories	No customization	Internal finishing	External and internal finishings	External and internal finishings, systems, accessories	Totally
<b>Safety and comfort</b>					
Mechanical performances compliance	Local compliance	Regional compliance	National compliance	Continental compliance	Worldwide compliance
Comfort and thermophysical performances	Comfort rate 30%-	Comfort rate 30-5%	Comfort rate 50-70%	Comfort rate 70-90%	Comfort rate 90%+
Fireproofing and waterproofing compliance	Local compliance	Regional compliance	National compliance	Continental compliance	Worldwide compliance
<b>Reversibility</b>					
Modification of site	Totally irreversible	Partially irreversible	Partially reversible	Temporary	None
Resetting	None	Very few	few	Partial	Total
Reuse cycle	None	Very few	few	Partial	Total
<b>Sustainability</b>					
Energy demand (efficiency)	High energy demand	Low energy demand	No energy demand	Plus Energy production	Autarchic Off-grid
Reuse quantity (consistency)	No recycled/ no recyclable materials	No recycled/ partially recyclable materials	Partially recycled/ partially recyclable materials	Partially recycled/ recyclable materials	Totally recycled/ recyclable materials
Occupancy duration (sufficiency)	More than 10 years	8-10 years	5-8 years	3-5 years	1-2 years

## Footnotes chapter 3

- 1 Fraser T. M. (1969), p. 15
- 2 Foti M. (1977)
- 3 Soen D. (1979), p. 129
- 4 Conrads U. (1964), p. 157
- 5 Presidency of the Council of Ministers - Department of Civil Protection
- 6 McDonough W. and Braungart M. (2012), p. 33
- 7 Drexler H. El Khouli S. (2012), p. 68-69
- 8 McDonough W. and Braungart M. (2012), p. 42
- 9 Olgyay V. (1963), p. 1
- 10 Ibidem, p. 6-7
- 11 McDonough W. and Braungart M. (2012), p. 41
- 12 Olgyay V. W. (2015), Q&A interview Princeton University Press
- 13 d.school, p. 25

## 4/ cardboard architecture

The aim of developing a feasible emergency house-kit is achieved by a joint venture between academic research and industrial production. This chapter describes the adopted patented construction system made up of cardboard and the preliminary tests conducted for its thermophysical characterization.



## 4.1 The roots of the research

The Department of Civil Engineer and Architecture (DICAR) of the University of Catania and the company Area srl had established a research framework with the scope of characterize a new low-cost and low environmental impact building solution that ensure structural strength and thermal-acoustic comfort, which is not energy consumer neither during production process and management, nor during disposal.

*Archicart Cardboard Architecture* is a brand of the company Area srl, which aims to provide prefabricated, lightweight and easy-assembling components for architecture, furnishing and constructions made up of corrugated cardboard.

Archicart takes up the challenge of new building solutions, by cutting down environmental and economic costs and enabling forms of self-construction, in answer to the earth transformations due to social tensions.

Archicart's building system establishes a renewed housing dignity for emergency architecture, because it ensures high levels of comfort and

long lasting components, even respecting the time of installation, low cost and temporary uses. Archicart system efficiently and effectively uses corrugated cardboard: it employs production processes of papermaking industry; and it carries out structural elements that are easy-assembling, highly resistant, and thermos-acoustical insulated. This system, thanks to its intrinsic features, satisfies the following needs:

- good mechanical and thermal-sound performances,
- fire- and waterproofing,
- lightweight,
- easy to manipulate,
- low-impact on the environment,
- total recycling and good biodegradability,
- easy availability,
- low-cost,
- easy construction operation,
- versatile employ,
- high number of reusing cycles,
- opportunity to carry out production cycle.

## 4.2 Corrugated cardboard

Corrugated cardboard is an industrial product made up of cellulose fibre, composed by overlapping layers of tensed paper sheets and layers of corrugated ones.

The invention of corrugated cardboard, as we know it today, dates back to 1875 by the work of J. H. Thompson. He had the intuition of gluing corrugated paper (a layer of tensed paper and a layer of corrugated one, already existing), with a second layer of tensed paper. The final structure presents a double layer of tensed paper, separated by a layer of corrugated paper, glued firmly together. Thanks to this structure, the stiffness of the simple corrugated paper improves, as well as the resistance and the usability in other transportation fields like packaging. This type

of corrugated cardboard is called *single wall*. To obtain a more resistant structure, maintaining the plan of external surfaces, it is possible to insert a second corrugated layer and another tensed intermediate layer. This type of cardboard is called *double wall*.

Single and double cardboard walls are the most common, and are used for packaging, protection and transport of objects. Even more complex is the structure of *triple wall* cardboard that presents, between the double layer of tensed paper, three layers of corrugated papers and two of tensed intermediate ones. Its spread is currently limited (about 3-4% of the entire Italian production of corrugated cardboard), and its use is specific, e.g. manufacture of transport boxes, instead of using wood, or for containers

Figure 84 / Detail of a double-wall corrugated cardboard profile, 2007 - Verband der Wellpappen-Industrie e.V.

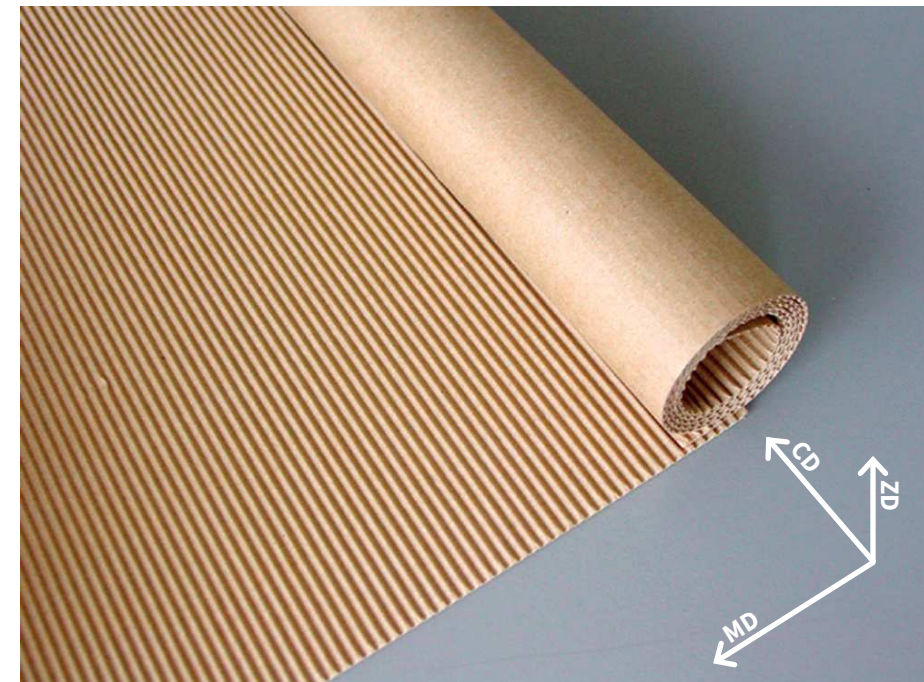
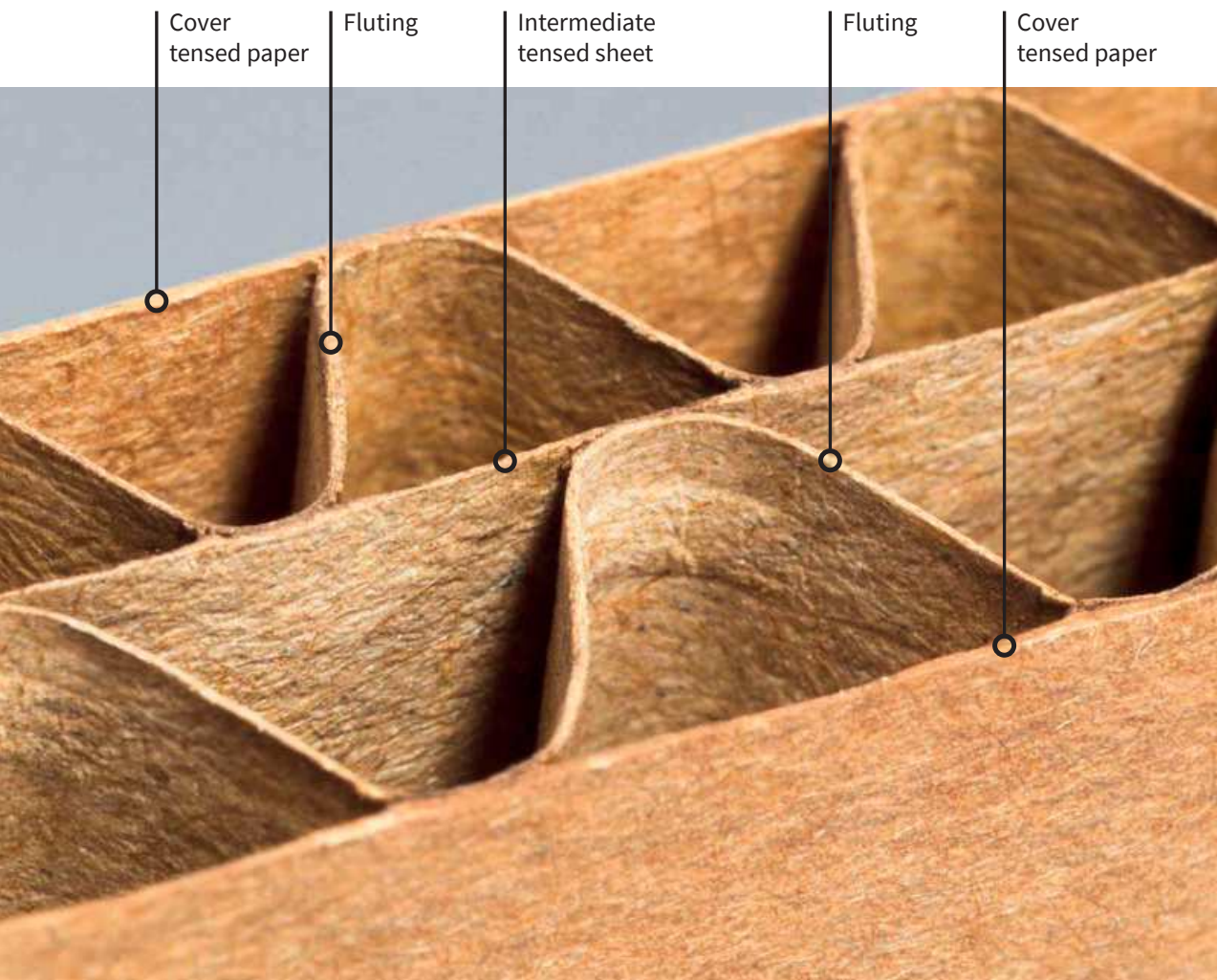

Figure 85 / Detail of corrugated paper with indication of normalized directions: Cross Direction (CD), Machine Direction (MD) and Z Direction (ZD)

filled by liquids contained in plastic bags.

The papers employed for the production of corrugated cardboard are of different nature like different are the functions of each layer of paper in the structure of a corrugated cardboard.

The papers used for surfaces are defined covers, that are inside an external cover and an internal cover, in relation with the orientation of the cardboard in the assembled box.

The corrugated papers, that outdistance the covers, are called flutings or waves. The flat intermediate papers, that separate each fluting from the other, are called tensed sheets.

### Paper covers

They constitute the external layer of the corrugated cardboard panel and have the scope of resisting to axial loads in cross direction (CD) and



to compression loads in normal direction (ZD).

Paper covers are exposed to the environment and have to guarantee the durability of the entire corrugated cardboard panel, against to air and moisture.

### Tensed sheets

They constitute the intermediate elements that connect two adjacent flutings and they contribute to the thickness of the final product. Tensed sheets are made up of papers with high porosity to guarantee a good penetration of the necessary quantity of glue, useful to join the flutings.

Furthermore, the papers for tensed sheets are loaded by tensile load due to the tendency of single wave of resetting horizontally the fluting, that distances two adjacent peaks.

### Flutings

They are papers corrugated by specific machineries with the scope of maintaining the correct distance between tensed sheets, during the life cycle of a corrugated cardboard. This distance has the characteristic of increasing the inertia of the section and its bending stiffness. Moreover, the flutings play the role of ribs: increasing the CD compression resistance.

#### □ Type of paper employed for tense cover layers and tensed internal ones:

- **K** - brown Kraftliner
- **Kw** - white Kraftliner
- **L** - brown Liner
- **Lw** - white Liner
- **T** - brown Testliner
- **Tw** - white Testliner
- **C** - Chamois
- **Cw** - white Chamois

#### □ Type of paper employed for fluting:

- **SS** - Scandinavian Semi-chemical
- **S** - Semi-chemical
- **US** - Use Semi-chemical - Wellenstoff
- **M** - Medium
- **F** - Fluting

#### □ Type of flute shape (parameters that characterize the fluting):

- height: is the distance in millimetres between the crest and the base of the wave;
- step: is the distance in millimetres between the two adjacent ridges of a wave;
- number: it is the quantity of waves contained in a linear meter;
- corrugation coefficient: is the ratio between the length of the paper, used for fluting, and the final length of the corrugated paper. It indicates the paper consumption in relation to the corrugation.

class [n°]	weight [g/m <sup>2</sup> ]
2	125
3	150
4	175
5	200
6	225
8	275
9	300
02	337
04	400
06	440

Table 9/ Identification classes per weights of cover papers - 2007 Negri

class [n°]	weight [g/m <sup>2</sup> ]
2	112
4	127
6	150
9	180

Table 10/ Identification classes per weights of internal tense papers - 2007 Negri

class [n°]	weight [g/m <sup>2</sup> ]
2	120
4	145
6	170
9	210

Table 11/ Identification classes per weights of fluting papers - 2007 Negri

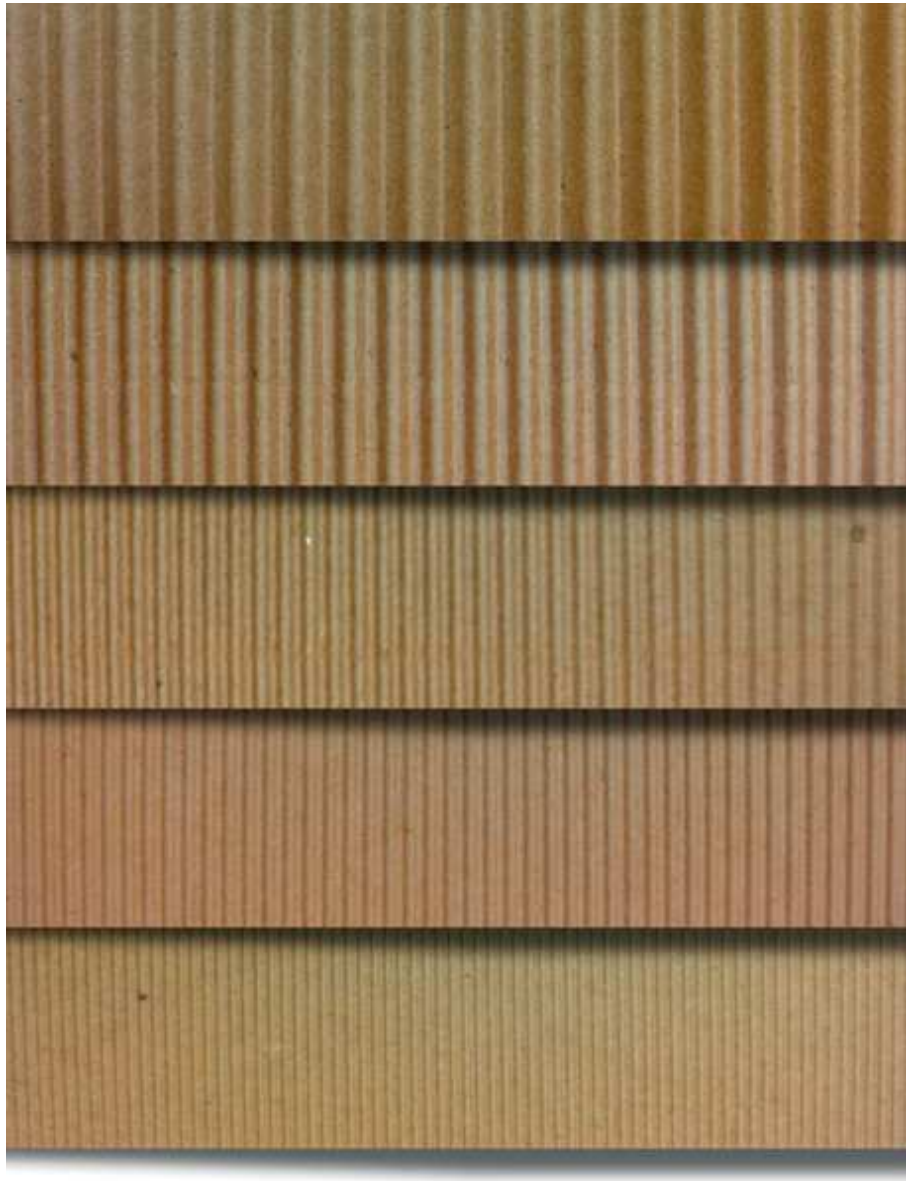

Figure 86 / Type of flutes, in evidence the different number of waves per meter - corrugated-sheets.com

Type	Height [mm]	Step [mm]	Number [n°]	Corrug. coefficient	Characteristic
K	>5	14,9	67	-	used to make heavy double wave and triple wave cardboard
A	>4,5	8,6÷9,1	110÷116	1,48÷1,52	it gives to the panel high vertical compression resistance and greater moment of inertia of the section; low resistance to in plane compression (burst) and low printability due to the distance of the waves
C	3,5÷4,4	7,3÷8,1	123÷137	1,33÷1,36	it represents an excellent compromise between paper consumption and performances; good printability and high vertical and in plane compression resistances
B	2,5÷3,4	6,3÷6,6	152÷159	1,23÷1,30	good printability and good resistance to in plane compression; the vertical compression resistance is low due to the thickness
E	1,2÷2,4	3,2÷3,4	294÷313	≈1,27	used as cushioning, it guarantees high printability properties
F	0,7÷0,9	2,3÷2,4	417÷435	≈1,19	fluting recently introduced for the new packaging sector
G	0,5÷0,6	1,8÷1,9	526÷556	-	-

Table 12 / Types and characteristics of waves for corrugated cardboard - 2007 Negri

### 4.3 Archicart technology

Archicart<sup>1</sup> technology is useful to provide emergency housing solutions in assembling kits, with completely customizable plants. The strong point of this system is the effectiveness of the modular design required by current emergency architecture, which needs versatility in use and continuous adaptability to housing conditions.

The basic construction elements are alveolar panels made up of corrugated cardboard (PACO). These alveolar structural panels are easy to transport and to joint mutually everywhere and in short time, and they can be employed for building both full equipped housing module or external and partition walls for other building structures.

Archicart PACO is a groundbreaking patented technology. The panels are characterized by many coaxial layers of corrugated cardboard sheets glued firmly together. The construction method involves the dry assembly

of rigid septa of corrugated cardboard to realize load-bearing walls, roofs, floors, partitions and other constituent parts of the building.

The septa are made of alveolar panels of corrugated cardboard (PACO) supplied in different size and totally customizable finishes.

The concept of the panel includes elongated box-shaped elements with a rectangular cross section made of corrugated cardboard, in the jargon *bands*, open at opposite ends. These bands are disposed coaxially with an external section that contains some intermediate bands, which in turn contain some internal ones, fixed together by glue and bands. At upper

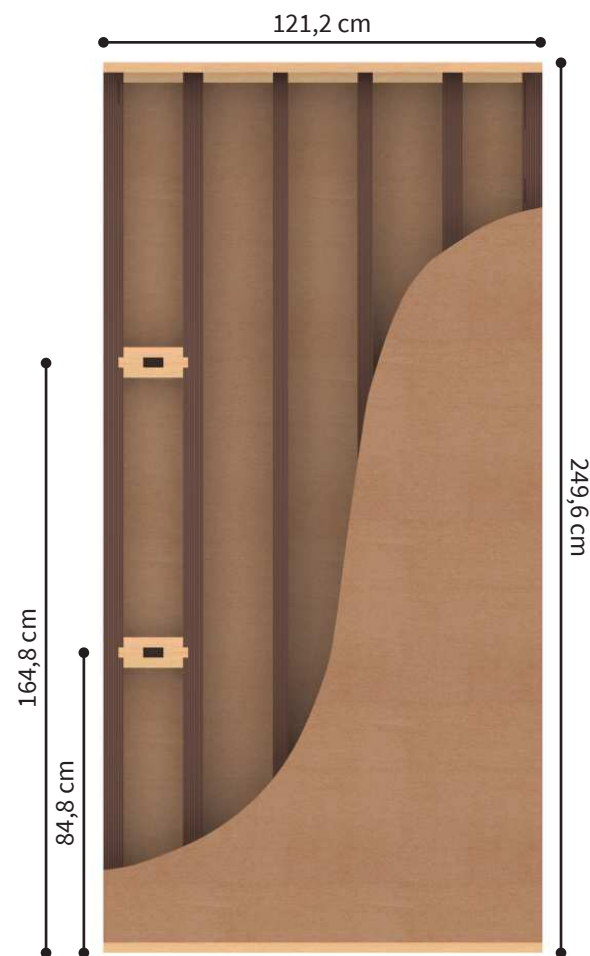

Figure 87 / Cross section of Archicart PACO120 - © Archicart patent

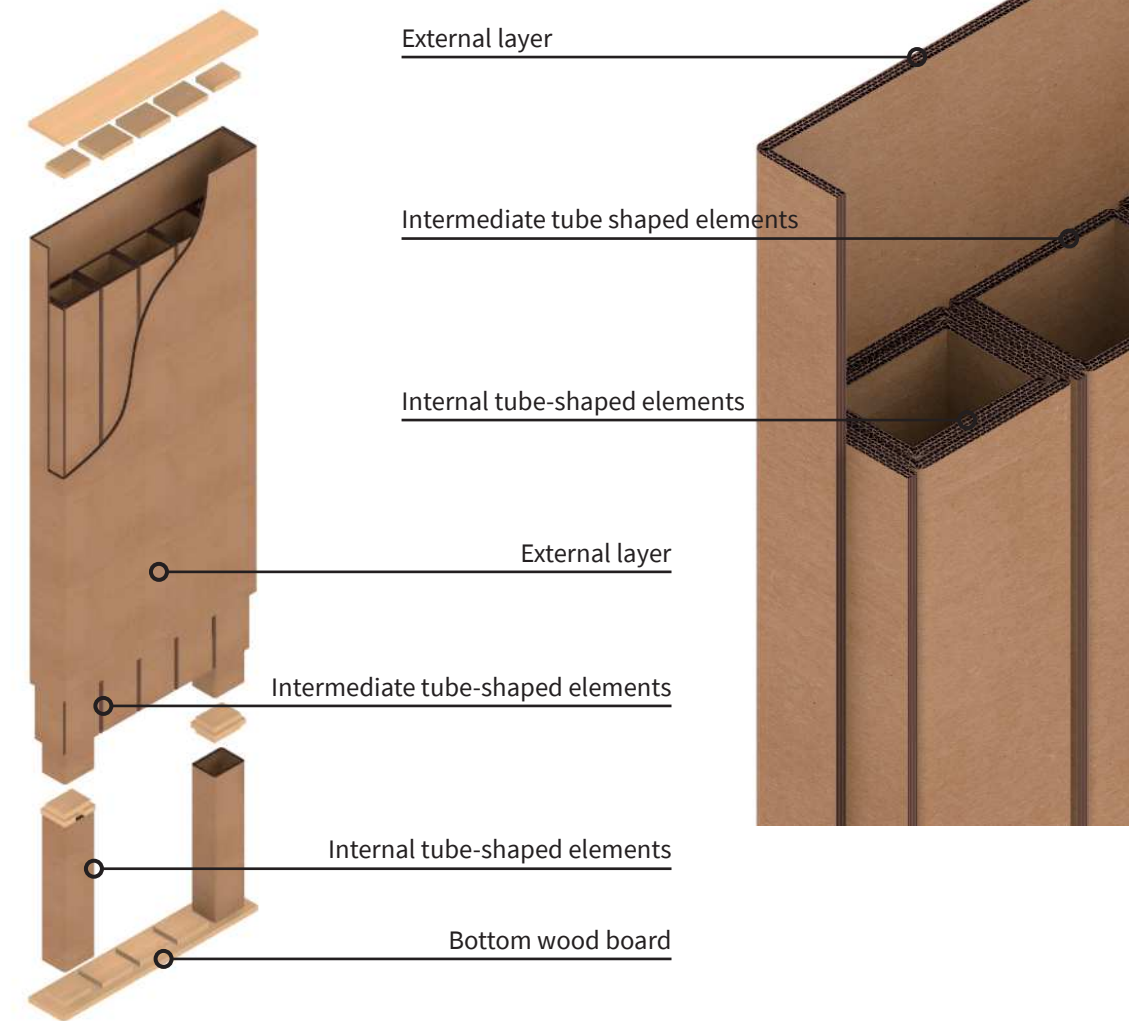

Figure 88 / Axonometric cross section of Archicart PACO120 - © Archicart patent

and lower ends the panel is closed by two wooden boards, equipped with joints, that fit within the corrugated cardboard box elements. Inside internal box-shaped elements there are wooden elements used to stiffen the panel and to hold the metal accessories, necessary for the mutual assembly of some PACO to realize complete building structures.

The characterization of the PACO finish is obtained by using air- and waterproofing sheaths and by fixing a wooden external stiffening frame with a finishing layer in any type of material, such as plasterboard, honeycomb, polycarbonate, plywood, particleboard, metal, even plastic fabric.

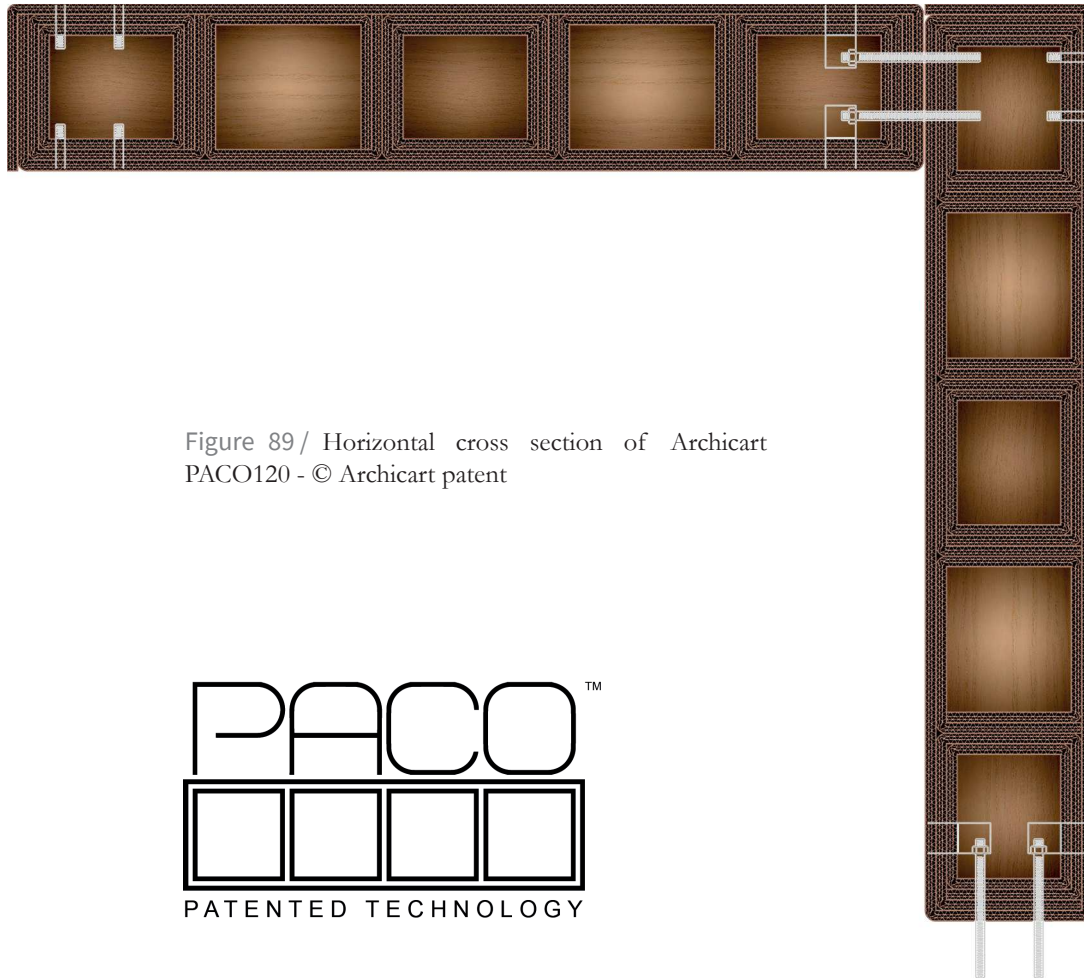

Figure 89 / Horizontal cross section of Archicart PACO120 - © Archicart patent



## 4.4 Heat flow meters measurements

One of the preliminary analysis of this research is to determine the thermal conductivity, U-value, of Archicart PACO when a different type of thermal insulation is placed within the air cavity. This result allows to characterize the thermal performance of the panels and their satisfaction of specific requirements.

As well known, thermal conductivity k-value, expressed in  $W/m\cdot K$ , is a measure of the effectiveness of a material to transfer thermal energy.

Measurements of k-value were carried out through the Heat Flow Meters NETZSCH HFM 436 Lambda, which is a calibrated instrument that performs tests according to ASTM C518, ISO 8301, JIS A1412, DIN EN 12664 and DIN EN 12667. The HFM was placed in a conditioned laboratory at a temperature of  $23 \pm 2$  °C and relative humidity of  $50 \pm 5\%$ , according to the test conditions required by the standard EN 12664:2002.

Figure 90 / Operating scheme of NETZSCH HFM 436 Lambda - © Dario Distefan

Metallic accessories (fastened inside the inner layer of boxing elements, equipped with wooden joints) secure PACOs both together and to the base and roofing.

This construction method offers a high functional dynamism: it is, indeed, based on dry system, and on an ever-changing design approach that, starting from a basic housing module, could become a more complex building, in regard to users' needs, with the passing of time. The spatial shape reproduces, on a larger scale, the same operating principle of boxes that is adopted for the panel-packaging. Panels are installed (through threaded bars), either in series or in progression, to create linear and corner walls. This system has the advantage of the modular dimension that enables to adapt forms to real needs of housing solutions.

A heat flux sensor is a thermopile sensor, consisting of thermocouple junctions uniformly arranged across the sensor surface. Each individual junction generates an electrical voltage, proportional to the difference in temperature across the hot and cold junctions of the thermocouple.

Thermoelectric Peltier elements are used to heat and cool the HFM testing plates. The HFM operates as follows: a sample is positioned between two heating/cooling plates. The upper plate is powered to contact the top of the sample.

One heat flux sensor is integrated into each plate and is used to monitor heat flux ( $Q/A$ ) generated by the difference in temperature ( $\Delta T$ ) between the top and the bottom plate, at regular intervals, until steady-state heat flux is observed. The composite heat flux is then used to calculate thermal conductivity ( $\lambda$ ) and thermal resistance ( $R$ ) according to Fourier's Law.

### Thermal conductivity of PACO with different fillings

The thermal conductivity of the PACO has been determined with the internal cavity filled with three different thermal insulating materials, as well as only air. Thus the follows filling material were considered:

- Air
- EPS ( $k= 0,041 \text{ W/m}\cdot\text{K}$ )
- Expanded clay ( $k= 0,059 \text{ W/m}\cdot\text{K}$ )
- Cellulose fibre ( $k= 0,050 \text{ W/m}\cdot\text{K}$ )

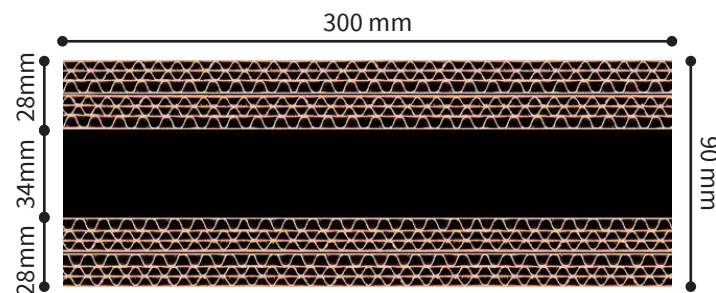

Figure 91 / Archicart PACO specimen

	External layers	EPS filling	Clay filling	Cellulose filling
Size [mm]	300×300	300×300	300×300	300×300
Thickness [mm]	28+28	34	34	34
Density [kg/m <sup>3</sup> ]	110	10	400	141
Weight [kg]	0,28+0,28	0,03	1,22	0,43
Percentage of weight [%]	-	5,08	68,54	43,43

Table 13 / Features of the PACO specimens

As the NETZSCH HFM 436 Lambda is able to accept specimens of a maximum dimension of  $300 \times 300$  mm and 10 mm thick, the PACO samples have got dimensions of  $300 \times 300 \times 90$  mm height. Table 13 shows the features of the samples with the different thermal insulation used in the test.

The tests were conducted varying the mean temperatures of the sample (15 and 25 °C), and imposing a constant  $\Delta T$  of 20 °C between the plates. Thereby, the operating conditions were: 5 - 25 °C and 15 °- 35 °C.

### Measurements results

Thermal conductivity was measured 5 times for each sample. No significant differences were found among each measuring specimens. Once the coefficients of thermal conductivity  $k$  of the samples had been measured, the thermal resistance of the panels has been calculated as  $R_{p90,j} = s / k$ .

Starting from this result, the thermal resistance of the PACO 120/22, that has a thickness of air gap  $s = 164$  mm filled with 16,4 cm of thermal insulation, has been calculated<sup>2</sup>.

The total resistance is calculated by summing to the  $R_{p90,j}$  value the thermal resistance provided by the further 130 mm of thermal insulation  $\Delta R_{isol,j}$

$$R_{p220,j} = R_{sp,j} + \Delta R_{isol,j} \quad (1)$$

The  $R$ -value of the bare PACO system, calculated by subtracting the  $R$ -value of the thermal insulation panels, were perfectly convergent, con-

firming the repeatability of the measurements carried out. Lastly, the total resistance of the PACO 120/22 has been calculated as:

$$R_{T220,j} = R_{se} + R_{P220,j} + R_{si} \quad (2)$$

The values of  $R_{se}$  and  $R_{si}$  are posed respectively equal to 0,04 and 0,13  $m^2 \cdot K/W$ .

	Air	EPS	Clay	Cellulose Fibre
Specimen Rsp,j	1,125	2,179	1,515	1,797
$\Delta R_{isol,j}$	---	3,147	2,188	2,596
$R_{P120,j}$	1,125	5,326	3,703	4,393
$RT_{120,j}$	1,295	5,496	3,873	4,563
$UT_{120,j}$	0,77	0,18	0,26	0,22

Table 14 / Features of the PACO 120/22

### Thermal conductivity of PACO with different treatments

The thermal conductivity of the PACO has been determined with the internal cavity filled with cellulose fibre and three different coating treatments:

- SP.00\_N/N - no filling + no treatment ( $k = 0,083 \text{ W/m}\cdot\text{K}$ )
- SP.01\_N/CL - cellulose fibre + no treatment ( $k = 0,053 \text{ W/m}\cdot\text{K}$ )
- SP.02\_W/CL - cellulose fibre + waterproof wax ( $k = 0,064 \text{ W/m}\cdot\text{K}$ )
- SP.03\_SO\_CL - cellulose fibre + silicon oxide ( $k = 0,065 \text{ W/m}\cdot\text{K}$ )



Figure 92 / Archicart PACO specimen

	SP.00_N/N	SP.01_N/CL	SP.02_W/CL	SP.03_SO/CL
Size [mm]	300×300	300×300	300×300	300×300
Thickness [mm]	28+32+28	28+33+28	28+34+28	28+33+28
Density [kg/m <sup>3</sup> ]	-	29,96	29,56	30,41
Weight [kg]	0,29+0,29	0,29+0,075+0,29	0,29+0,075+0,29	0,29+0,075+0,29
Percentage of weight [%]	-	10,95	10,87	10,95

Table 15 / Features of the PACO specimens

Table 15 shows the features of the samples with the same thermal insulation, but different coating treatments used in the test.

The tests were conducted varying the mean temperatures of the sample (30 and 40 °C), and imposing a constant  $\Delta T$  of 10 °C between the plates. Thereby, the operating conditions were 25 - 35 °C and 35 ° - 45 °C.

### Measurements results

Thermal conductivity was measured 5 times for each sample with no significant differences among each measurement. Once again, the coefficients of thermal conductivity  $k$  of the samples were measured, the thermal resistance of the panels has been calculated as  $R_{p90,j} = s / k$ . Thus, the thermal resistance of the PACO 120/22, that has a thickness of air gap  $s = 164 \text{ mm}$  filled with 16,4 cm of thermal insulation, has been calculated.

The total resistance is calculated by summing to the  $R_{p90,j}$  value the thermal resistance provided by the further 132 mm of thermal insulation  $\Delta R_{isol,j}$  with (1) and lastly the total resistance of the PACO 120/22 has been calculated with (2) and with  $R_{se}$  and  $R_{si}$  respectively equal to 0,04 and 0,13  $m^2 \cdot K/W$ .

	SP.00_N/N	SP.01_N/CL	SP.02_W/CL	SP.03_SO/CL
Specimen Rsp,j	1,59	2,47	2,03	2,02
$\Delta R_{isol,j}$	---	2,16	2,16	2,16
$R_{P220,j}$	1,80	4,59	4,45	4,94
$RT_{220,j}$	1,98	4,76	4,62	5,11
$UT_{220,j}$	0,50	0,210	0,216	0,196

Table 16 / Features of the PACO 120/22

Footnotes chapter 4

- 1 Distefano D. Sapienza V. (2014), patent No. EP 2.927.385 A1, Area srl Catania
- 2 Distefano D. et al. (2018)

## 5/ cardboard house-kit

This chapter is the core of the research. It deals with the design moment of the research when all the strategic choices have to be made on the basis of the results of the precedent chapters and in accord with the results of parametric simulations. An actual executive design of the emergency cardboard housing module is the main output of chapter 5.



## 5.1 Design process

Designing a cardboard emergency housing module, that could be employed after several crisis events, represents a challenge, because there is not the possibility to foresee the users' socio-cultural factors and the features of the sites. For this reason, the object of the design process cannot be a singular project, but a program of adaptive design strategies that fit with different operative conditions.

The design process is planned as follows:

1. individuation of tools
  - socio-cultural principles
  - emergency design strategies
  - bioclimatic design strategies
2. architectural design
  - modular design
  - architectural design
  - technical proposal
3. parametric design
  - modelling of architectural concept
  - individuation of variable parameters
  - simulation and proof of concept
  - re-design
4. executive design
  - definition of technology's details
  - component description
  - executive design.

## 5.2 Tools

### Socio-cultural principles

The UNHCR's Global Shelter and Settlement Strategy<sup>1</sup> defines a list of guiding principles to satisfy displaced shelter and settlement needs and

to meet people's basic needs and improve their quality of life, wherever they live in urban or rural settings.

### *Human rights*

The right to adequate housing was first recognized by the Article n. 25 of the Universal Declaration of Human Rights. The principle "Everyone has the right to adequate housing" is valid for all the phases of the displacement cycle (before, during and after the displacement), and it is universal. Adequacy of housing includes: security of possession; availability of services, materials, facilities and infrastructures; affordability; habitability; accessibility; location; and cultural adequacy.

### *Age, Gender and Diversity*

Policy and programs must respect the diversity of the communities, their gender equality and their access to rights, without considering their age and cultural, religious and educational background. Particular attention must be paid to those who have suffered for exclusion and lack of rights (women, children, the elderly, people with disabilities and minority groups).

### *Participation*

Refugees, displaced people and affected population should be allowed to participate in programme planning, needs assessment, implementation, monitoring and evaluation in order to plan suitable, appropriate, sustainable and culturally sensitive programmes. In addition, they should be involved, as much as possible, in the design, construction, and maintenance of shelters, settlements, and CRI support. Particular emphasis should be made to engage with groups that may have specific protection concerns and needs, including women, the elderly, people affected by disabilities, sick people, and children, who typically have less access to decision making mechanisms and who also spend the most time in shelters. This participatory process should be introduced in the developing shelter and

settlement policy so that, the needs, requirements and diverse profiles of people of concerns will be taken into consideration, within the framework of international standards and human rights.

### *Sustainability*

Policies and programmes should be improved and implemented with sustainability and durable solutions as the final goal. Several issues must be considered, including appropriate technology, capacity building of both people of concern and local communities, and use of local skills, materials, techniques and know-how.

### *Environmental Considerations*

Shelter and settlement interventions need to be planned and implemented to lessen, to the extent possible, the impact on the natural environment and to prevent hazard risks, including landslides, floods, earthquakes etc. Attention must be given to laws and regulations governing the use of environmental impact assessments, before designing and planning the shelter and settlement programme.

### **Emergency design strategies**

The design process is showed in the table 8 of design index presented in chapter 3.

The table is an effective tool that allows to conceive a repeatable model of emergency house-kit, by comparing its features with the ones of current systems.

### **Bioclimatic design strategies**

At the base of these strategies there is the knowledge of the site operative conditions to intercept the adverse impacts and use the advantageous ones<sup>2</sup>.

Although it is difficult to conceive an emergency shelter without considering the emergency site, it is possible to deal with climate, by fixing

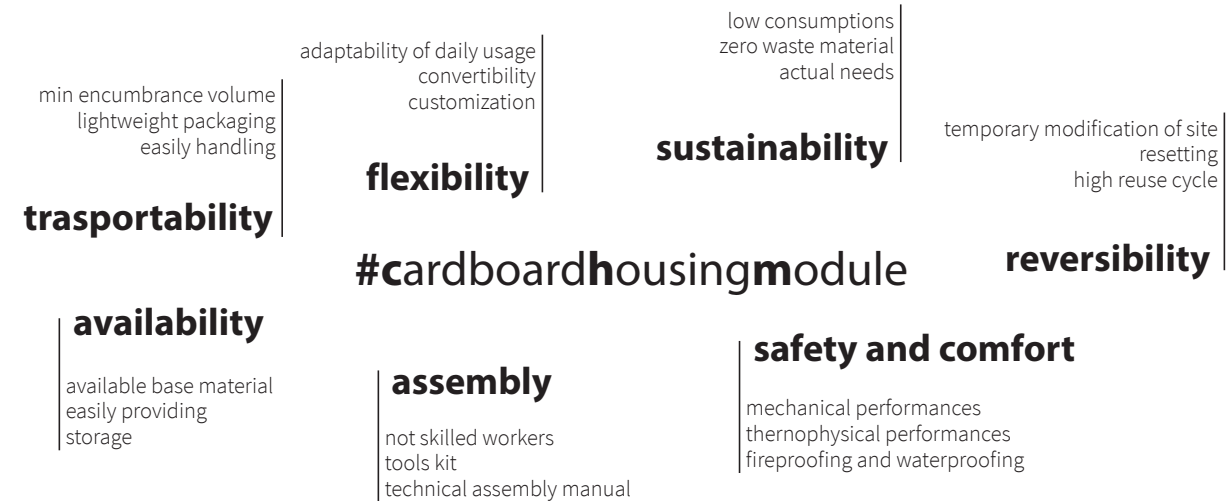

Figure 93 / Emergency design strategies

several strategies and improving the applicability of the designed solution in several operative conditions.

### *Site selection*

Many factors are variable, but there are some features for better exposition conditions for a settlement:

- natural shading by trees
- distance from urban overheating
- proximity to watercourse.

### *Orientation*

The perfect balance of solar radiation between cold periods and hot ones respectively derives from the maximization of solar gains and the minimization of overheating.

*Shading devices*

The regulation of solar heating is achievable through dynamic shading systems calibrated on the sun path. Their form can change in seasons, or may be designed to let sunbeams pass in winter and block in summer.

*Shelter forms*

There are several building shapes that allow different environmental performances: elongated or stubby, developed in length or developed in height, court-shaped or L-shaped.

*Air movements*

They can be divided into winds and breeze. The first ones should be intercepted in under-heated periods. The second one should be used during overheated periods. Natural indoor ventilation should be allowed to satisfy bioclimatic needs.

*Indoor temperature balance*

The correct balance between time-lag and insulation characteristics of building materials should be defined for achieving a certain temperature degree. The criteria for balance are: minimum heat-loss in cold periods, and minimum heat-gain in hot periods.

**Thermal comfort equation**

It is defined by ASHRAE 55-2004<sup>3</sup> and by ISO 7730 as that condition of mind which expresses satisfaction with the thermal environment and is assessed by subjective evaluation.

The first discussion on thermal comfort was carried out by P.O. Fanger<sup>4</sup>, which obtained the expressions from theoretical considerations and through a large number of experimental tests on different people (for sex, age, clothing, different activity, in air-conditioned environments) at different environmental conditions (temperature, humidity, average radiant

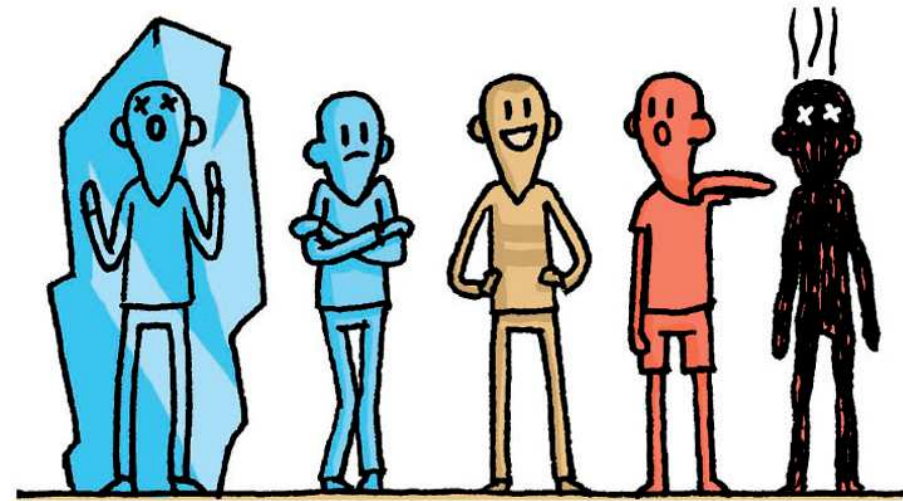

Figure 94 / The human body is like a heat engine that produces and consumes energy, constantly exchanging heat with the surrounding environment both inside and outside - © Saint-Gobain Multi-comfort Comic Book

temperature, air speed). People were asked to judge the sensation of hot and cold felt. The thermo-hygrometric environment is described by appropriate physical quantities.

One of the vital conditions for the humankind is the possibility of maintaining a constant temperature of his body and more specifically the temperature of the innermost body area, called nucleus, which includes the vital organs. This temperature must maintain the value of approximately 37 ° C with variations not exceeding about  $\pm 0,2$  ° C during the day.

The first Principle of Thermodynamics applied to the *human body* system, without considering variations of kinetic energy, potential, etc., can be written according to the following relation:

$$M - W - Q = dU / dt \quad (1)$$

where Q and W are positive when heat is lost and work is done by the human body, and  $dU / dt$  is the variation of the internal energy of the human body in a unit of time [W].

Exchanges of sensible and latent heat between Man and environment occur on the external surface of the human body and within the pulmonary cavity.

After some passage (1) could be write as the better known equation of Heat balance of the human body:

$$S = M \pm W \pm R \pm C \pm K - E - RES \quad (2)$$

where S = heat accumulation

M = metabolism

W = external work

R = heat exchanged for radiation

C = heat exchanged for convection

K = heat exchanged for conduction

E = heat loss for evaporation

RES = heat exchanged for respiration.

All terms are expressed as heat flux per unit of body surface, in W/m<sup>2</sup>. In stationary conditions the human body does not exchange heat, thus S=0.

Moreover the heat flux through the skin is loss for conduction (K) to the clothes and through the clothes to environment for radiation and convection (C+R). Thus,  $K_{clothes} = C+R$ , and so

$$(M \pm W) \pm - E - RES = K_{cl} \quad (3)$$

#### *Metabolic rate*

Traditionally, metabolism is measured in Met (1Met = 58,15 W/m<sup>2</sup> of body surface). A normal adult has a surface area of 1,7 m<sup>2</sup>, and a person in thermal comfort with an activity level of 1 Met will thus have a heat loss of approximately 100 W. Metabolism level is lowest when people sleep (0,8 Met) and at its highest during sports activities, where 10 Met is frequently reached.

Metabolic rate incorporates both  $M \pm W$ , because when a body does a work it loss energy through heat to compensate temperature increasing.

#### *Clo rate*

Clothing reduces the body's heat loss. Therefore, clothing is classified according to its thermal resistance value. The unit used for measuring clothing's insulation is the Clo unit (1 Clo = 0,155 m<sup>2</sup>·°C/W). The equation represents the heat transfer by conduction between the skin and the clothes.

$$K_{cl} = (T_s - T_{cl}) \cdot (0,155 \text{ Clo})^{-1} \quad (4)$$

where  $T_{cl}$  is the mean temperature of clothes.

#### *Respiration*

The heat lost through breathing is due to two components: the first one is the difference in temperature between the expired air and the ambient temperature, the second one is the difference in relative humidity.

$$RES = C_{RES} + E_{RES} = 0,014 M \cdot (34 - t_a) + 1,72 \cdot 10^{-5} M (5.867 - p_a) \quad (5)$$

where  $p_a$  is vapor pressure at ambient air temperature.

#### *Evaporation*

It is the latent heat lost to the environment by the evaporation of the water contained in the skin. There are two mechanisms by which the water contained within the body evaporates from the skin, namely transpiration  $E_d$  (vapor diffusion through the skin) and evaporation through sweating  $E_{sw}$ .

$$E = E_d + E_{sw} = 3,05 \cdot 10^{-3} [5.733 - 6,99 \cdot (M - W - p_a)] + 0,42 \cdot (M - W - 58,15) \quad (6)$$

### Radiation

It represents the heat flow exchanged by radiation between the person and the surrounding surfaces (walls, windows, radiant panels, sun, star vault, etc.):

$$R = 3,95 \cdot 10^{-8} \cdot f_{cl} \cdot [T_{cl}^4 - T_r^4] \quad (7)$$

where  $f_{cl}$  is clothing surface factor  
 $T_r$  is the mean radiant temperature.

### Convection

The equation represents the thermal flow exchanged by convection:

$$C = f_{cl} \cdot h_{cl} \cdot (T_{cl} - T_a) \quad (8)$$

where  $h_{cl}$  is the coefficient of convective exchange.

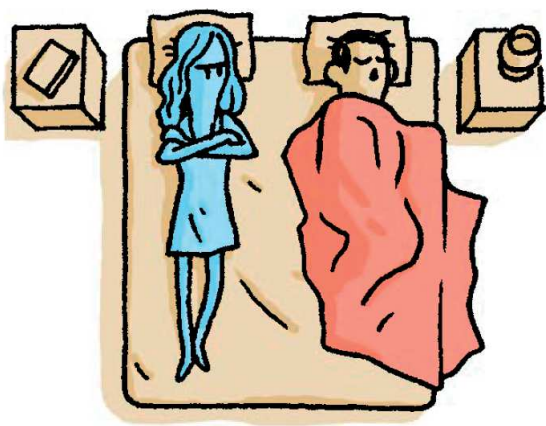

Figure 95/ Even gentle fluctuations marke us all with pleasure or discomfort - © Saint-Gobain Multi-comfort Comic Book

### Comfort equations of Fanger

The previous equations can be written as a function of six known quantities:

$$M, Clo, t_a, T_r, u_a, p_a (\varphi), T_s, E_{sw}, T_{cl}.$$

Thus there are 2 equations in 9 variables, corresponding to 1 equation in 8 variables. Having 1 equation in 6 known variables means finding other 2 equations.

The two remaining equations were obtained by Fanger precisely through experimental tests on people, and are expressly related to conditions of comfort, therefore added to the previous equations make the system of equations overall a system related to thermo-hygrometric comfort. These two equations express:

- the dependence of heat lost on metabolism sweating, and has already been mentioned ( $E_{sw}$ )
- the temperature that the skin must have (depending on the metabolism) because the person does not feel sensations of heat or cold (it is clear that if the metabolism increases, the skin temperature must decrease to have comfort).

$$T_s = 35,7 - 0,0275 \cdot (M - W) \quad (9)$$

However the comfort equation establish the perfect equilibrium of factors in a determine environment, it is a common experience that the sensation of heat, cold, and the absence of such sensations do not occur at a precise value, but in a certain interval. This is the called individual comfort interval. Experimentally there is an interval of at least  $1^\circ\text{C}$  in which the body adapts to the environment and the sensation of heat and cold are not perceived. Moreover, even if the conditions of the comfort equation are perfectly respected, there will always be a certain number of people experiencing discomfort (hot or cold).

The PMV-index predicts the mean value of the subjective ratings of a group of people in a given environment.

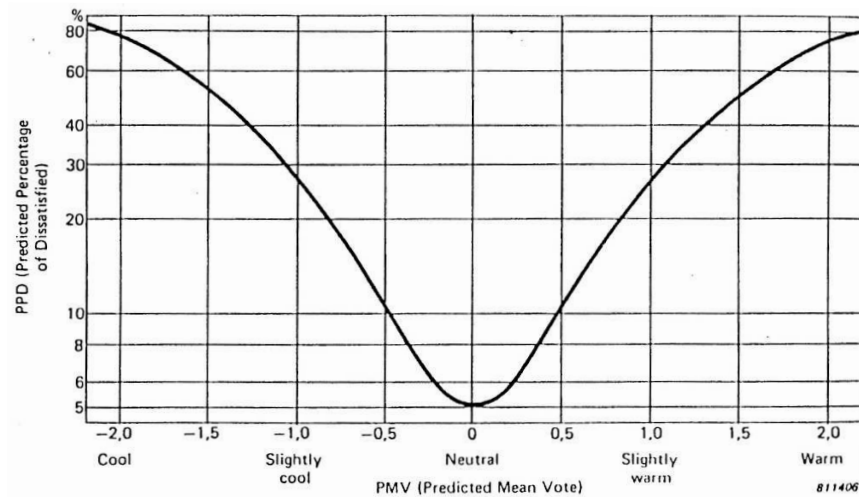

Figure 96 / Relation between PMV and PPD, 1973 - P. O. Fanger

Predicted Mean Vote (PMV) is a seven-point thermal-sensation scale ranging from -3 (cold) to +3 (hot), where 0 represents the thermally neutral sensation.

Each integer value of the PMV scale indicates the following:

- 3: Cold
- 2: Cool
- 1: Slightly Cool
- 0: Neutral
- +1: Slightly Warm
- +2: Warm
- +3: Hot.

The range of comfort is generally accepted as a PMV between -1 and +1. Exceeding +1 will result in an uncomfortably warm occupant while dropping below -1 will result in an uncomfortably cool occupant. PMV is a *mean* vote because it is meant to represent the average vote of all people under the input conditions.

To predict how many people are dissatisfied in a given thermal environment, the PPD-index (Predicted Percentage of Dissatisfied) has been

introduced. In the PPD-index people who vote -3, -2, +2, +3 on the PMV scale are regarded as thermally dissatisfied.

$$PMV = (0,303 \cdot e^{-0,036 M} + 0,028) \cdot [M - W - E_d - E_{sw} - E_{RES} - W - C_{RES} - R - C] \quad (10)$$

$$PPD = 100 - 95 \cdot e^{-(0,033 PMV^4 + 0,217 PMV^2)} \quad (11)$$

Considering that, despite the high quality design strategies used to guarantee the control of the thermo-hygrometric conditions, there is always a non-negligible percentage of dissatisfied, it is preferred to have a greater tolerance in the design conditions. ISO 7730 admits a percentage of dissatisfied people by 10%, that is a PMV between -0,5 and +0,5. In this way the designer has a wider range of temperatures, relative humidity, etc., which the system must guarantee.

### Psychrometric charts

In his *Introduction to Architectural Science*<sup>5</sup>, Steven Szokolay says that the first step in any bioclimatic design approach is to examine the given climate and establish the nature of the climatic problem: relate the climate to human requirements. A good way of doing this is to use the psychrometric chart as the base. Szokolay<sup>6</sup> explains the main concepts as follows.

*Heat* is a form of energy, contained in substances as molecular motion appearing as electromagnetic radiation in space. For the Secondo Principle of Thermodynamics: heat transfer can take spontaneously in one direction only, from the hotter body to the cooler one.

*Temperature* is the symptom of the presence of internal energy in a substance [K].

The *specific heat* concept provides the connection between internal energy and temperature and is the quantity of heat required to elevate the temperature of unit mass of a substance by one degree, thus it is measured in units of [J/kg•K].

The *latent heat* is the amount of energy absorbed by unit mass of the substance at change of state (from solid to liquid or liquid to gaseous) without any change in temperature. This is measured in [J/kg].

*Heat flows* from a higher temperature zone (or body) to a lower temperature one. Heat flow can take place in three forms:

□ Conduction within a body or bodies in contact, by the *spread* of molecular movement. Conduction depends on a property of the material known as conductivity ( $\lambda$ ), measured as the heat flow density ( $W/m^2$ ) in a 1-m thick body (i.e. the length of heat flow path is 1 m), with a one degree temperature difference, in units of  $W \cdot m/m^2K = W/m \cdot K$ . Determine the heat flow require a quantity that takes in count boundary effects and thickness of the material, Transmittance, or U-value includes the surface effects. This is the heat flow density ( $W/m^2$ ) with 1K temperature difference ( $\Delta T$ ) between air inside and air outside in units of  $W/m^2K$ .

$$Q = A \times U \times \Delta T \quad [m^2 \cdot W / (m^2 \cdot K) \cdot K = W] \quad (12)$$

□ Convection from a solid body to a fluid (liquid or gas) or vice-versa. The magnitude of convection heat flow rate depends on:

- area of contact ( $A, m^2$ ) between the body and the fluid;
- the difference in temperature ( $\Delta T$ , in K) between the surface of the body and the fluid;
- a convection coefficient ( $h_c$ ) measured in  $W/m^2 \cdot K$ , which depends on the viscosity of the fluid and its flow velocity as well as on the physical configuration that will determine whether the flow is laminar or turbulent.

$$Q_v = A \times hc \times \Delta T \quad [m^2 \cdot W / (m^2 \cdot K) \cdot K = W] \quad (13)$$

□ Thermal radiation is a wavelength band of electromagnetic radiation, normally taken as short infrared and long infrared. The temperature of the emitting body determines the wavelength. The sun with its 6000°C

surface emits short infrared (as well as visible and ultraviolet) radiation, bodies at terrestrial temperatures ( $<100^\circ C$ ) emit long infrared radiation. This equation express the amount of thermal power aboserded by a body:

$$Q_s = A \cdot G \cdot \alpha \quad [m^2 \cdot W / m^2 \cdot K \cdot \text{dimensionless} = W] \quad (14)$$

Where  $G$  is the global irradiance and  $\alpha$  the absorptance of the material (usually  $0,2 < \alpha < 0,9$  in comparison with the theoretical ideal absorber black body for which  $\alpha=1$ )

*Humid air: psychrometry*

At any given temperature the air can only support a limited amount of water vapour (saturation). The basic structure of the psychrometric chart: dry bulb (air-)temperature on the horizontal axis and moisture content (or absolute humidity, AH) on the vertical axis.

The top curve is the saturation line, indicating the maximum moisture content the air could support at any temperature, which is the saturation humidity (SH). Each vertical ordinate can be and the curves connecting these points show the relative humidity (RH) in percentage, i.e. as a percentage of the saturation humidity.

The difference dry bulb temperature (DBT)– wet bulb temperature (WBT) is referred to as the wet bulb depression and it is indicative of

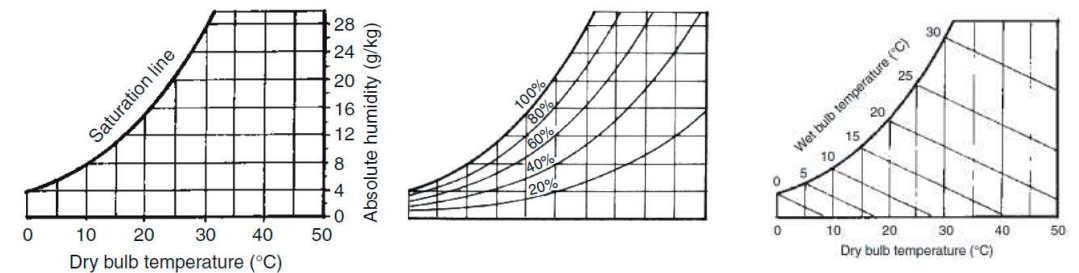

Figure 97 / ◀ Structure of the psychrometric chart ▲ Relative humidity curves ▶ Wet bulb temperature lines - © Steven Szokolay

the humidity. The wet-and-dry bulb (whirling) psychrometer is a good instrument for measuring DBT and WBT. Evaporation from the wick has a cooling effect, which causes the wet bulb depression. Evaporation is inversely proportional to humidity. In saturated air there is no evaporation, no cooling, thus WBT = DBT. With low humidity there is strong evaporation, strong cooling and a large wet bulb depression.

Sloping WBT lines on the psychrometric chart coincide with the DBT at the saturation curve. A measured status point could be marked on the psychrometric chart as the intersection of the DBT and WBT lines and permits to read both the RH and the AH.

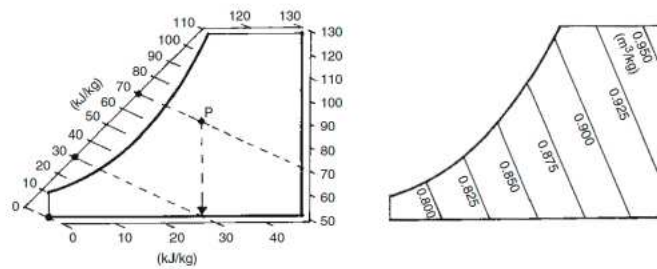

Figure 98 / ◀ Enthalpy scales externally: (H) is the energy content of the air relative to 0°C and 0 humidity ▶ Specific volume lines represent the volume of air occupied by 1 kg of air (at normal pressure), in m<sup>3</sup>/kg. It is the reciprocal of density, kg/m<sup>3</sup> - © Steven Szokolay

*Passive controls*

The psychrometric chart allows to define the processes, the changes and the strategies that can be traced on the chart.

*Sensible heating* is represented by the status point moving horizontally to the right. As the DBT increases, with no change in moisture content, the relative humidity is reducing.

*Sensible cooling* lowers the DBT, the status point moves horizontally to the left. This causes the RH to increase, but the AH is not changed. Where this horizontal line reaches the saturation curve, the dewpoint temperature

re (corresponding to the given AH) can be read.

*Humidification*, i.e. evaporation of moisture into an air volume is adiabatic if no heat is added or removed. This causes a reduction of temperature (DBT) but an increase of humidity (both AH and RH). The status point moves up to the left, along a constant WBT line.

*Adiabatic dehumidification* takes place when air is passed through some chemical sorbent (solid, such as silica gel, or liquid, such as glycol spray) which removes some of the moisture content (by absorption or adsorption). This process releases heat, thus the DBT will increase, whilst the humidity (both AH and RH) is reduced.

Szokolay<sup>7</sup> defines a zone of psychrometric chart individuated by the range of outdoor conditions for which each passive strategy has the potential to ensure indoor comfortable conditions, this zone is called Control Potential Zone (CPZ).

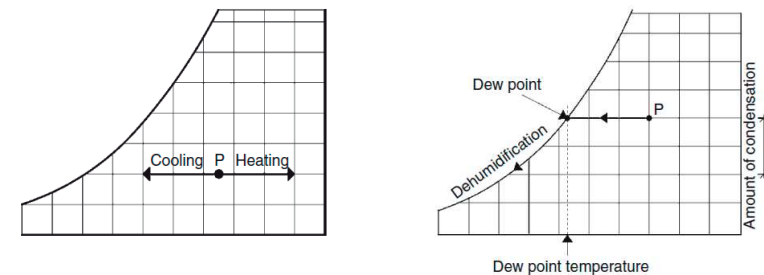

Figure 99 / ◀ Cooling and heating: movement of the status point ▶ Cooling to reduce humidity - © Steven Szokolay

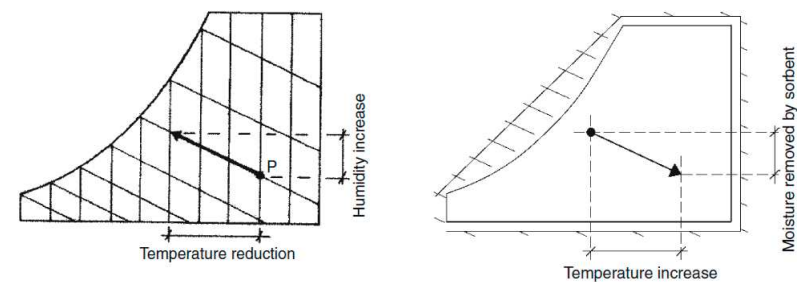

Figure 100 / ◀ Evaporative cooling: humidification ▶ Adiabatic dehumidification - © Steven Szokolay



*Passive solar heating*

The passive strategy of solar heating is allowed by the control of solar radiation through the openings. A good exposition together with good shading systems provide an important gain of solar radiation inside the buildings. In accord with Szokolay<sup>8</sup>, a good window must perform five functions:

- provide a view
- admit daylight
- reduce heat loss
- admit solar heat (in a cold situation)
- allow controllable ventilation.

Passive solar heating can be estimated by comparing the solar gains through vertical equator-facing surfaces with the heat loss through the same surface. The CPZ boundaries are individuated by the following (15):

$$D_v \cdot A \cdot \eta = q \cdot (T_i - T_o) \cdot 24 \tag{15}$$

where

$D_v$  = vertical irradiation(Wh/m<sup>2</sup>day)

$A$  = area of solar aperture

$\eta$  = efficiency (utilizability), taken as 0,5 or 0,7

$q$  = qc + qv, building thermal conductance (W/K)

$T_i$  = indoor temperature limit

$T_o$  = the limiting operative temperature to be found.

*Thermal mass*

During the day, a massive envelope allows to reduce overheating and store heat that will be released at night. According to Szokolay<sup>9</sup> CPZ boundaries are defined according to the following principle: in a very massive building the indoor temperature would be practically constant at about the level of the outdoor mean calculated as:

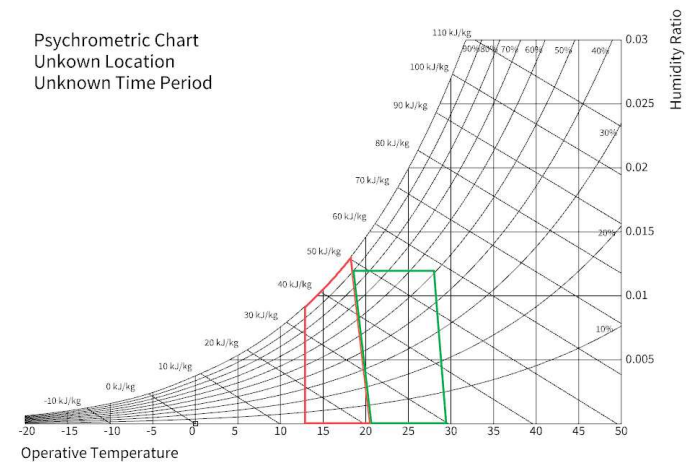

Figure 101 / Green: comfort zone; red: CPZ for passive solar heating

$$(T_{0,max} - T_{0,min}) \cdot 0,5 \tag{16}$$

But for the reason that the building does not decrease the temperature down to the minimum, the amplitude of CPZ reduce to:

$$(T_{0,max} - T_{0,min}) \cdot 0,3 \tag{17}$$

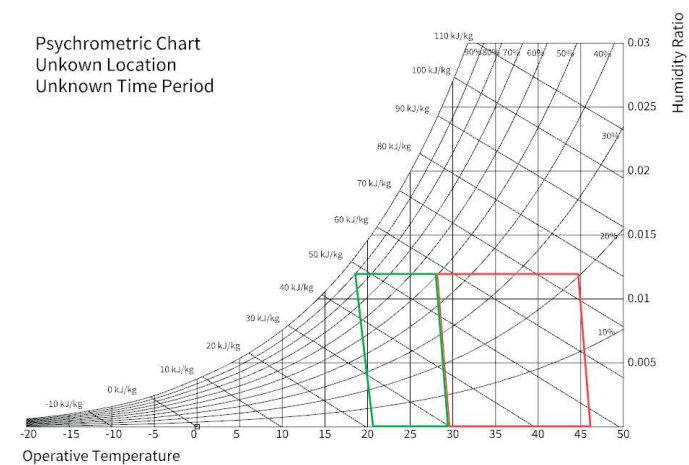

Figure 102 / Green: comfort polygon; red: CPZ for thermal mass

### Natural ventilation

It is allowed when the building admits air mass exchange with the outdoor. Natural ventilation can be actuated by two principal design strategies:

- Stack effect: when the air inside a vertical stuck is warmer than the outside. Warmer air rises and will be replaced by colder air entering at the bottom. There must be both enough height and temperature differences.
- Cross ventilation: The difference between positive pressure on the windward side and negative pressure on the leeward side provides the driving force.

The cooling potential can be calculated as:

$$\text{For } 1 \text{ m/s air velocity} \quad dT = 6 \cdot 0,8 - 1,6 \cdot 0,82 = 3,8\text{K} \quad (18)$$

$$\text{For } 1,5 \text{ m/s air velocity} \quad dT = 6 \cdot 0,8 - 1,6 \cdot 1,32 = 5,1\text{K} \quad (19)$$

To define the CPZ for air movement effect these  $dT$  values are added to the upper comfort limit along the 50% RH curve.

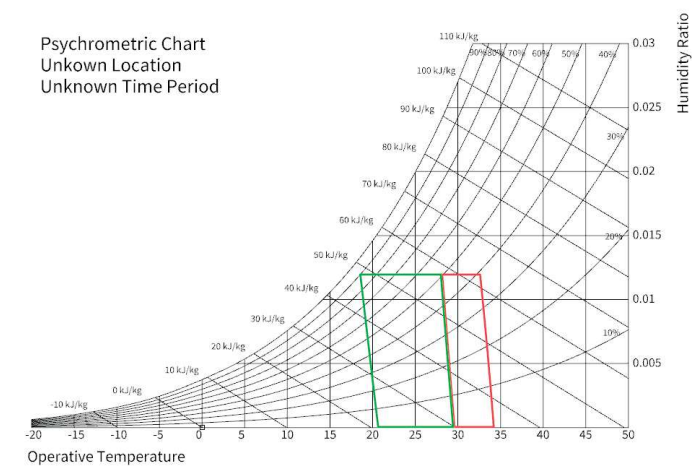

Figure 103 / Green: comfort polygon; red: CPZ for natural ventilation

Figure 104 / ◀ 2226 / Baumschlagler Eberle Architekten 2013 - the building has no heating, ventilation or cooling system, the flow of energy being controlled by software. 22-26 is the range of operative temperatures during the year - © Eduard Hueber - via commons.wikimedia.org

*Evaporative cooling*

It can be provided as part of a passive system, e.g. by a roof pool or a courtyard pond, or by a spray over the roof or some other building surface. If evaporation occurs within an enclosed space, it may lower the DBT, but it increases the humidity, therefore the latent heat content, in effect it converts sensible heat to latent heat.

The total heat content of the system does not change, thus it is an adiabatic process. If the evaporation rate (er, in kg/h) is known, the corresponding heat loss will be:

$$Q_e = (2400/3600) \cdot er = 0,666 \cdot er \tag{20}$$

where 2400 kJ/kg is the latent heat of evaporation of water.

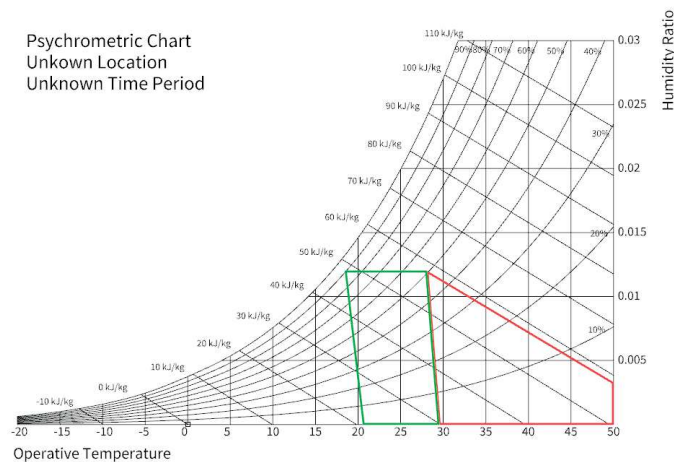

Figure 105 / Green: comfort polygon; red: CPZ for evaporative cooling

**Building performance simulation**

The validation of thermo-physical performances of an innovative pre-fabricated housing module pass through many phases of simulation and laboratory tests.

Dynamic thermo-physical simulations are effective designing methods thanks to the conversion of environmental performance needs into desi-

gn hypothesis. Indeed, through simulated responses of the designed building, the designer has the possibility to change environmental parameters, by varying technological components, materials stratigraphy, global configuration, orientation or technical systems. Dynamic simulation are design tools able to solve issues and improve performances, by perfecting adaptive parameters.

- Steady state conditions:
  - stable temperature over a several-hour period
  - calculations for worst case conditions
  - including no solar gains nor internal gains
  - the resulting sum of heat flows out of a building is corresponds to design heating load.
- Dynamic simulations:
  - hourly weather data fort the whole year
  - considers conduction and convection between zones
  - solar gains through openings and shading
  - internal gains and HVAC

Figure 106 / Ladybug tools scheme - www.food4rhino.com

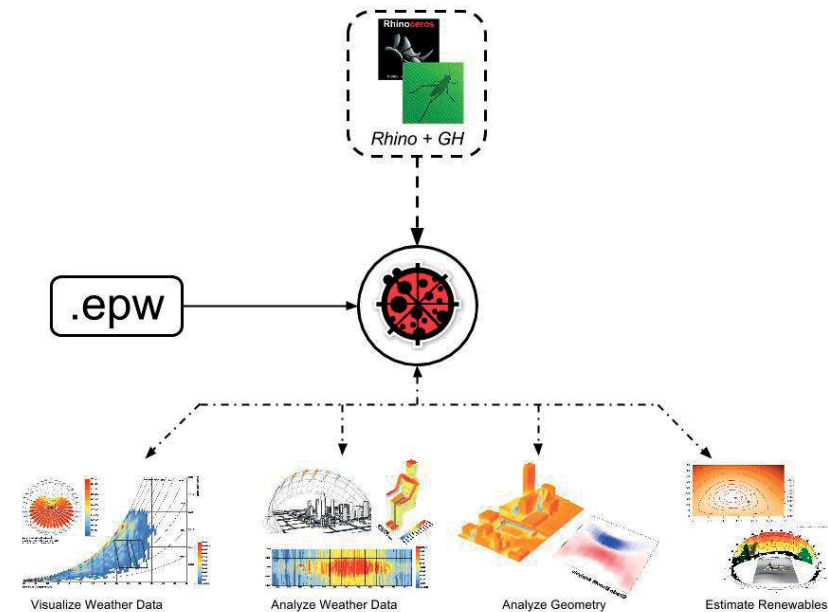

- warm up of the building.

*Ladybug* and *Honeybee* are plugins of *Grasshopper 3D*, which is an open source parametric design tool that operates on *Rhinceros*. *Ladybug* allows to: import and analyse standard weather data (EPW) in *Grasshopper*; draw diagrams like sun-path, wind-rose, radiation-rose, etc.; customize the diagrams in several ways; carry out radiation analysis, shadow studies, and view analysis.

*Honeybee* connects *Grasshopper 3D* to validated simulation devices such as *EnergyPlus*, *Radiance*, *Daysim* and *OpenStudio*, for building energy, comfort, daylighting and lighting simulation.

*The success achieved through the use of standard, text-readable formats initially depends on a tool being modularized into discrete elements that can pass this standardized data back and forth. The more modularized that a tool is, the more locations that exist for people to input/export*

Figure 107 / Honeybee tools scheme - [www.food4rhino.com](http://www.food4rhino.com)

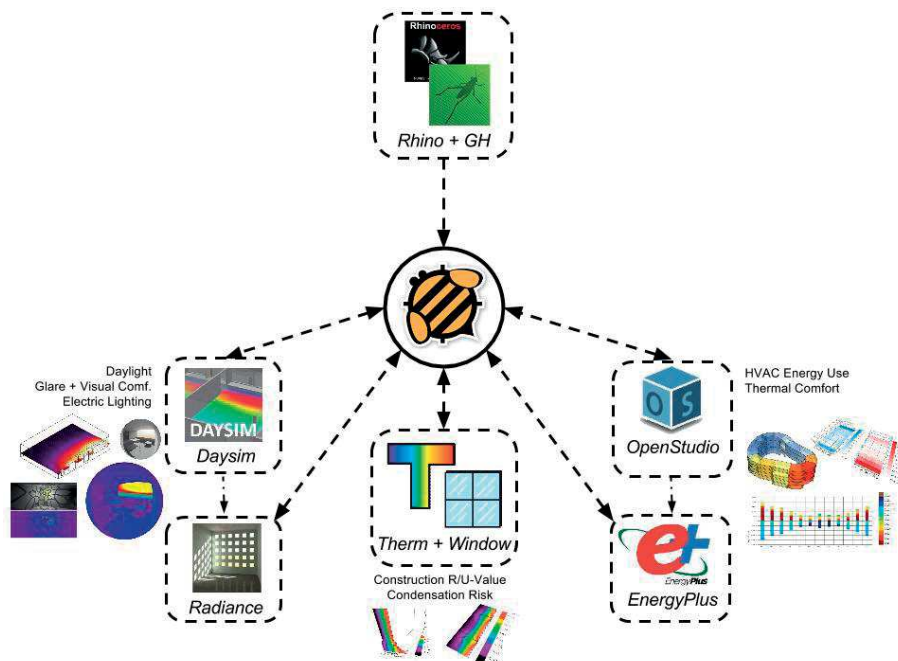

*custom data, build extensions on top of the tool, and connect it to other software. From this principle, we can understand that VPL plugins will be more successful at integrating into toolkits if they break down their functions into more and more components or nodes. This is something that *Ladybug Tools* takes to heart since it is very rare to run an entire study with a single component.*

Christopher Mackey and Mostapha Sadeghipour Roudsari<sup>10</sup>

*EnergyPlus* is a whole building energy simulator that is useful to modeling both energy consumption-for heating, cooling, ventilation, lighting and plug and process loads-and water use in buildings. Some of the notable features and abilities of *EnergyPlus* include:

- integrating simultaneous solution of thermal zone conditions and HVAC system responses, it emerges that HVAC system is not able to find zone loads and simulate un-conditioned and under-conditioned spaces on its own;
- heat balance-based solution of radiant and convective effects that produce surface temperatures, thermal comfort and condensation calculations;
- sub-hourly, user-definable time steps for interaction between thermal zones and the environment; with automatically varied time steps for interactions between thermal zones and HVAC systems. They allow *EnergyPlus* to emulate systems with fast dynamic, while also balance simulation speed for precision;
- combined heat and mass transfer model that accounts for air movement between zones;
- advanced fenestration models, including controllable window blinds, electrochromic glazing, and layer-by-layer heat balances, that calculate solar energy absorbed by window panes;
- illuminance and glare calculations for reporting visual comfort, and driving lighting controls;

- component-based HVAC that supports both standard and novel system configurations.

*OpenStudio* is a cross-platform (Windows, Mac, and Linux) collection of software tools for supporting whole building energy modelling, using EnergyPlus, and advanced daylight analysis, using Radiance.

*Radiance* is a suite of programs for the analysis and visualization of lighting in design.

Input files specify the scene geometry, materials, luminaires, time, date and sky conditions (for daylight calculations). Calculated values include spectral radiance (i.e. luminance + colour), irradiance (illuminance + colour) and glare indices. Simulation results may be displayed as coloured images, numerical values and contour plots.

The principal advantage of Radiance over simpler lighting calculation and rendering tools is that it has few limitations on the geometry and materials that may be simulated. Radiance is used by architects and engineers, to calculate illumination, visual quality and appearance of innovative design spaces and by researchers, to evaluate new lighting and daylighting technologies.

*DAYSIM* is a validated, Radiance-based daylighting analysis software that emulates the annual amount of daylight in and around buildings. *DAYSIM* allows users to emulate dynamic façades systems ranging from standard venetian blinds to state-of-the-art light redirecting elements, switchable glazing and their combinations. Moreover, users may specify complex electric lighting systems and controls, including manual light switches, occupancy sensors and photocell controlled dimming.

Simulation outputs range from climate-based daylighting metrics, such as daylight autonomy and useful daylight illuminance, to annual glare and electric lighting energy use. *DAYSIM* also generates hourly schedules for occupancy, electric lighting loads and shading device status that can be directly coupled with thermal simulation devices such as EnergyPlus.

## 5.3 Modular design

### Layout

#### Settlement

A human settlement derives from the structured landscape of a territory. It takes into consideration the spatial allocation of functions, while maintaining equilibrium among: population needs, availability and allocation of resources, economic dynamics, amelioration of living conditions, provision of services, communication and transportation networks, as well as recreational spaces. At large, a settlement addresses community needs. It includes service provision and encompasses socio-economic and

Figure 108 / Comparison between the settlements of three types of emergency housing systems: PC08 tent, container ISO 20 ft and Emergency Housing Solution S.A.E. 40m<sup>2</sup>

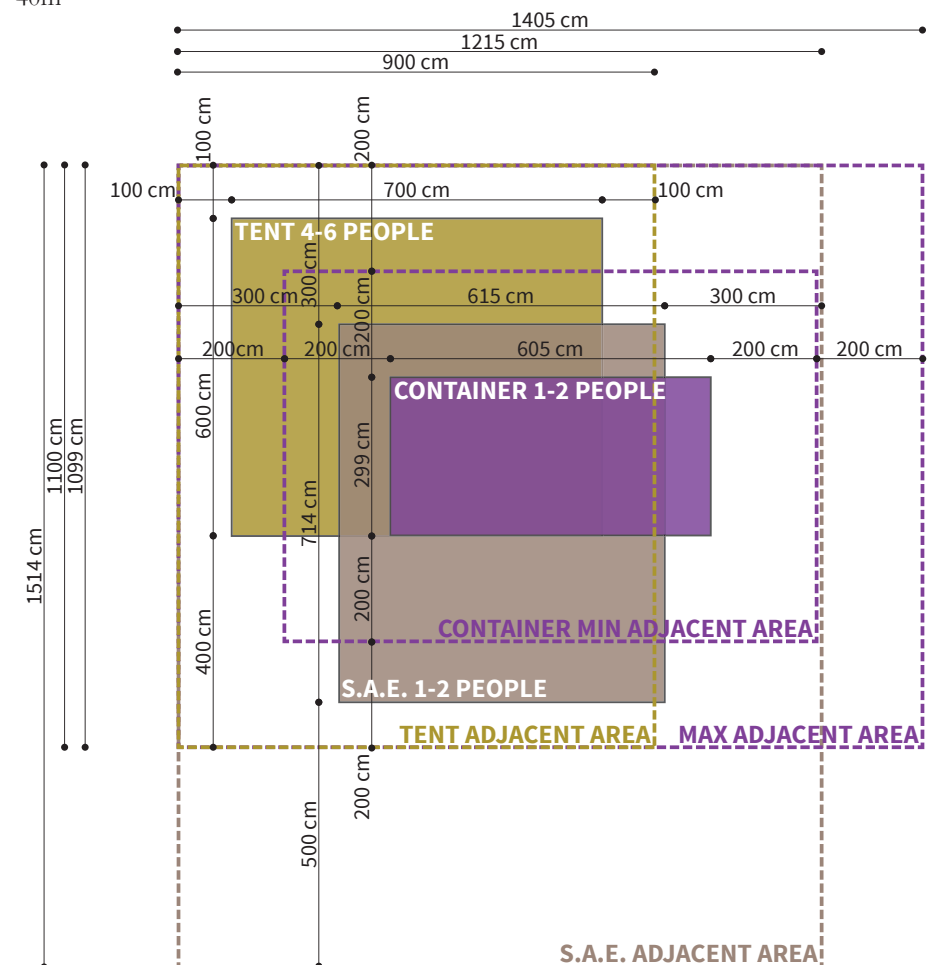

cultural dynamics. The design of a settlement might include all of these factors and it might consider that affected populations, partners, and all building sectors are actively involved in the design of a settlement<sup>11</sup>.

A comparison scheme of Civil Protection housing settlement types<sup>12</sup> allows to define a good square-meter extension for the adjacent private area of each cardboard housing module.

For this first step, it is supposed an extension of the module of about 700×500 cm.

The adjacent area is obtained as offset of building fronts:

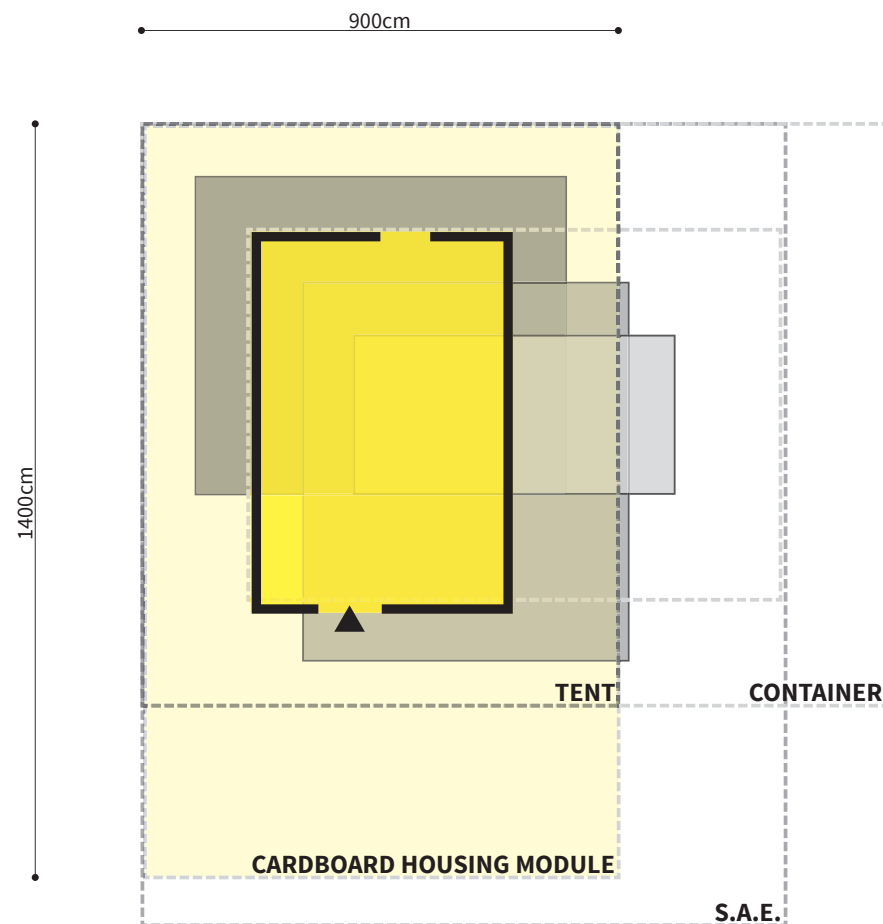

Figure 109 / Adjacent area for a rectangular-shaped cardboard housing module developed on N-S axis and elongated on N-S direction.

- from principal front 500 cm – according to technical guidelines to allow the plan of secondary penetration roads
- from secondary front 200 cm – average value among tents, containers and S.A.E.s settlements.

#### *Court settlement*

It is an aggregation system of 4, 5 or 6 prefabricated buildings surrounding an internal courtyard, which serves as an area of social relations. The system is closed to the outside, and there's only an internal pedestrian

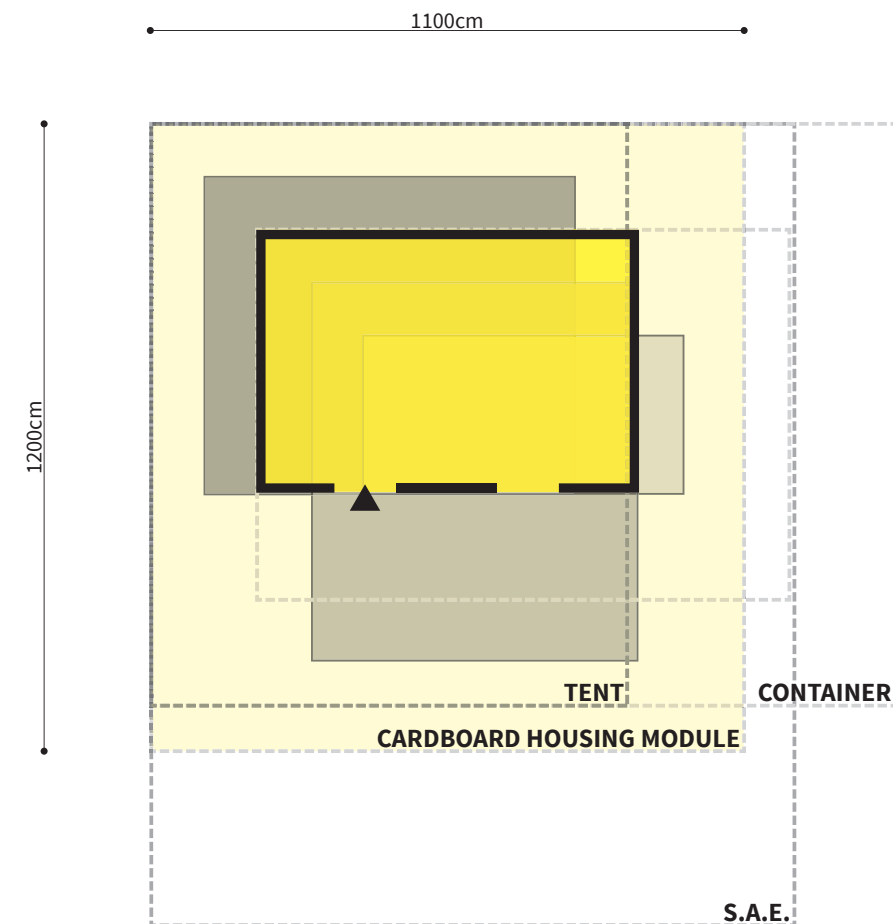

Figure 110 / Adjacent area for a rectangular-shaped cardboard housing module developed on N-S axis and elongated on E-W direction.

Figure 111 / Court settlement

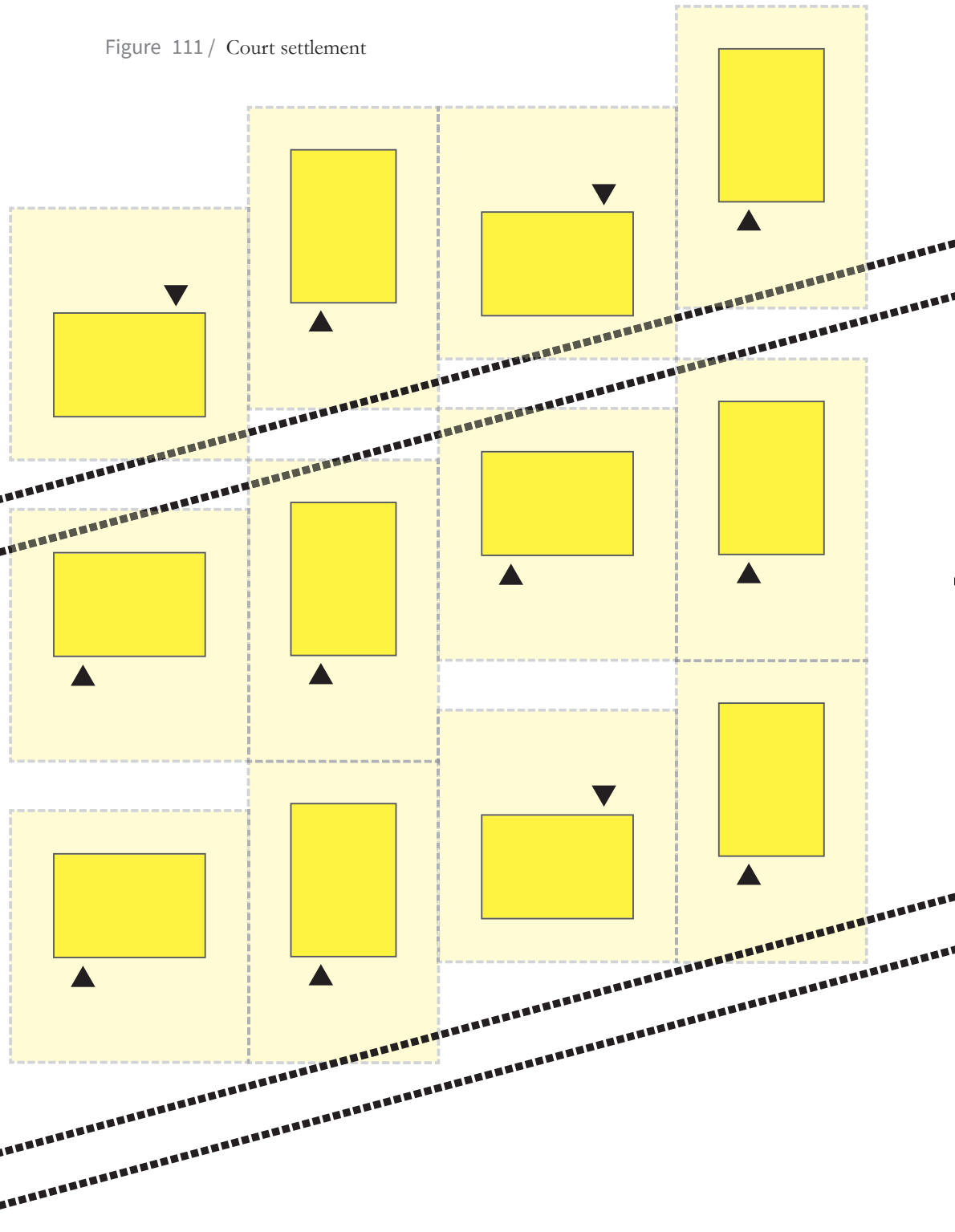
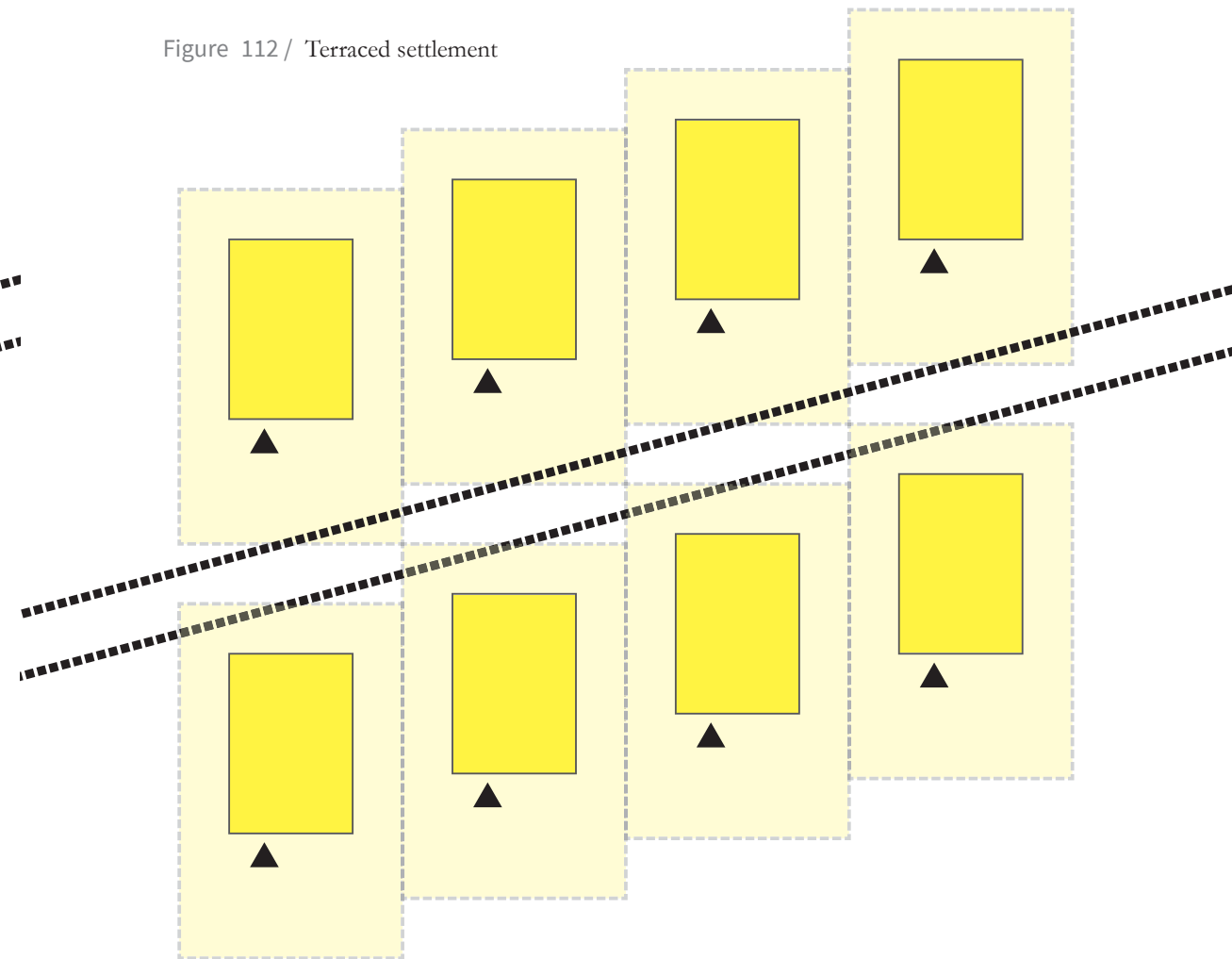

Figure 112 / Terraced settlement



passage between the modules. The morphology of the area allows the aggregation between neighbours.

#### *Terraced settlement*

It is the building type that allows to maximize the use of the most available area, adapting to smooth or particularly irregular surfaces. However, it is poorly functional, as it does not facilitate social aggregation.



### Orientation

The choice of the building orientation depends on the calculation of the best average of solar radiation between overheated period and under-heated one. This calculation will be explained in the next chapter through the case study, and it will be shown, for example, a comparison between a Civil Protection settlement (planned for the site of Dagala del Re in Santa Venerina, Catania, Italy), and the same settlement planned with the south orientation.

Figure 113/ ◀ Emergency settlement of DPC 80 m<sup>2</sup>, Santa Venerina, Catania, Italy 2003 - Guideline for design Regional Department of Civil Protection Eastern Sicily

Figure 114/ Example of terraced settlement south oriented, Santa Venerina, Catania, Italy

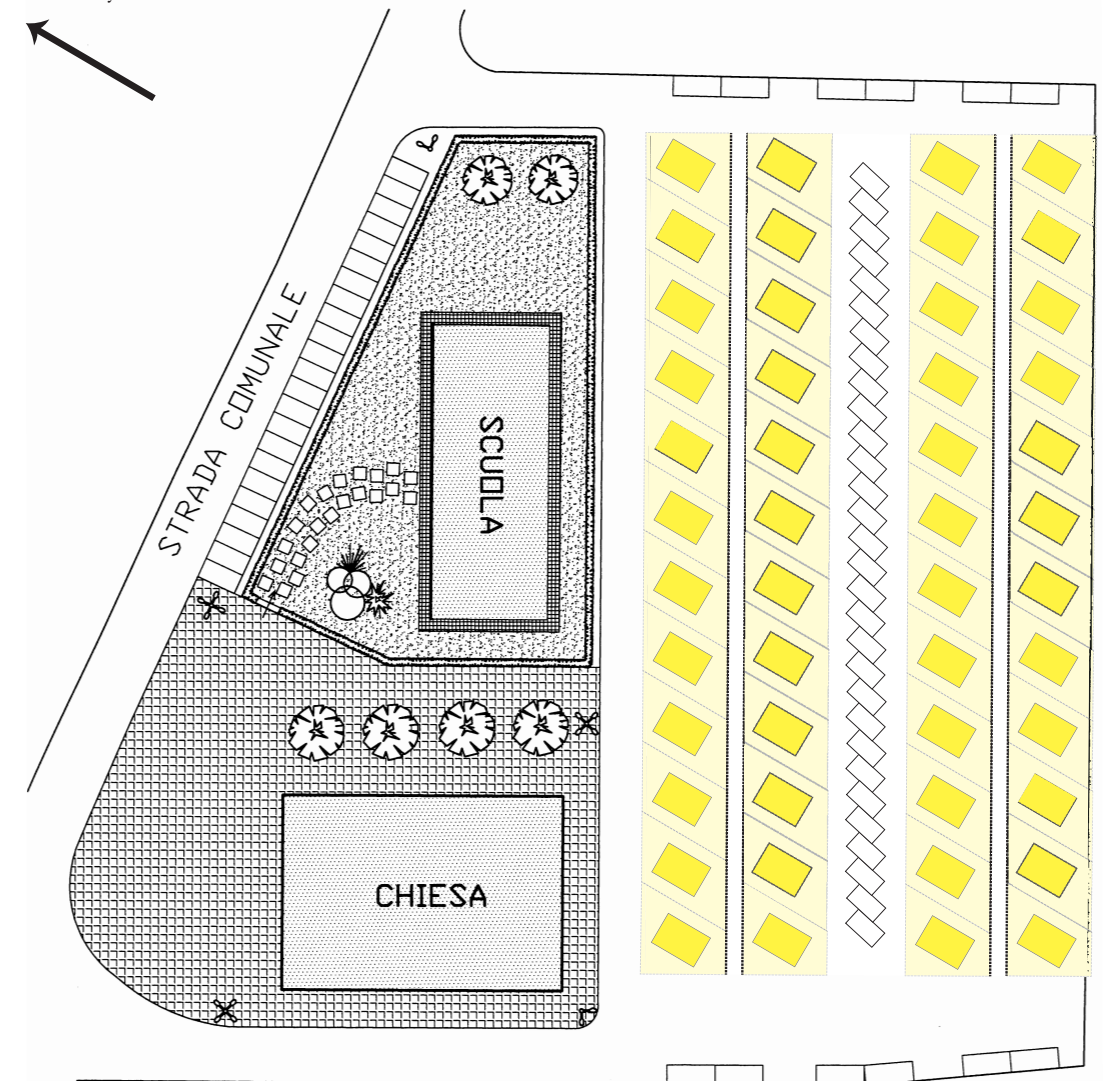
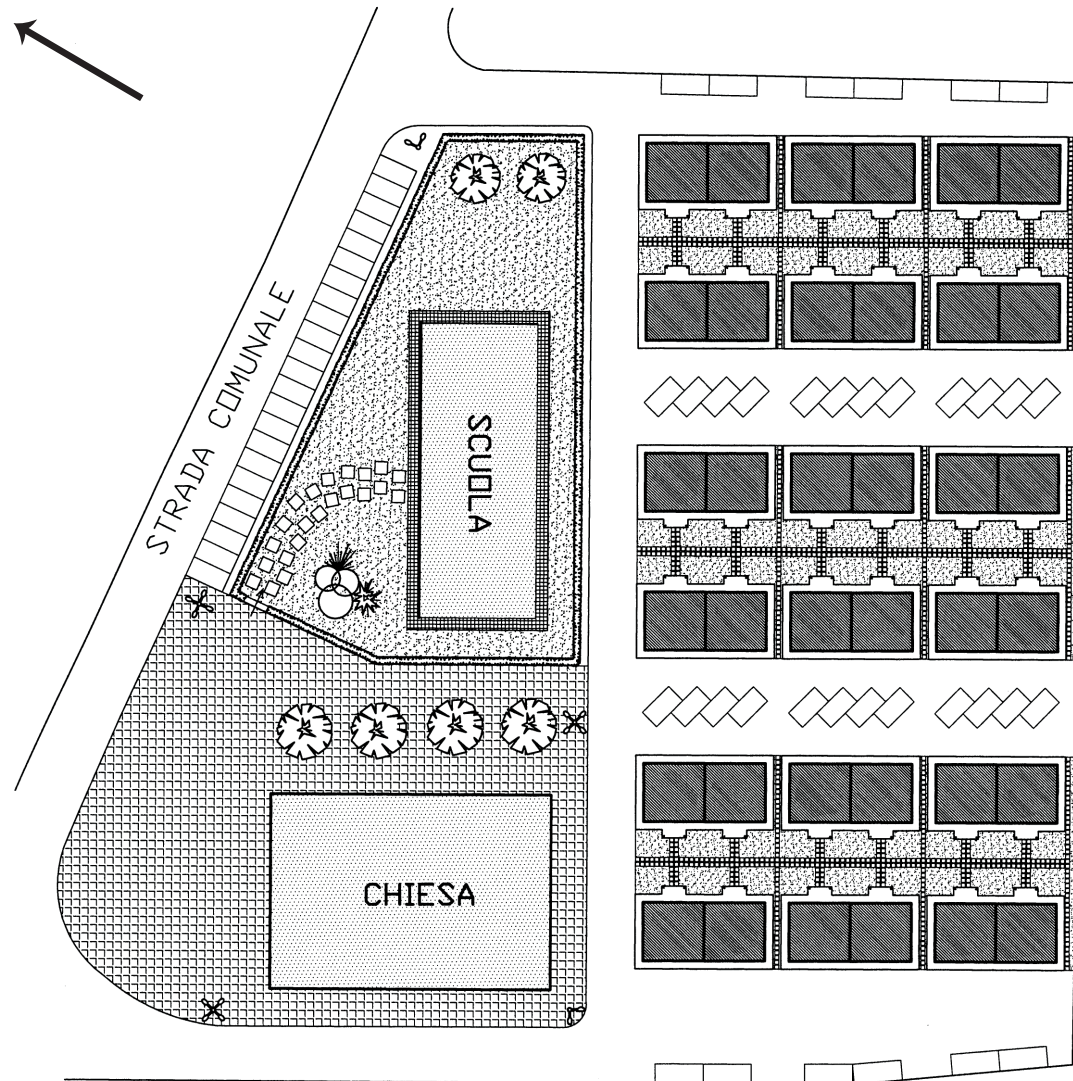



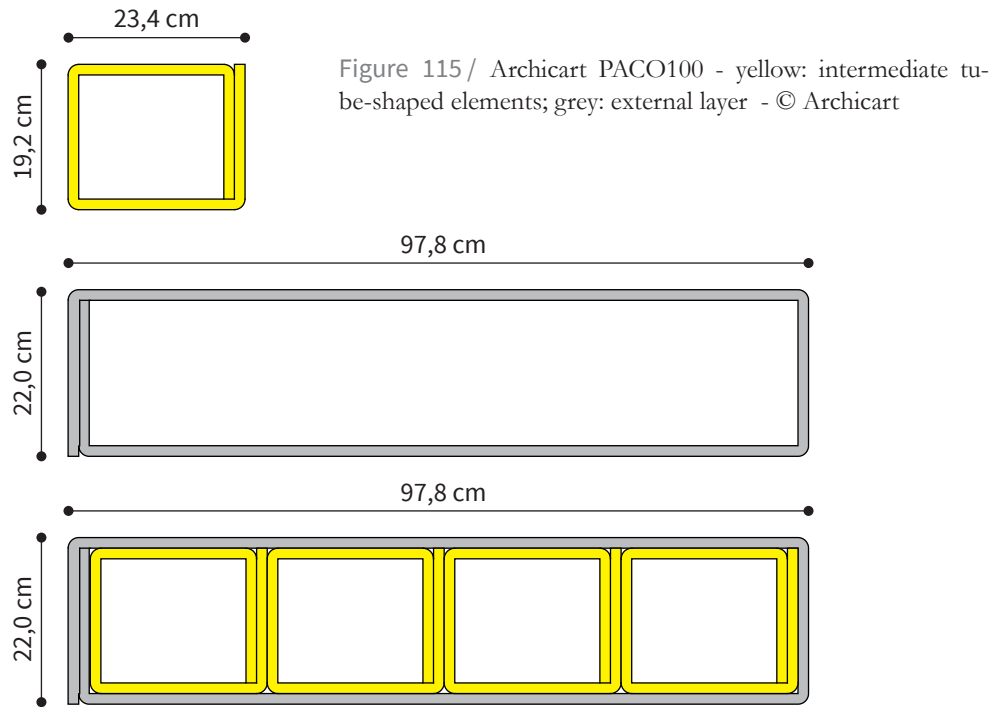

Figure 115/ Archicart PACO100 - yellow: intermediate tube-shaped elements; grey: external layer - © Archicart

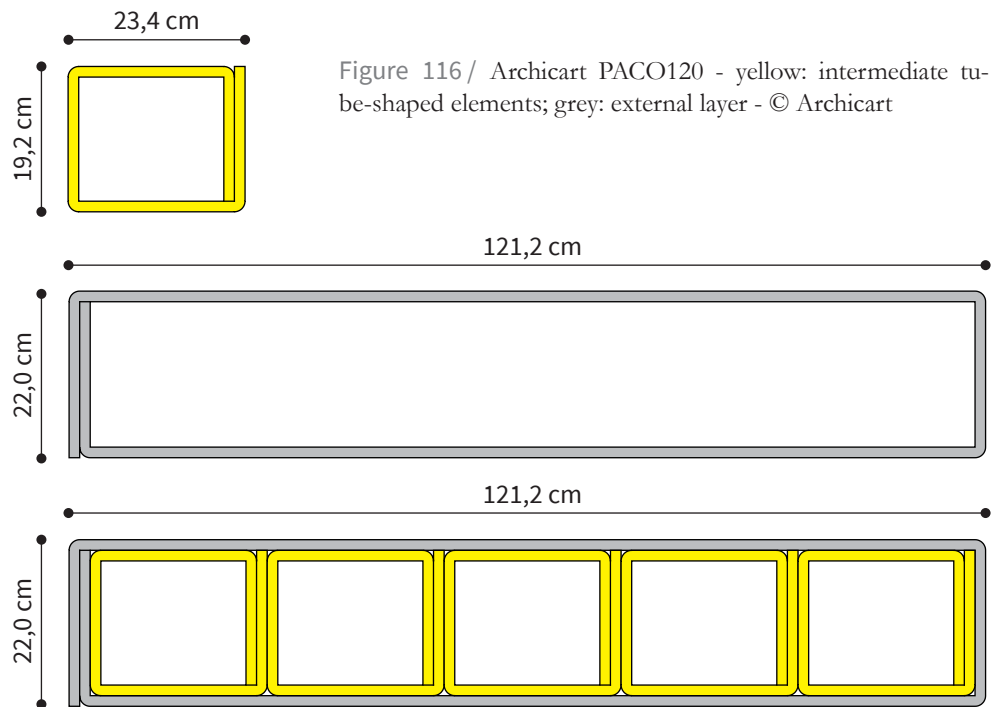

Figure 116/ Archicart PACO120 - yellow: intermediate tube-shaped elements; grey: external layer - © Archicart

**Types**

*Standard panels*

Dimensional and functional coordination based on modules is the practical connection among design, production and assembly. A modular system allows compatibility both for architectural and geometrical aspects of components. The result is the functional and dimensional correlation between one component with other different components.

The panels Archicart PACO are provided in several dimensions. The variable parameters of the industrial production are:

- size of intermediate tube-shaped elements (length, depth),
- number of intermediate tube-shaped elements inside external layer,
- height of the panel,
- types of connection.

The combination of these parameters allows to product several types of panels. The figures present a series of PACO characterized by final thickness of 22 cm and two different lengths (PACO120 – 121,2 cm and PACO100 – 97,8 cm) and a series of partitions panels (PACO90 - 90,0 cm). The figure presents the combination of final heights of PACO series that allow to match them with different kind of building configurations.

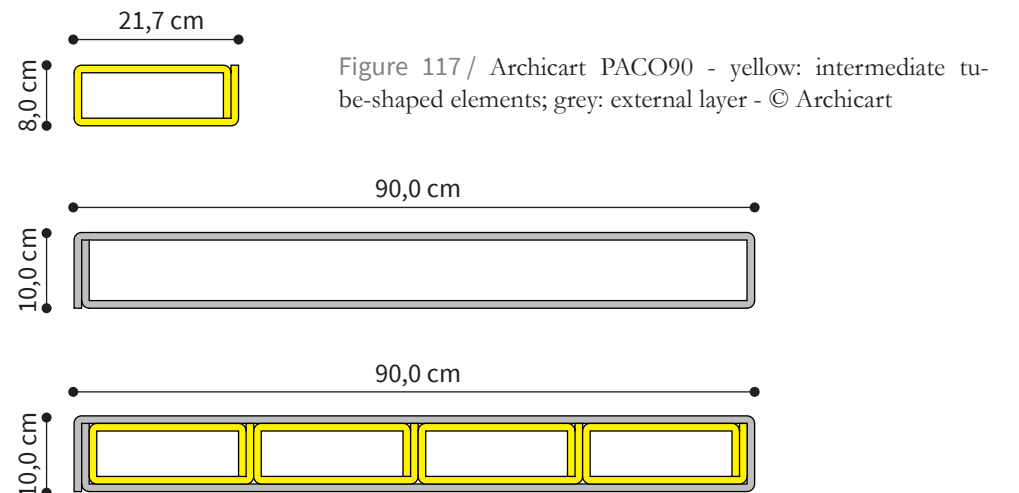

Figure 117/ Archicart PACO90 - yellow: intermediate tube-shaped elements; grey: external layer - © Archicart

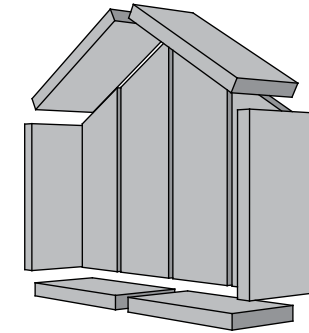
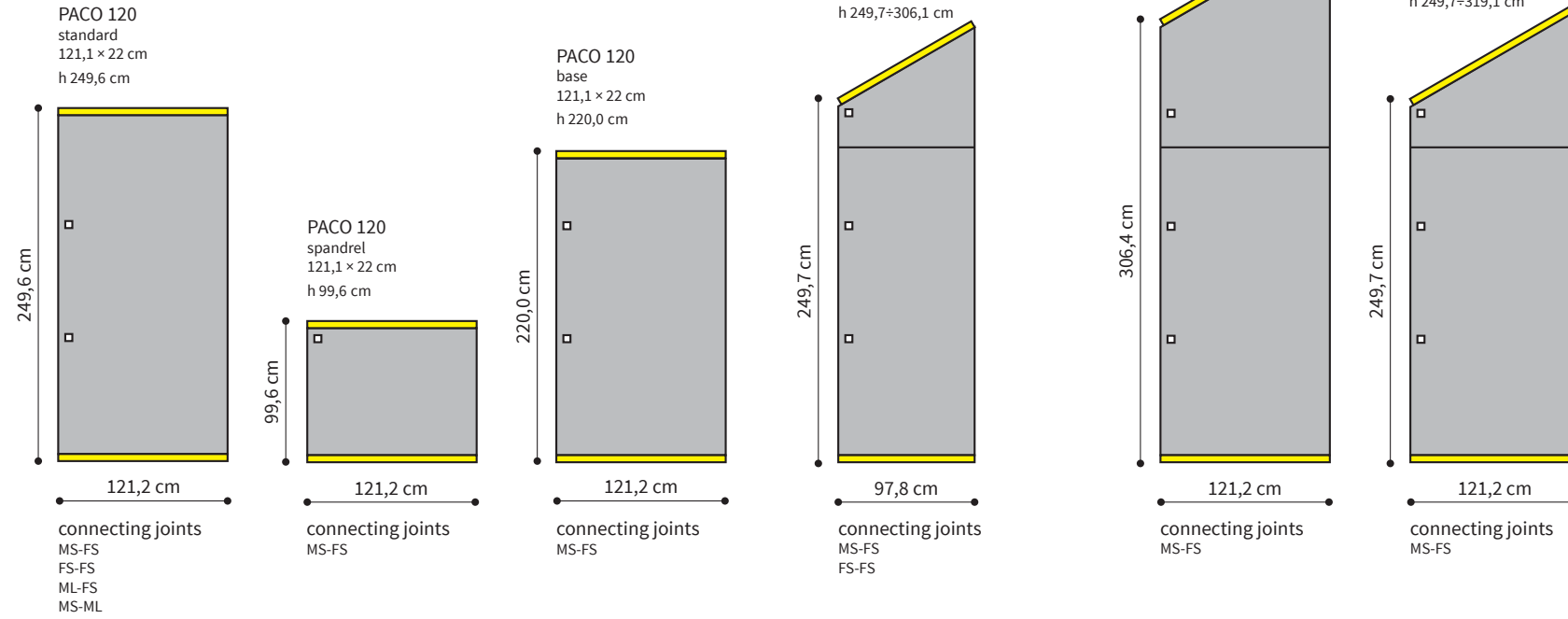
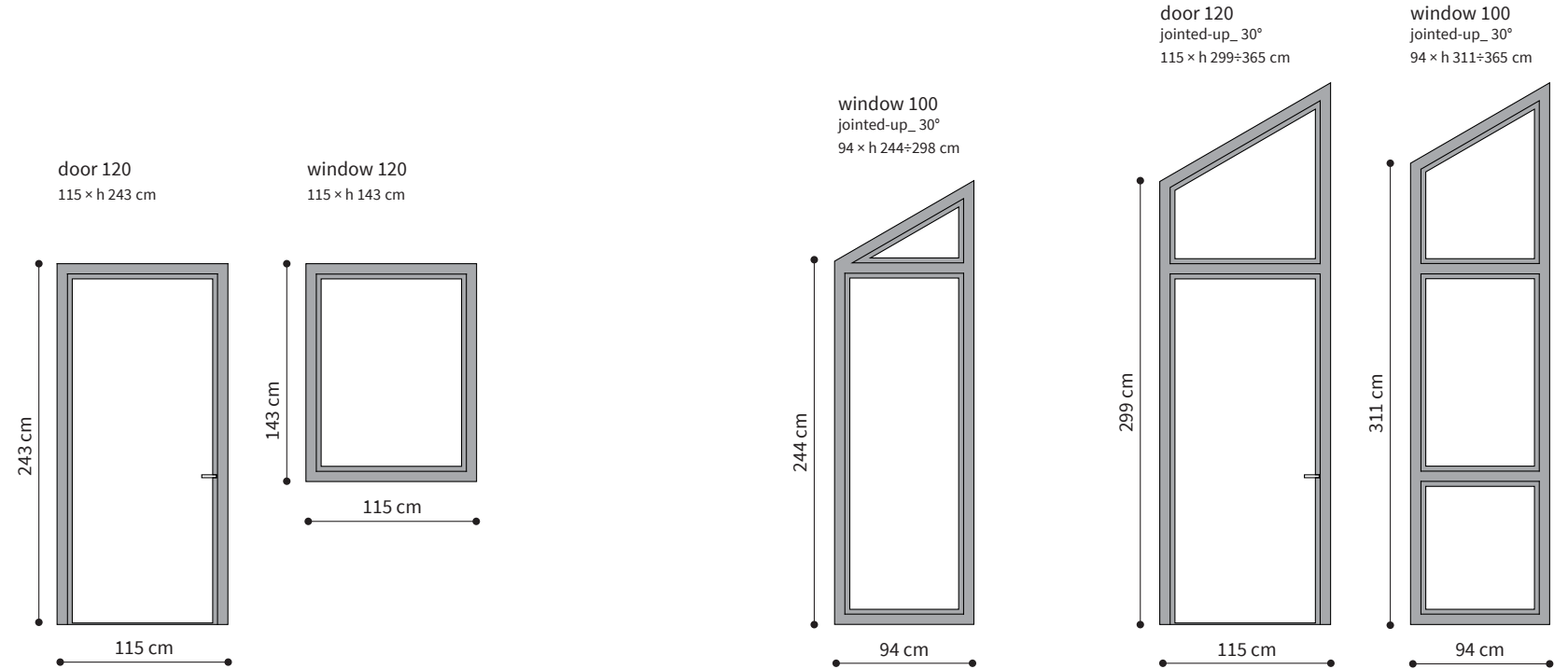

Figure 118/ Abacus of Archicart's panels and windows employable in a hut-scaped housing module



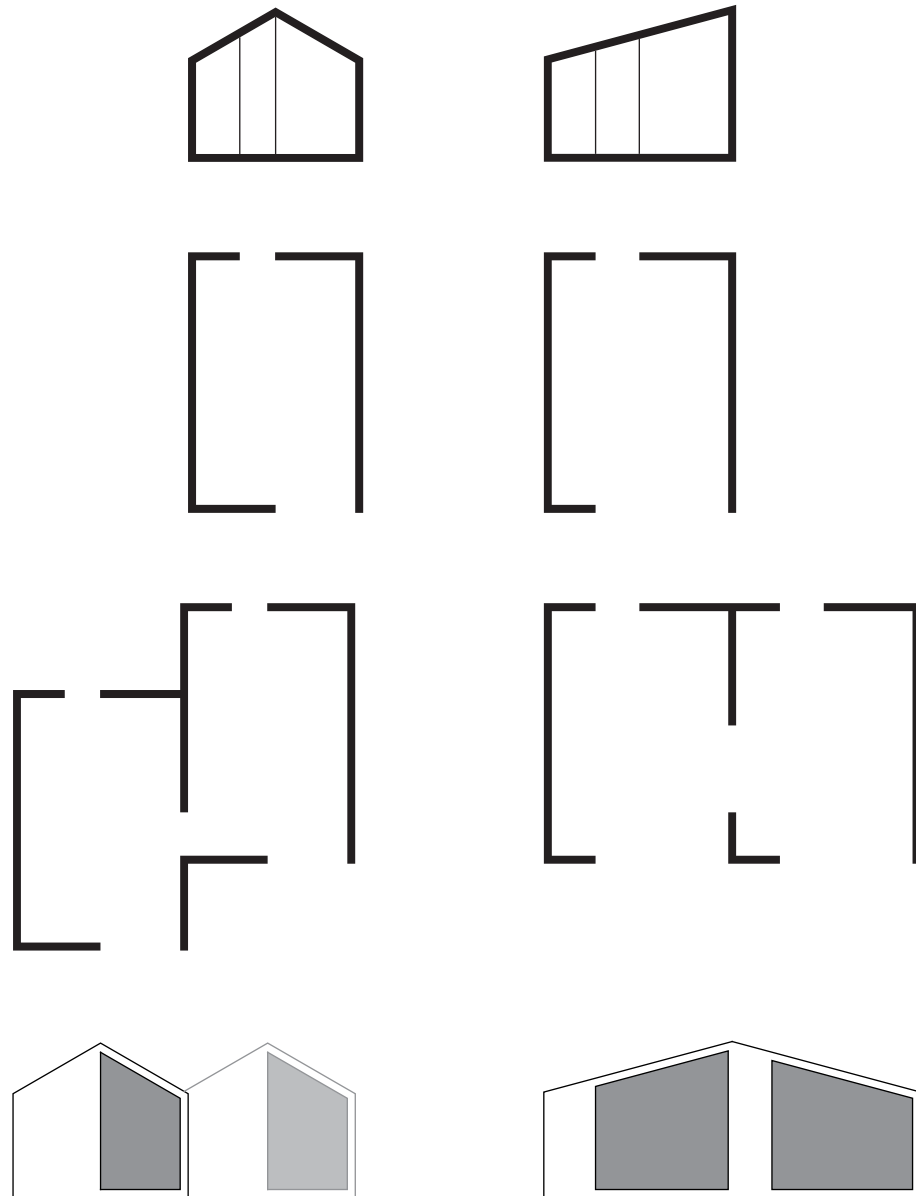

Figure 119 / Two examples of plan configurations: hut-shaped and mono-pitch-shaped sections

### *Plan configurations*

At building scale, it is preferable to deal with a restricted number of building shapes for a better integration in an emergency shelter area. A certain number of shelter types, called basic settlement units<sup>13</sup> (U.I.B.) mutually connectable, is a best practice to allow a rapid and efficient emergency response.

This objective is also achievable by providing a certain number of configurations of the same housing module, starting from a base one.

The types of plan configurations are conceived starting from the vertical section shape. There are two elevation shapes: hut and mono-pitch.

The longitudinal development of these two types of section generates the available area of the cardboard housing module:

- hut-shaped section: about 30m<sup>2</sup>
- mono-pitch-shaped section: about 35m<sup>2</sup>.

Starting from these two basic units, a certain number of configurations could be provided, e.g. doubling the starting units to obtain other two configurations, respectively of 60 and 70 m<sup>2</sup>.

### *Customizable aspects*

A housing module conceived to satisfy several needs of different kinds of families should be able to change according to singular needs, social assets and economic possibilities, by adapting to the actual socio-cultural contest.

The Archicart system allows to change the plan configuration during its usage period.

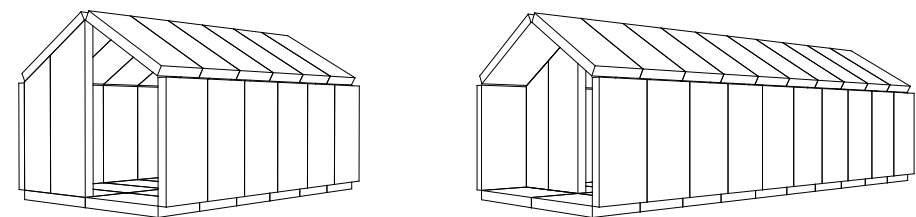

Figure 120 / Longitudinal expandability

This kind of shelters are provided in response to housing emergency and they could be occupied up to two years. During this period, the families' needs could change. E.g. a couple decides to have a child and they are occupying a basic unit for 1-2 persons. Thanks to the flexibility of Archicart construction system and to the adaptability of settlements, it is possible to expand the basic unit to obtain a larger one, according to actual family's needs.

### Sizing

#### *Personal space*

To evaluate the minimal extension of the cardboard housing module, the area per capita for each occupant is taken into account. The choice is to take the average value of available individual area between the container and the S.A.E.:

- Container 20 ft – about 8 m<sup>2</sup>
- S.A.E. 40 m<sup>2</sup> – about 20 m<sup>2</sup>
- Cardboard module – about 14 m<sup>2</sup>

Thus, a cardboard housing module destined to two persons should have a minimal extension of 28 m<sup>2</sup>, that corresponds to a volume of about 90 m<sup>3</sup>.

#### *Transportation*

Another aspect of dimensional definition is the relation between habitable volume and encumbrance volume of the unassembled house-kit module. The issue of transportation could deeply condition the final applicability of the solution.

To obtain the optimal compromise between inhabiting needs and transportation needs, it was developed a model of cargo operation based on the employ of ISO standard container 20 ft and standard pallet EURO 120×80 cm. The scope of the model is to evaluate the maximum loadable encumbrance volume in the minimum cargo units.

The optimization starts with the first attempt of packaging the overall

unassembled volume of a minimal cardboard house-kit, therefore sufficient at least for 1-2 persons.

The result of the modelling is that the load capability of 2 ISO 20 ft containers allows to ship 1 cardboard housing module of 30m<sup>2</sup> with the following components:

- n° 24 - PACO 120 h250 cm
- n° 12 - PACO 120 h220 cm
- n° 3 - PACO 120 h380 cm - 30°
- n° 4 - PACO 100 h320 cm - 30°
- n° 7 - PACO 90 h 240cm

Figure 121 / Load design of Container ISO 20 ft - Front view

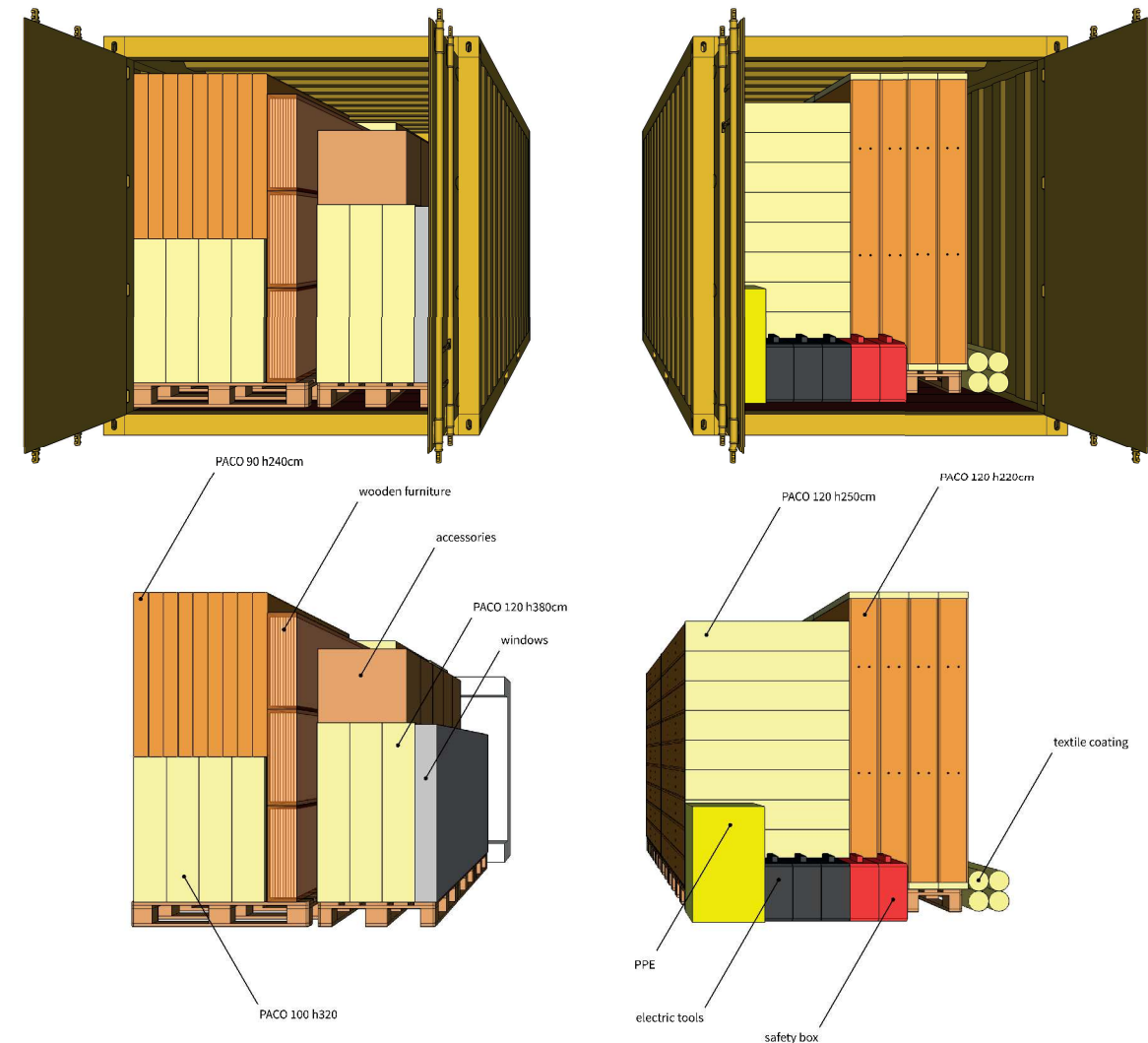

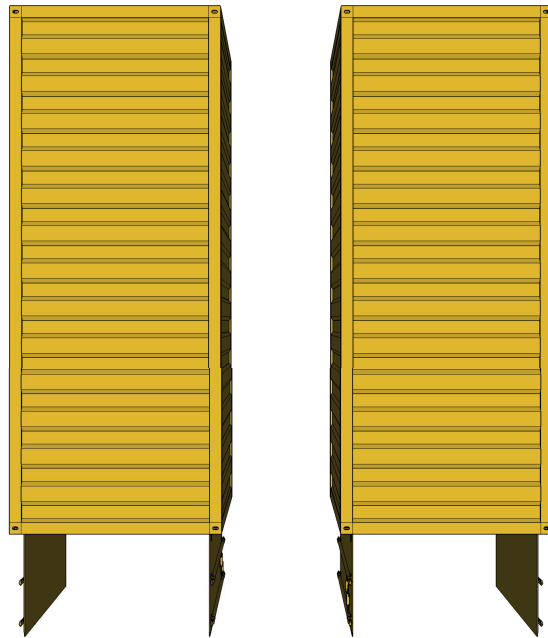

- n° 7 - PACO 90 for height compensation
- n° 10 - Foundation wooden beams
- n° 20 - Aluminium profiles
- textile coating
- vapour barrier and vapour stop

Figure 122 / ▲▼ Load design of Container ISO 20 ft - Top view

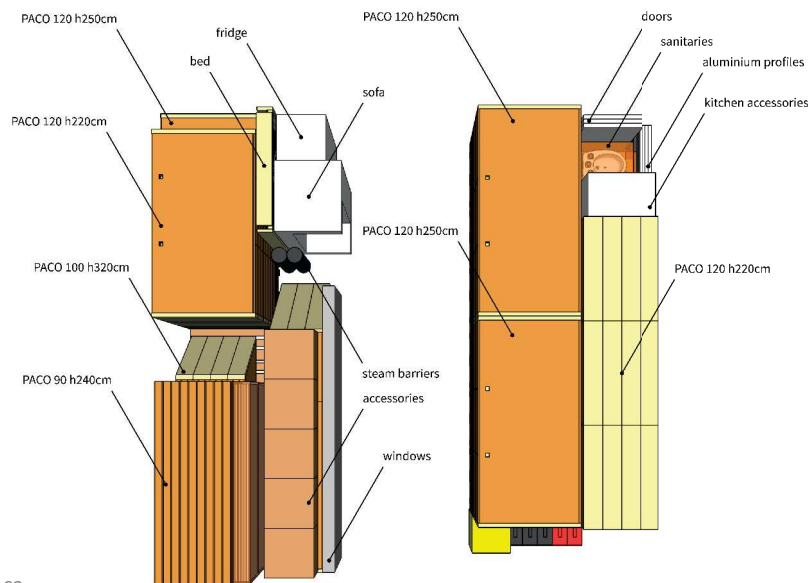

- assembly accessories (wooden joints, metal plates, systems, etc.)
- n° 2 Windows and n°3 internal doors
- bathroom accessories (bathroom fixture, shower, sink, etc.)
- house furniture (kitchen, laundry, bedroom, etc.)
- domestic appliances (fridge, wash machine, oven, hob, etc.)
- assembly tools
- Personal Protective Equipments - PPE.

The remaining space is not wasted, but it could give room to basic necessities.

Figure 123 / ▲ Load design of Container ISO 20 ft - Right view

Figure 124 / ▼ Load design of Container ISO 20 ft - Left view

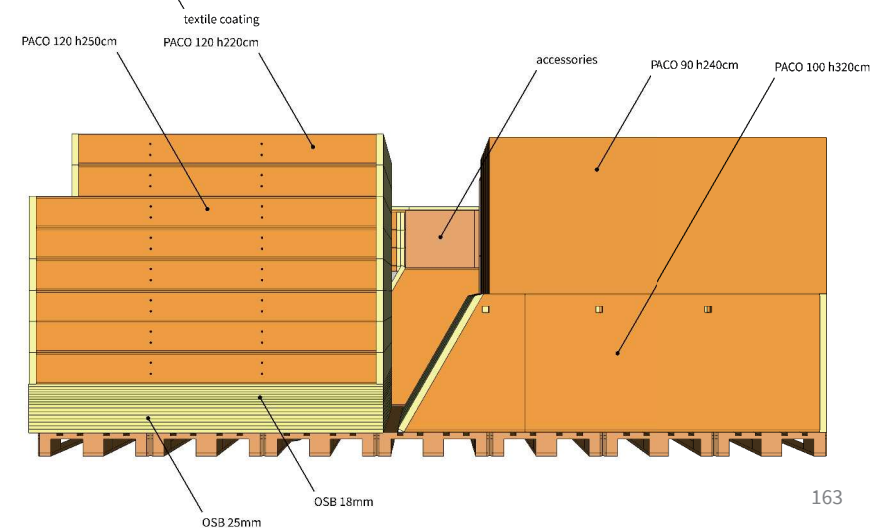
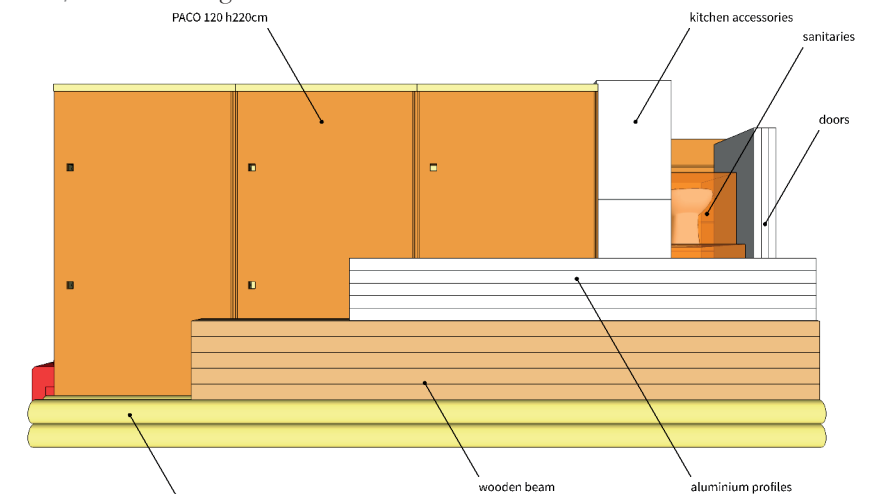

## 5.4 Architectural design

The outcome of the previous paragraph is the most effective sizing for a cardboard housing module destined to 1-2 persons. Starting from this boundary condition, it is possible to work with architectural design of the housing module according to modular features of this construction system.

### Plan distribution

Plan organization was developed starting from the individuation of functional spaces and their sq. m. needs.

Figure 125 / Examples of internal plan distribution of hut-shaped housing module

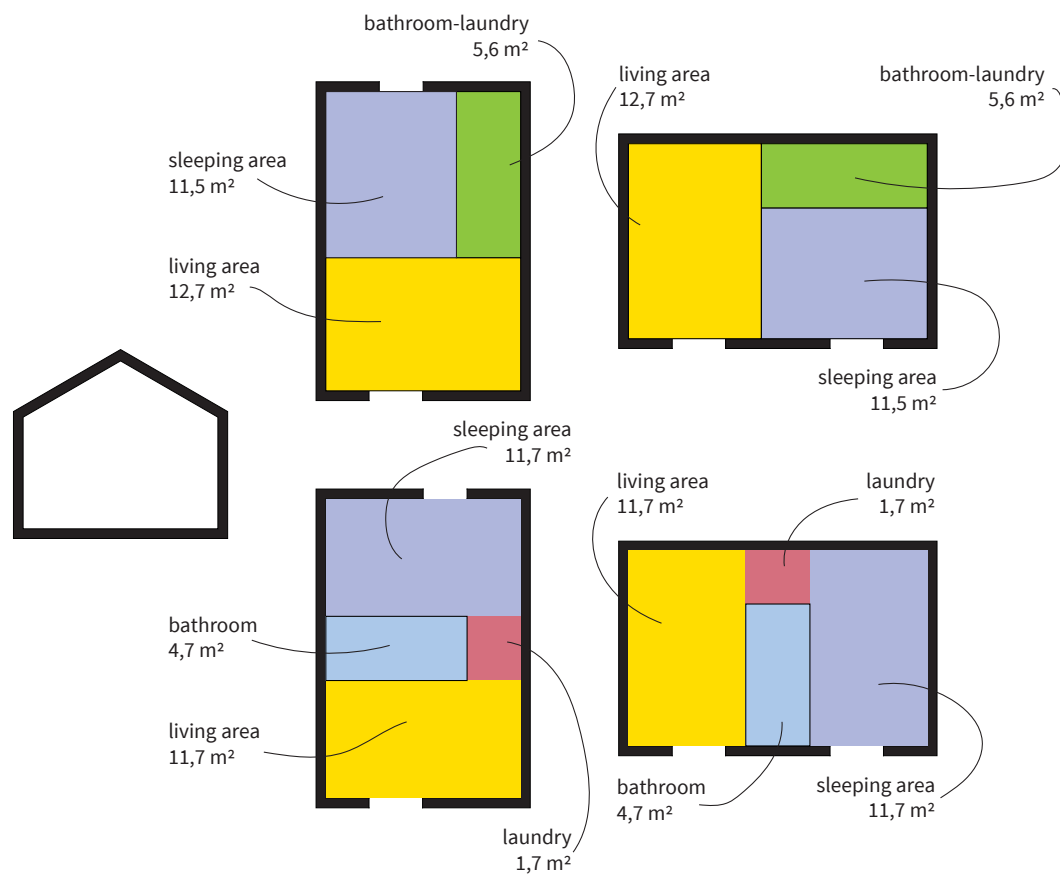

- Living area comprises cooking area, dining area and relaxation area. It should be at least of 10 m<sup>2</sup>.
- Sleeping area comprises bed and wardrobe. It should be at least of 9 m<sup>2</sup>.
- Bathroom area comprises toilet, bidet, shower, sink and laundry. It should be at least of 5 m<sup>2</sup>.

Two proposals were conceived on the base of hut-shaped housing module.

In the first case: the entrance opens in living area, where both the bedroom and the bathroom overlook. This solution allows to maximize the available area for living room, however, it concentrates all the services, bathroom and laundry, in the same room.

In the second case: the core of services works as fulcrum of the distribution, connecting living area with sleeping area, and acting also as laundry.

This solution reduces the living area in favour of services' separation and allows more privacy, thanks to the small corridor between the rooms.

### Openings, shadings and other components

In order to achieve the best passive behaviour, some architectural actions have been defined, in the list presented in paragraph 2, to be suitable for the cardboard housing module.

#### Openings

- Position – to allow natural cross ventilation, the openings are placed in opposite position in order to pull out heated air, thanks to pressure difference.
- Size – the openings are modular and integrated into the envelope of the cardboard shelter. The modularity allows to choose a certain number of frames to be set into the building, this number varies regionally according to daylight factors and balance of the solar gains and artificial lights employed. The sizing of openings is defined in the next paragraph 5.6

about parametric design.

- Types – transparent components are often the most difficult to afford for design process, but they can become strategic, if the air fluxes intervene.
  - Low-emission glasses matched with thermal-break frames are the basic devices for improving buildings' envelope performances.
  - Glass curtain wall together with Trombe Michel's wall allow to produce heated air flux in under-heated period and to avoid heating in overheated period.
  - Greenhouse is a device that allows to increase air temperature in a glass cabin during under-heated periods and to avoid the flux of heated air in overheated ones.

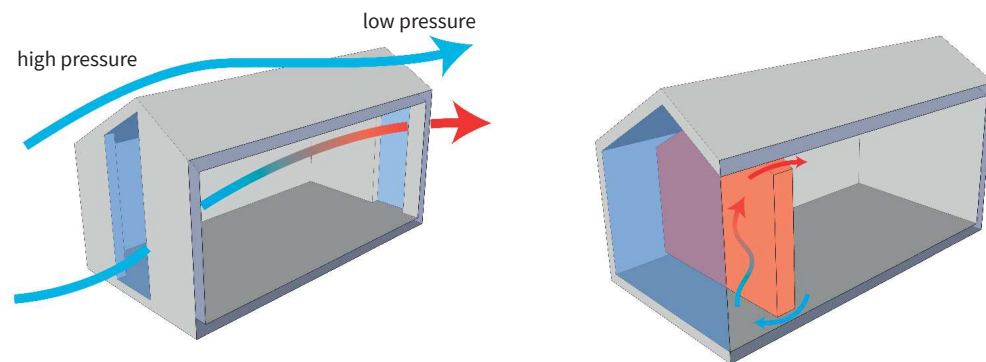

Figure 126 / ◀ Cross ventilation example of operation  
Figure 127 / ▶ Trombe Michel's wall example of operation

### Shadings

The transparent components of the building envelope should be protected by shading devices.

- Internal shading device – is the less effective, because when it starts to work, sun rays have already passed through glass, causing the overheating of the air gap between the device and the glass.
- External shading device – is more effective than the internal one,

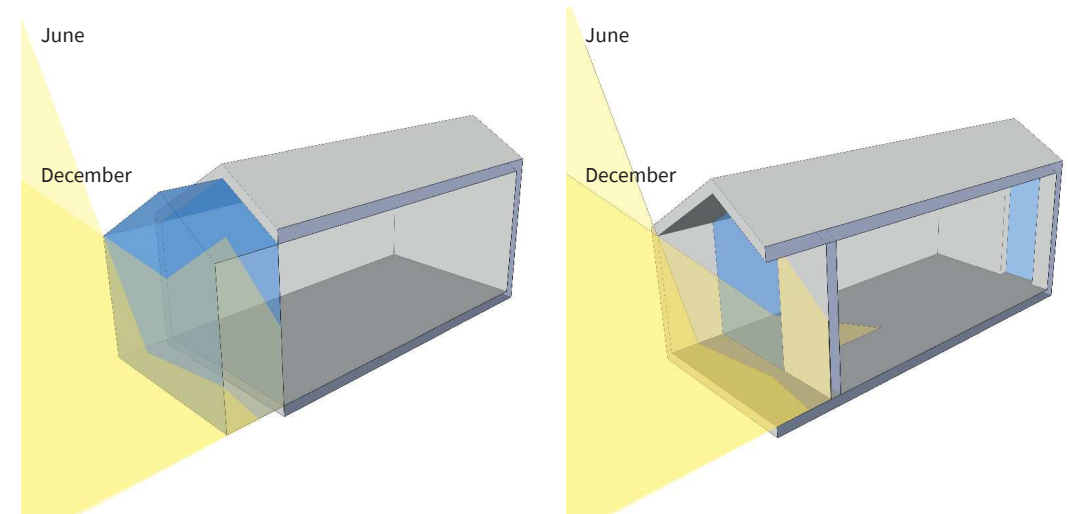

Figure 128 / ◀ Greenhouse example of operation  
Figure 129 / ▶ Projecting roof example of operation

because it blocks sun rays outside the building, but it is not friendly because of the necessity of action the device in entrance and in exit from the building.

- Projecting roof – is overall the best shading device. Opportunely sized, it allows to block sun rays in summer period and it allows to pass sun rays in winter.

### Stratigraphy

The opaque envelope contributes to the overall thermal performances of the building, according to several features of the component materials.

- Insulation materials – the alveolar corrugated cardboard panels are hollow to be filled with insulation materials, the optimal combination between density and thickness allows to achieve the optimal balance between insulation and thermal mass.
- Ventilated façade – the thermal regulation of the building envelope is guaranteed by employing an active ventilated façade. The active device permits air flux in the overheated period to reduce superficial temperature

and avoids air flux in under-heated period in order to maintain a static heated gap.

□ Ventilated ground connection – also the connection with the ground is ventilated through a foundation plank, which is spaced from the ground by means of punctual adjustable supports.

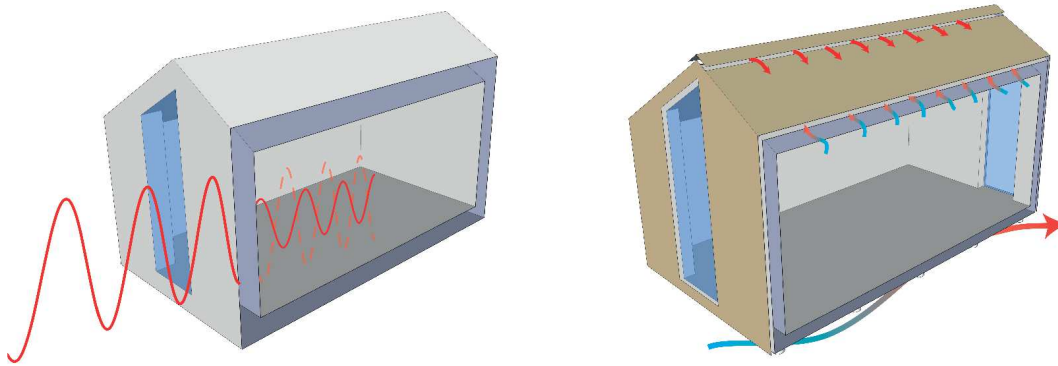

Figure 130 / ◀ Time lag and reduction of thermal wave due to thermal mass  
Figure 131 / ▶ Ventilated façade example of operation

## 5.5 Technical proposal

The cardboard housing module, as defined up to here, is a model of emergency shelter suitable for several climatic zones and socio-economic conditions thanks to its adaptable strategies and customizable options.

This paragraph presents the technical proposal of a housing module designed for the Mediterranean climate.

### *Building envelope*

The constructive principle of the housing module for Mediterranean climate is based on a double layer envelope, composed by an internal load-bearing structure and an external coating system.

The load-bearing structure is made of cardboard panels Archicart PACO, as described in the thermo-physical section in the chapter 4. It

was supposed to employ the standard panel with 22 cm of thickness and two different lengths 121,2 cm and 97,8 cm. This choice will be confirmed through the following parametric analysis.

The hut-shaped structure presents a load-bearing frame composed by two vertical panels and two sloped ones mutually connected through wood pentagonal joints, that allow 120° connections (corresponding to 30° sloping). The frame is also composed by two horizontal panels, less high than the other two types and jointed to them with rectangular-shaped wooden joints completing the structural asset.

For the external coating, it was decided to use a textile coating, that is maintained tensed by aluminium frames fixed on the cardboard internal layer. This second skin is spaced from the previous one by a gap of air of 8 cm.

### *Foundation*

The connection with the ground is solved by adopting a ventilated foundation wood frame. This framework is disposed under the horizontal panels and has the scope of distributing vertical loads exactly on adjustable supports. The foundation is completed by some concrete blocks that could be armed with Ø6 steel mesh, according to the resistance of the ground.

### *Openings*

The windows and doors present a wooden frame with thermal break completed by a low-emission double glass, filled by gas argon. The wooden frames are connected with PACO through plywood joints.

### *Technical systems*

The electric and hydraulic systems run through the floating floor and connect some cardboard panels for fixing switches and hydraulic points. The bathroom fixtures are connected with pipes that run under a counter wall.



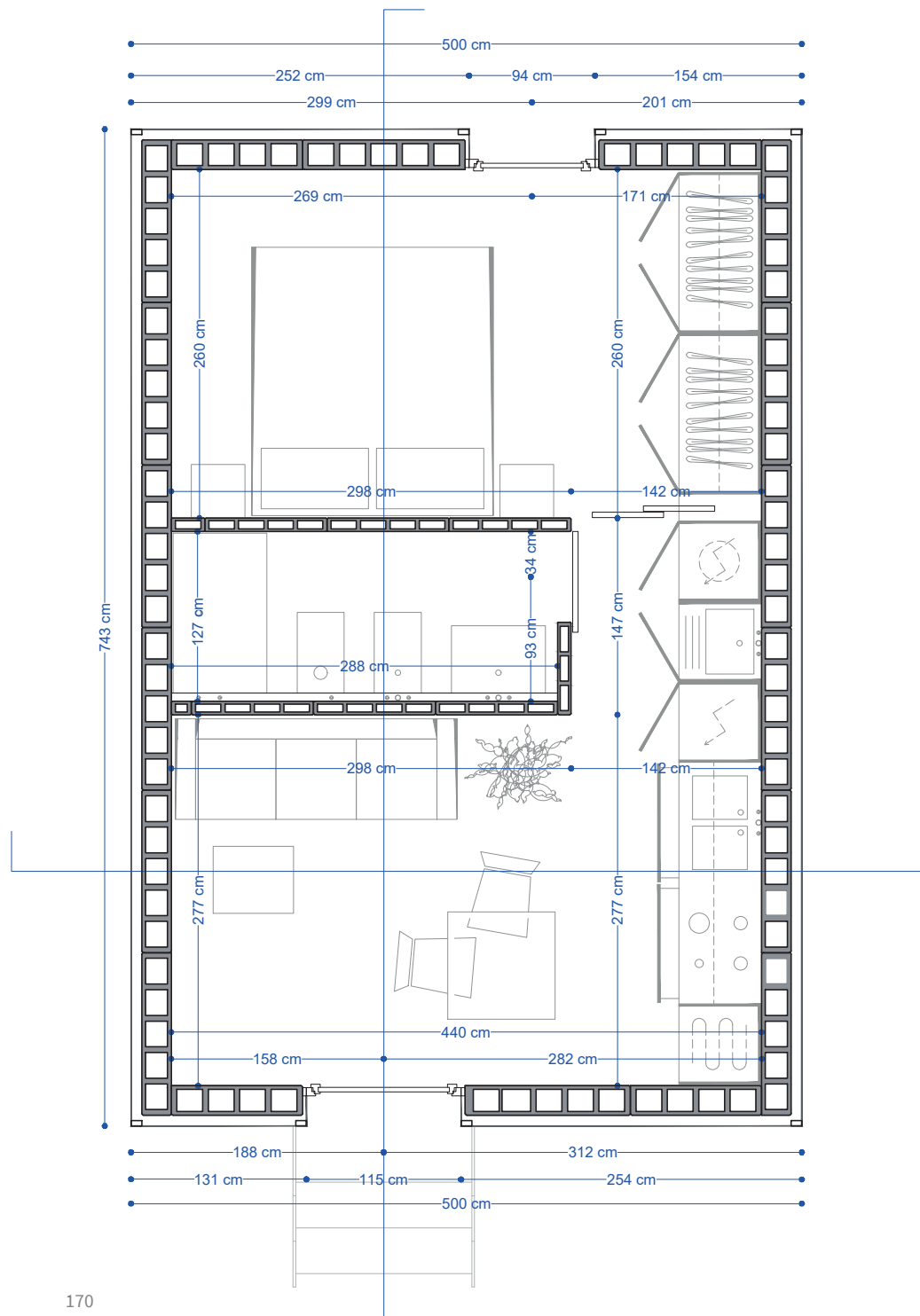
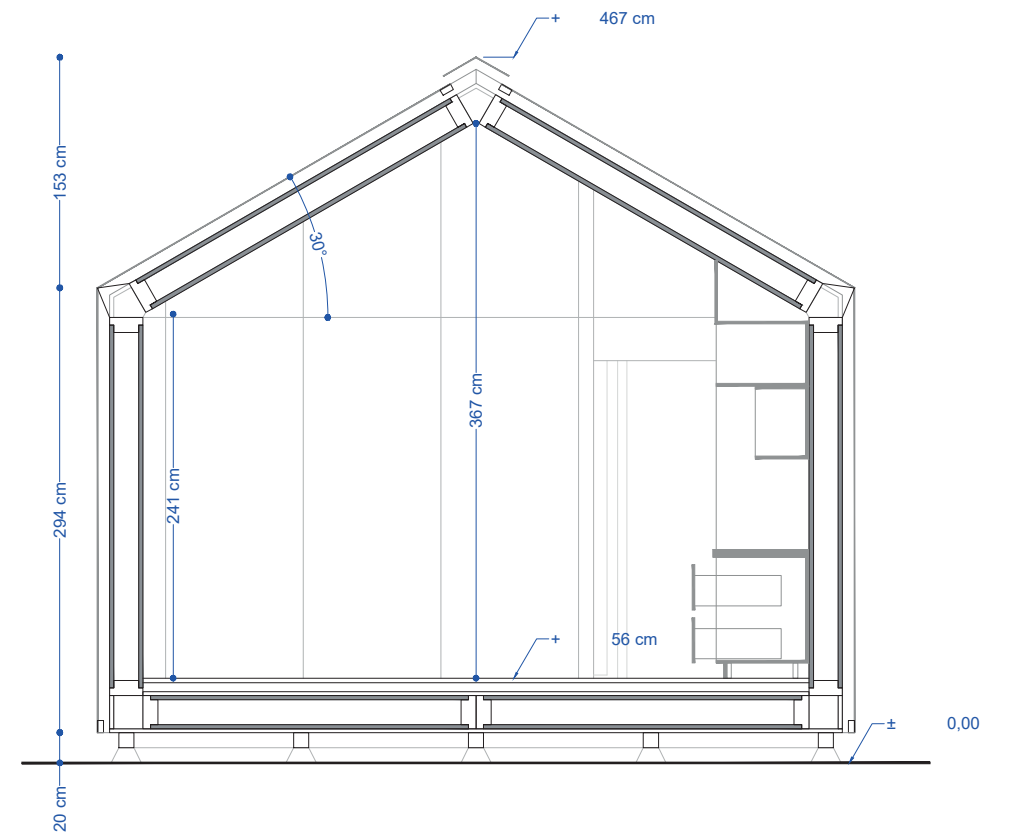

Figure 132 / ◀ Horizontal cross section - scale 1:50

Figure 133 / ▼ Vertical cross section - scale 1:50



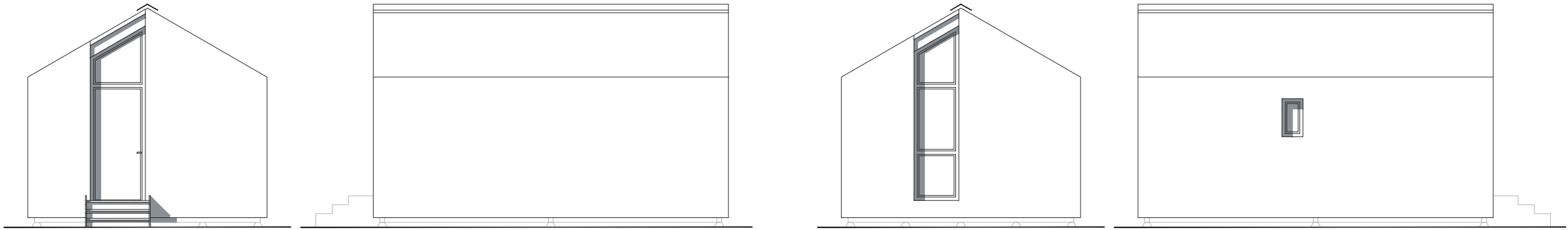

Figure 134 / ▲ Front views - scale 1:100  
Figure 135 / ▼ Top view - scale 1:100

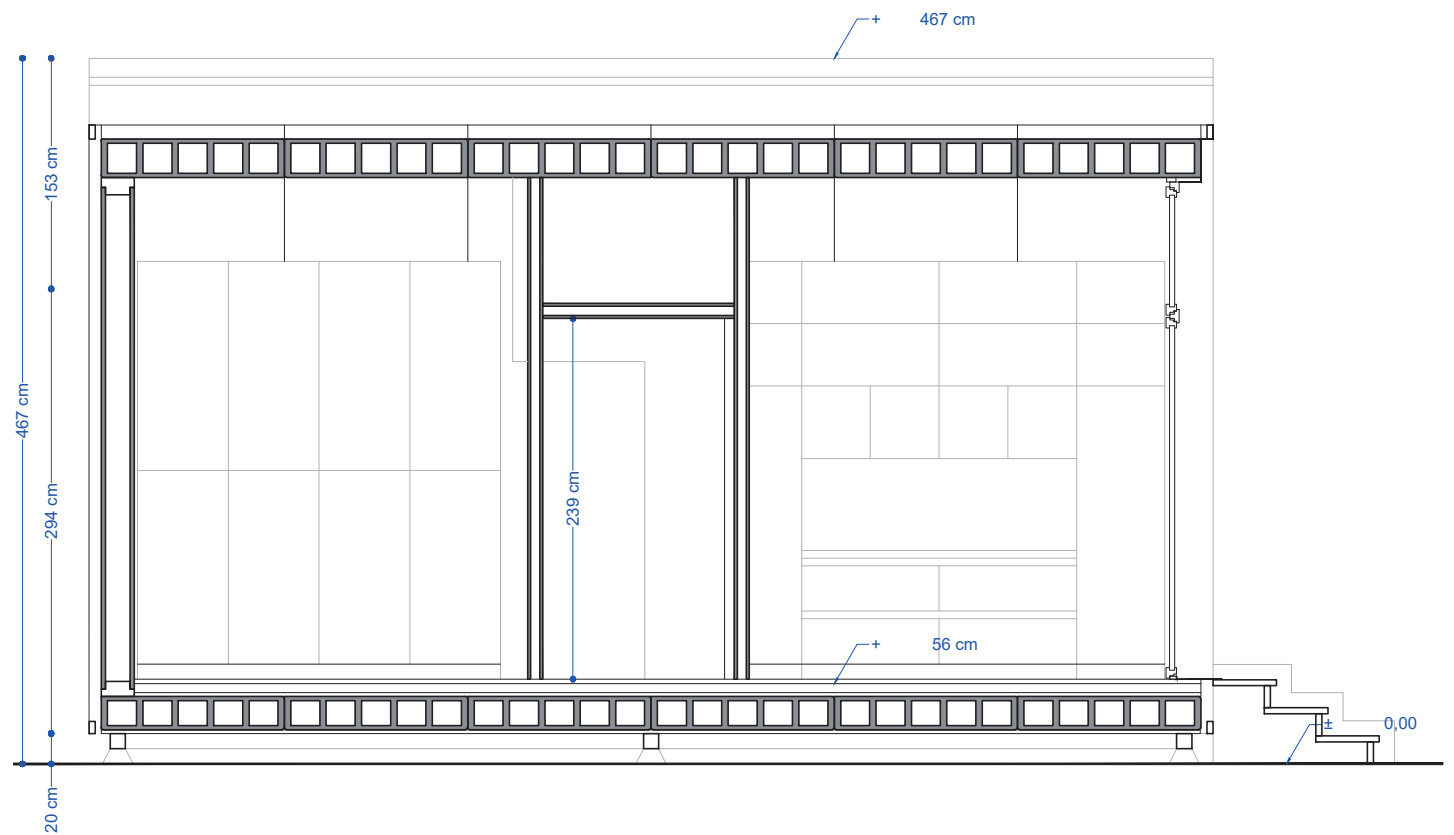
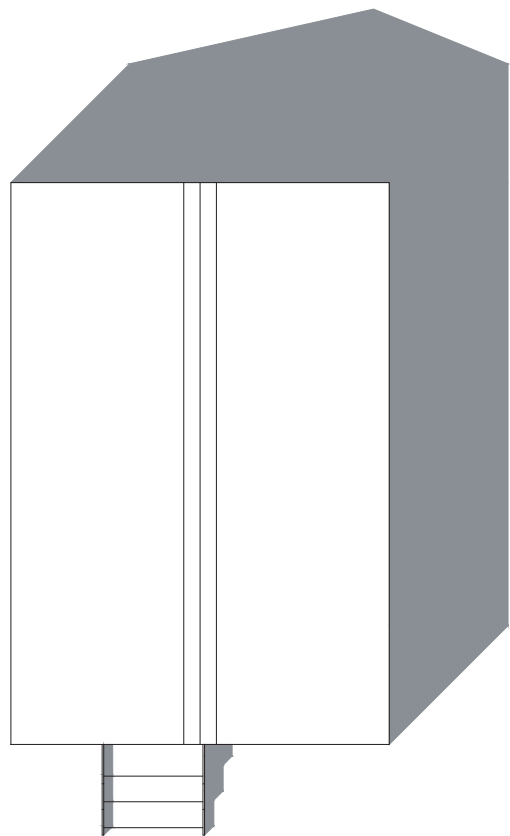
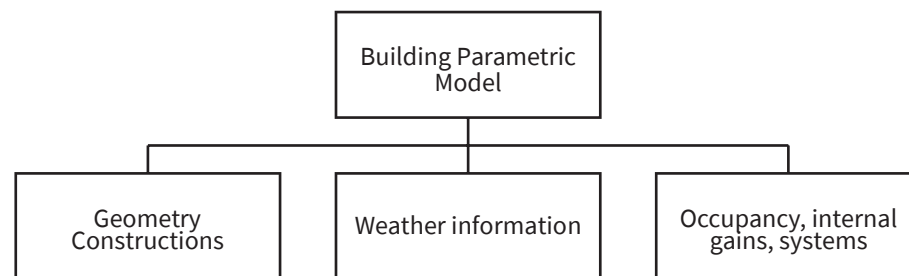

Figure 136 / Vertical cross section - scale 1:50

## 5.6 Parametric design

Once defined the technical design proposal for Mediterranean climate, it is possible to start with the dynamic simulations campaign, in order to verify and re-design forms, functions and qualities of each component of the building envelope.

The first step is to define the building parametric model according to the scheme below.



### Geometry – construction

- Thermal zones
- Opaque constructions
  - Conductivity
  - Specific Heat
  - Density
  - Surface properties
- Transparent constructions
  - Thermal properties
  - Solar properties
  - Visible properties
  - Infrared properties

### Weather information

- Location
  - Latitude

- Longitude
- Time zone
- Microclimate
  - Weather file
- Building orientation

### Occupancy internal gains, systems

- Activity
  - Occupancy
  - Environmental control (set point temperature, natural ventilatio)
  - Internal gains (equipment, lighting)
- Hvac
  - Heating
  - Cooling
  - Mechanical ventilation



Figure 137 / Ladybug and Honeybee logos - © Mostapha Sadeghipour Roudsari - via [www.food4rhino.com](http://www.food4rhino.com)

### Thermal zones

The individuation of thermal zones derives from the geometrical basic configuration of the cardboard housing module, as shown on the previous paragraph.

The CAD software *Rhinoceros* allows to design the gross volume of the three different areas: living room, bedroom and bathroom. This operation is the last one in *Rhinoceros*, because, from this point on, the programming with the graphic algorithmic editor *Grasshopper 3D* (completed by its plugins *Ladybug* and *Honeybee*) starts.

After the acquisition of *BREP* geometry on the GH's canvas, it begins the definition of closed thermal zones through some Honeybee's commands that allow to convert solid geometries into interpretable thermal zones, solving conflicts between adjacent zones, and giving properties to surfaces.

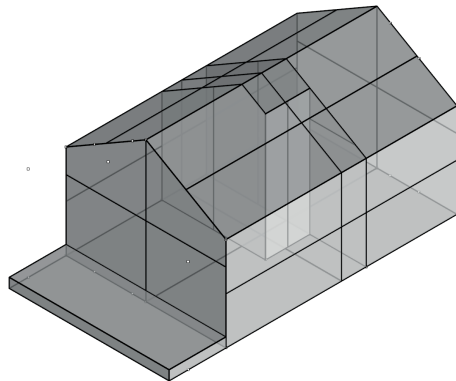

Figure 138 / Honeybee Intersect Masses

### Openings

The sizing of openings is the passive strategy that allows to intercept the solar heating in cold periods and avoid it in hot one. For this reason, it was programmed a parametric model of glazing external windows and doors, based on the same module of the Archicart PACOs.

Standard openings net sizes for E-W fronts:

- $115 \times h 243$  cm
- $115 \times h 143$  cm

Off-standard opening on W front:

- $44 \times h 80$  cm

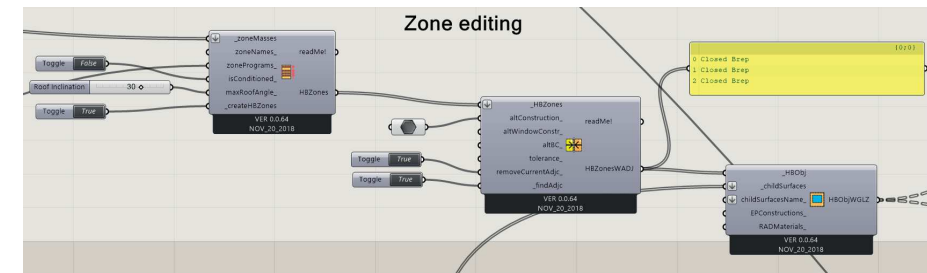
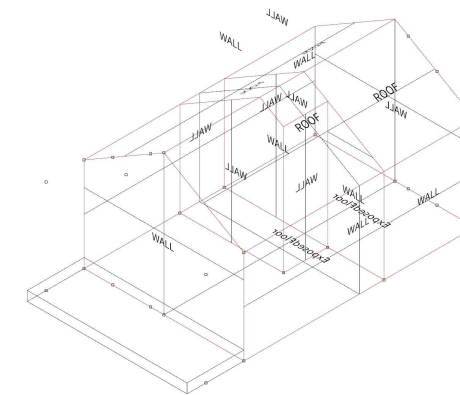

Figure 139 / Sequence: HB Masses to Zones - HB Solve Adjacienses - HB add Glazing

Standard openings net sizes for N-S fronts:

- $115 \times h 299 \div 365$  cm
- $94 \times h 244 \div 298$  cm
- $94 \times h 311 \div 365$  cm

For the simulation in Mediterranean climate it has been chosen the standard N-S apertures.

The gross widths of the openings are defined with the item *Value list* that comprises 4 elements:

- none (corresponds to no windows)
- 98 cm
- 120 cm
- 220 cm

Other two items *Value list* are added in the canvas to get the final height of the window, calculating the value of offset from the bottom and from the top of the boundaries of the model.

- Bottom value list
  - Min (30 cm – corresponds to the quote of the floor)
  - Max (100 cm – corresponds to the standard height of window)
- Top value list
  - Max (410 cm)
  - 300 cm

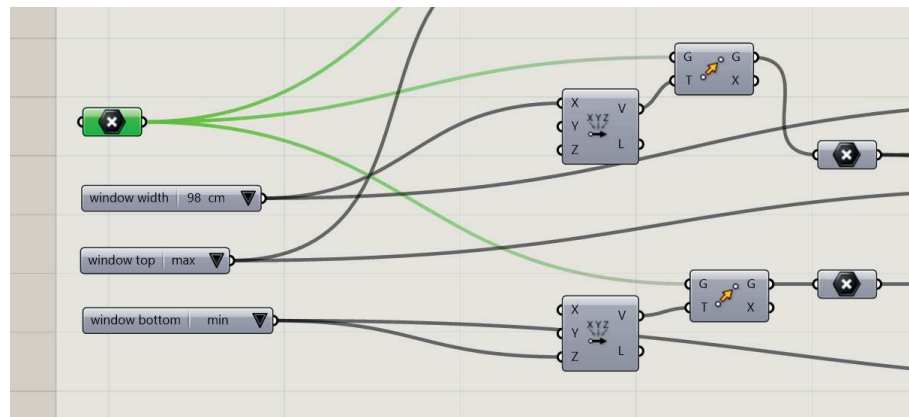

Starting setting the middle point of the South front and North one, it can be calculated the position of each other point of the window surface through simple *Maths* items and thus *Transform* and *Surface* ones.

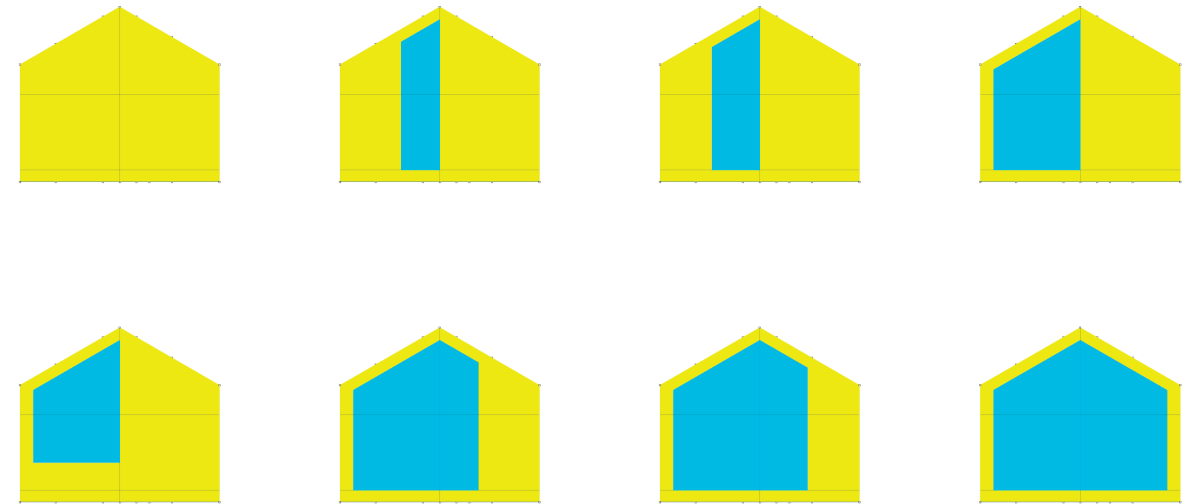
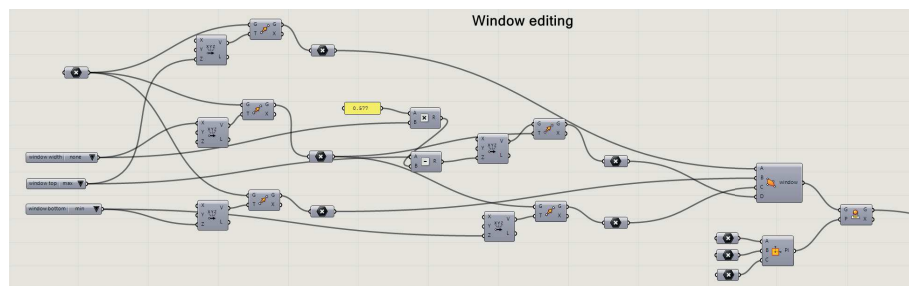

Figure 140 / Custom Preview of 8 of 24 openings possibilities

Figure 141 / ◀ Sequences of GH Math, GH Transform and GH Surface commands

This windows parametric model is based on 4 identical algorithms that generate 4 openings model. Each opening model allows 6 possible combinations of standard windows and 65 possibilities for doors. The 6 combinations for 4 algorithms allows 24 overall standard opening possibilities. A customized Preview helps to display the results.

### Shadings

Shading systems are the most effective devices for controlling solar gains. The choice for Mediterranean climate is to employ a projecting roof device that can change its projection seasonally, according to sun rays' inclination.

The parametric model of this kind of device is obtained starting from the definition of three projection roof sizes related to seasons:

- 60 cm – winter
- 120 cm – spring/autumn
- 180 cm – summer.

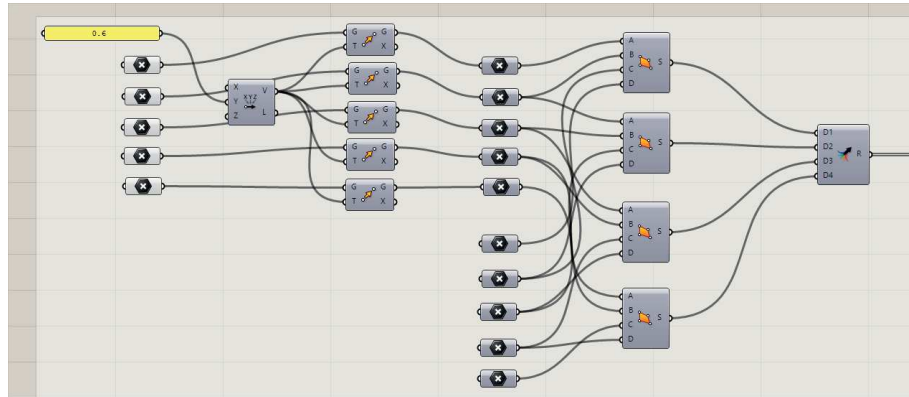

Figure 142 / Sequences of GH Math, GH Transform and GH Surface commands to build the parametric surfaces needed for define openings

The model takes from Rhino’s *viewport* five points that trace the hut-shape of the shading devices. Through *Maths* and *Transform* commands five others offset points, that are related to the projection size, are individuated. Thus, the 4point surface command composes the shading surfaces.

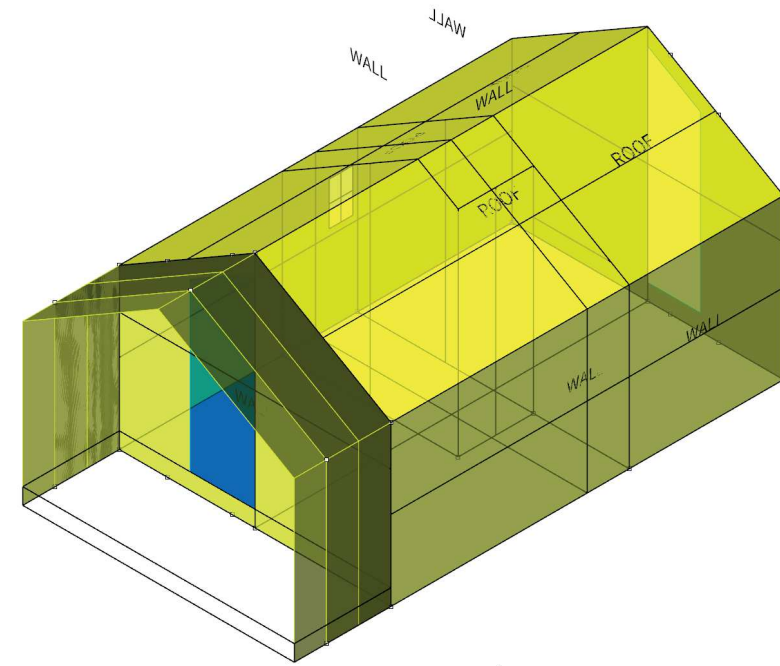

Figure 144 / Custom Preview of Shading system

The yearly variations of shading projection sizes are programmed by a *Schedule* command that outputs 1 and 0 value respectively for enabling or disabling each roof projection, according to the seasons. E.g. the scheduling of winter period enables 60 cm projection roof from December to March.

**Opaque constructions**

The cardboard housing module has a unique material stratigraphy characterized by the ground-breaking technology of alveolar corrugated cardboard panels. For this reason, the envelope stratigraphy must be programmed layer by layer through the command *EP opaque material* and then assembly by the command *EP construction*. The table refers to the three types of opaque constructions’ stratigraphy present in the model.

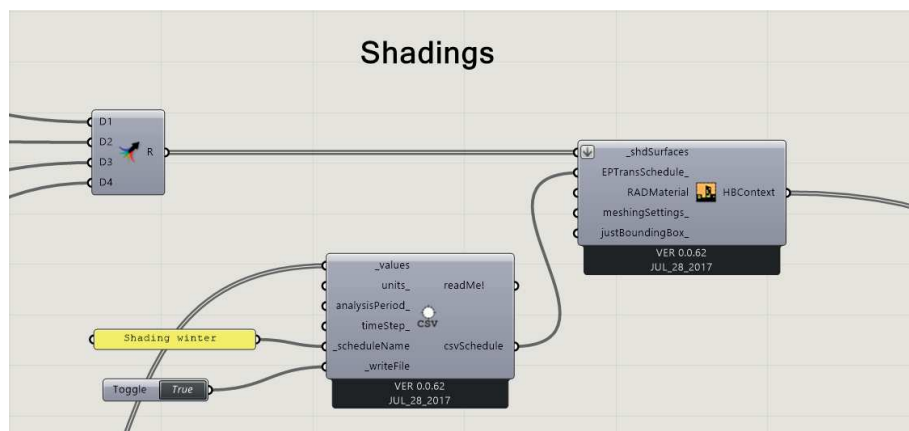

Figure 143 / Schedule programme of seasonal projection depth and consequent definition of HB EnergyPlus Context surfaces

Description	Roughness	Thickness [cm]	Conductivity [W/m K]	Density [kg/m <sup>3</sup> ]	Specific heat [kJ/kg K]	Solar absorption	Fonts
<b>PACO wall</b>							
PVC textile	Very Smooth	0,043	0,14	1.325	1.000	0,27	productor
Air gap	Smooth	8	0,51	1,3	1.000	na	Doe2 Ashrae
Corrugated cardboard	Rough	2,8	0,065	110	1.300	na	CTI 1980
Cellulose fibre	Medium Rough	16,2	0,037	30	1.380	na	productor, Doe2 Ashrae
Corrugated cardboard	Rough	2,8	0,065	110	1.300	na	CTI 1980

Table 17/ Features of PACO wall construction material

Description	Roughness	Thickness [cm]	Conductivity [W/m K]	Density [kg/m <sup>3</sup> ]	Specific heat [kJ/kg K]	Solar absorption	Fonts
<b>PACO floor</b>							
OSB	Rough	2,5	0,0915	650	1.880	na	Ashrae
Corrugated cardboard	Rough	2,8	0,065	110	1.300	na	CTI 1980
Cellulose fibre	Medium Rough	16,2	0,037	30	1.380	na	productor, Doe2 Ashrae
Corrugated cardboard	Rough	2,8	0,065	110	1.300	na	CTI 1980
OSB	Rough	1,8	0,0915	650	1.880	na	Ashrae

Table 18/ Features of PACO floor construction material

Description	Roughness	Thickness [cm]	Conductivity [W/m K]	Density [kg/m <sup>3</sup> ]	Specific heat [kJ/kg K]	Solar absorption	Fonts
<b>PACO partition</b>							
Corrugated cardboard	Rough	2	0,065	110	1.300	na	CTI 1980
Air gap	Smooth	8	0,51	1,3	1.000	na	Doe2 Ashrae
Corrugated cardboard	Rough	2	0,065	110	1.300	na	CTI 1980

Table 19/ Features of PACO partition construction material

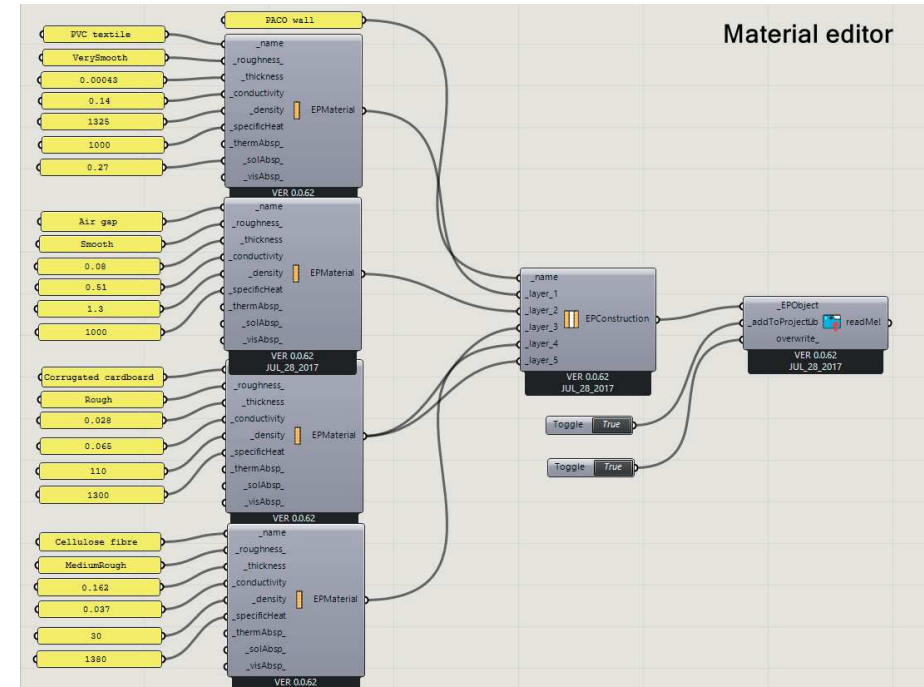

Figure 145 / ▲ Sequence of definition of construction stratigraphy: HB EnergyPlus Opaque Material - EP Construction - HB add to EnergyPlus Library  
 Figure 146 / ▼ Sequence of definition of window material: HB EnergyPlus Window Material - EP Construction - HB add to EnergyPlus Library

**Transparent constructions**

The cardboard housing module presents windows and doors made up of wooden frame and double low-emissions glasses with the following features:

$$U_{\text{frame}} = 1,3 \text{ W/m}^2 \text{ K}$$

$$U_{\text{glass}} = 1,0 \text{ W/m}^2 \text{ K}$$

$$U_{\text{window}} = 1,23 \text{ W/m}^2 \text{ K}$$

The *EP window material* command allows to add the customized transparent construction material to the library of the project.

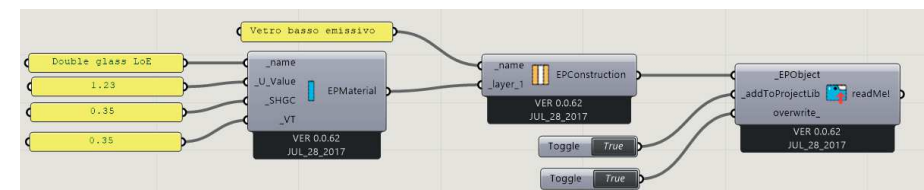

### Location

The aim of realizing a full-scale prototype, which allows to verify the parametric model and the technologic proposal, led to define the simulation programme of the cardboard housing module on the Mediterranean climate of Catania (Sicily, Italy).

### Weather file

A weather file is a text document provided in EnergyPlus Weather Format (EPW). This kind of weather data file contains hourly weather parameters of a year.

EPW is referred in the GH's canvas through the command *import EPW*.

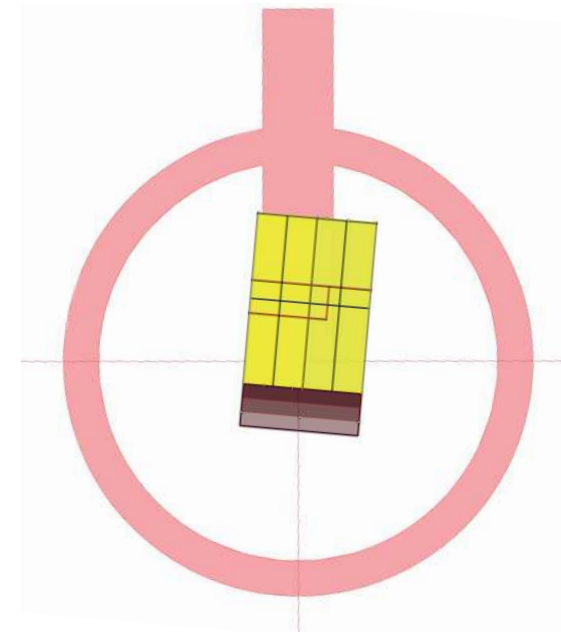
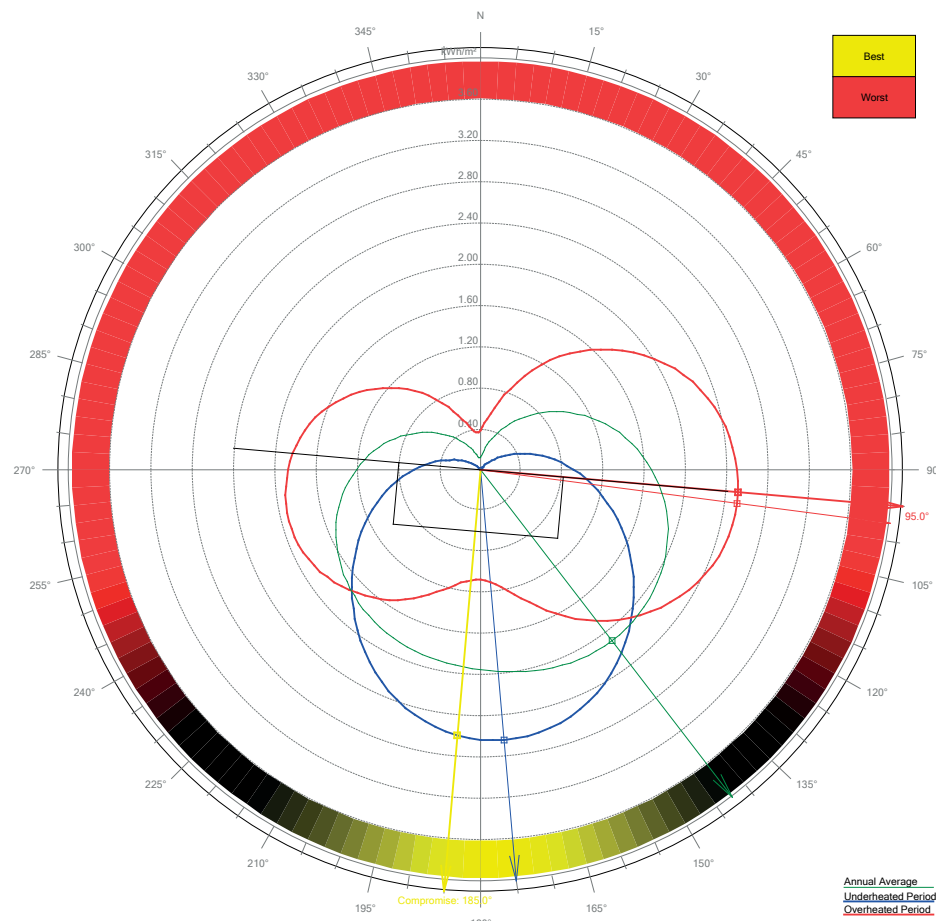

Figure 147 / ▲ Ladybug North

Figure 148 / ◀ ECOTech Weather Tool - Location Catania, Sicily, Italy

### Building orientation

The choice of the best building orientation is the result of an analysis that balances the benefits of solar gains on cold period and the downsides on the hot one. This kind of analysis takes into account both solar radiations and wind directions to evaluate the best and the worst angle of rotation in relation to the north axis.

A good approximation is offered by *ECOTect Analysis* that generates, from weather file, a proposal of orientation angles useful for the preliminary positioning.

The optimum orientation, evaluated by the *Weather Tool* for ECOTect, is of 5 degrees from the North axis.

In the next phase the North direction is changed, on GH's canvas, through *real North* item.



## Occupancy

The parametric design is based on dynamic simulations, which need the definition of the kind of activities played inside the building to evaluate both the internal gains and the comfort requirements.

The type of occupancy is configurable by the item *Building programme* that presents several kinds of occupancy:

- Office
- Retail
- Midrise Apartment
- Primary School
- Secondary School
- Small Hotel
- Large Hotel
- Hospital
- Outpatient
- Warehouse
- Supermarket
- Full-service Restaurant
- Quick-service Restaurant

The emergency housing module is destined to residential occupancy that corresponds to *Honeybee Midrise Apartment*, which comprises:

- Apartment
- Office
- Corridor

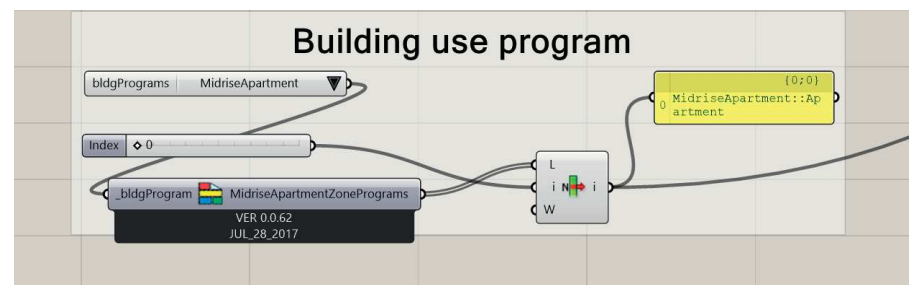

Figure 149 / Honeybee List Zone Programs

A *list item* allows to choose the apartment setting.

In addition to define the kind of occupancy, a schedule of weekly occupancy, in hours, is programmable as follows:

5 weekdays, occupancy hours: 1:00 – 8:00 / 13:00 / 17:00 – 24:00, for a total of 17h

2 holidays, occupancy hours: 1:00 – 24:00, for a total of 24h.

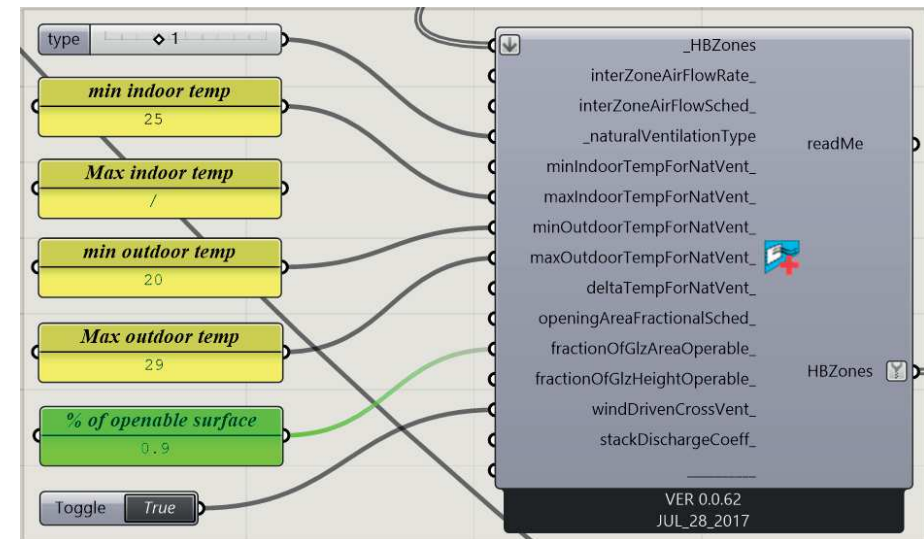

Figure 150 / Natural ventilation component: Honeybee Set EnergyPlus Air flow

## Environmental controls

In order to evaluate passive building performances, the setup of the building for dynamic simulation is free running, i.e. without any kinds of HVAC systems (Heat Ventilation and Air Conditioning). Instead of HVAC, Honeybee offers several commands for programming passive strategies.

Natural ventilation is a Honeybee item that provides a programme of airflow, based on temperature-set points.

The natural ventilation of the cardboard shelter is provided by all of the openings. They are almost entirely openable, except for the frame thickness. The values of required parameters are listed below:

- type of ventilation: natural ventilation without mechanical systems
- min indoor temperature: 25°C
- max indoor temperature: /
- min outdoor temperature: 20°C
- max outdoor temperature: 28°C
- percentage of openable apertures: 90%.

**Run simulations**

The scope of this phase of the research is to find the best balance of design factors according to lighting and thermal performance. To reach this scope, Daylight simulation and Energy Plus simulation allow to find the perfect match between natural lighting needs, natural ventilation and solar gains.

This match determinates optimum values of opening sizes and shading system projections.

The comparison involves the following realistic combinations of opening sizes and shading projections for Mediterranean climate.

	code	South openings	North openings	Shading system
1	SsNsSn	94 cm	94 cm	none
2	SsNsSs	94 cm	94 cm	scheduled
3	SmNsSn	115 cm	94 cm	none
4	SmNsSs	115 cm	94 cm	scheduled
5	SINmSn	220 cm	115 cm	none
6	SINmSs	220 cm	115 cm	scheduled

Table 20/ Combinations of openings sizes and shading system

**Daylight simulation**

The *Honeybee Annual daylight simulation* produces a map of test points corresponding to the internal floor area. Each point of the map registers the quantity of direct and indirect solar ray incidence and its relative illuminance.

An output of daylight annual illuminance simulation is *Daylight Autonomy* that represents the percentage of time, during the occupancy hours. As parameter it is assumed that the test point receives more daylight than the illuminance threshold of 300lux. The opposite of DA is *Continuous Daylight Autonomy* (percentage of time in which the test point receives less daylight than 300lux), that is useful to evaluate the total need of artificial lighting during a year of a daily-period occupancy.

Another useful simulation tool is *Daylight factor simulation* that evaluates the daylight factors of each test point of a test map.

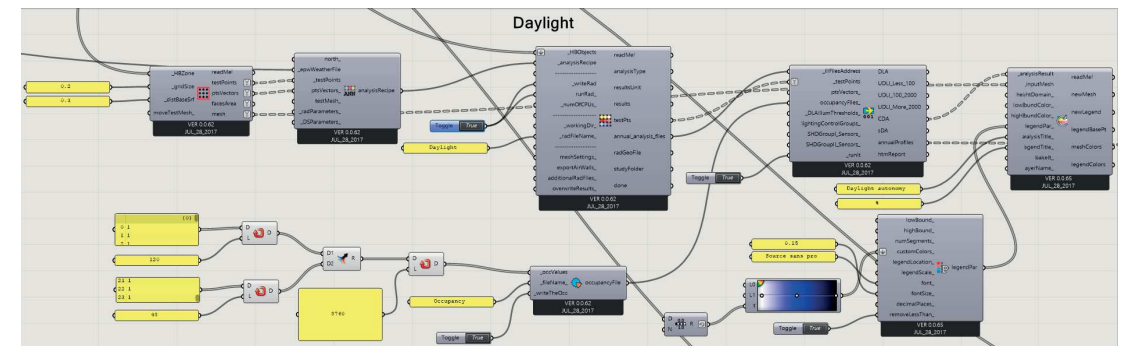

Figure 151 / Sequence: HB Annual Daylight Simulation - HB Run Daylight simulation - HB Daylight Autonomy

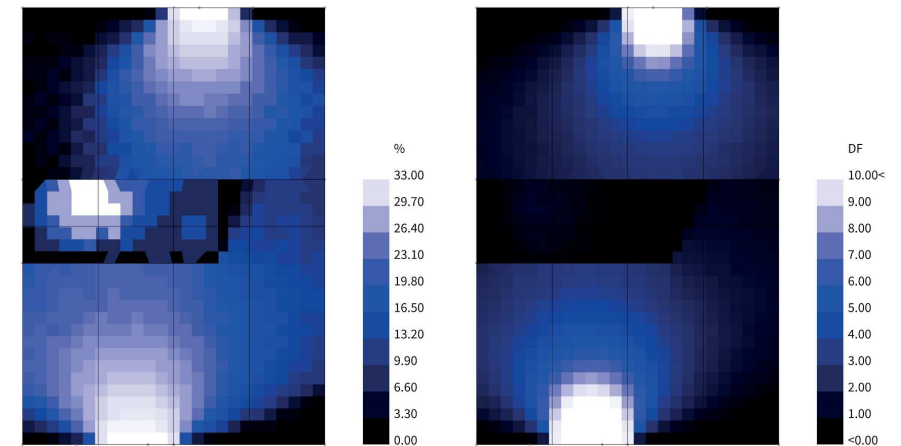

Figure 152 / Output of simulation SmNsSn: ◀ Daylight autonomy: percentage of hours of illuminance > than 300lux; ▶ Daylight factor

### Energy simulation

The *Honeybee Run energy simulation* has got EnergyPlus core engine that generates thermal analysis of each thermal zone.

The energy simulation produces a list of output data, useful to evaluate interesting parameters of design:

- electric energy needs (for lighting and equipment)
- occupancy gains
- solar gains
- infiltrations energy
- natural ventilation energy
- operative temperature
- air temperature
- mean radiant temperature
- relative humidity.

The main outcomes of energy simulation are the parameters involved in thermal comfort evaluation.

The quantities that influence the thermo-hygrometric comfort of an individual in a given environment are 6, 4 of them are environmental and 2 individual.

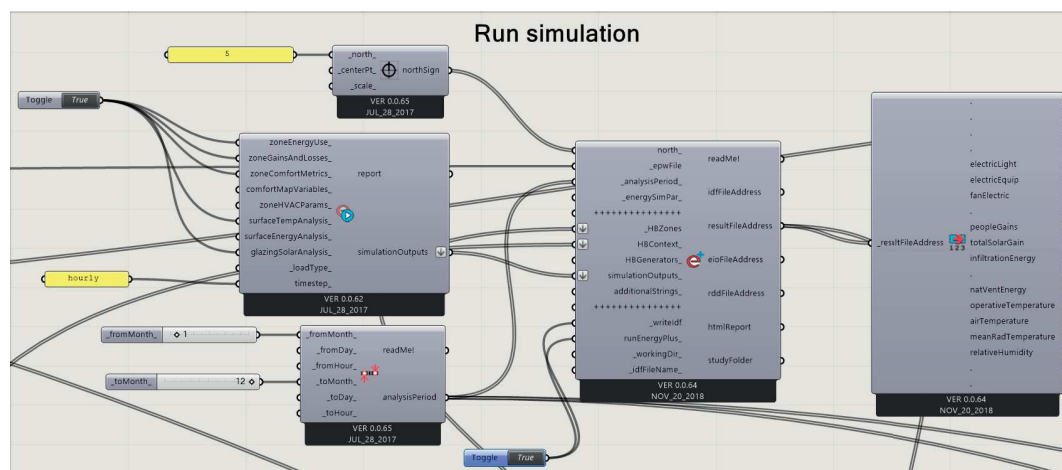

Figure 153 / Honeybee Run Energy Simulation sequence

- The 4 environmental are:
  - air temperature;
  - mean radiant temperature
  - air speed
  - relative humidity.
- The 2 individuals are:
  - activity level (metabolism)
  - clothing.

The component *Honeybee PMV comfort calculator* is based on thermal comfort model of P. O. Fanger, which takes into account other 2 factors that influence the perceived comfort condition: the skin temperature, and the heat loss, through sweating, during the phase of metabolism.

This component will output the PMV of the occupants for the input conditions, as well as an estimate of the Percentage of People Dissatisfied (PPD) under those given conditions. PPD refers to the percentage of people that would give to PMV a score greater than/equal to 1 or less than/equal to -1.

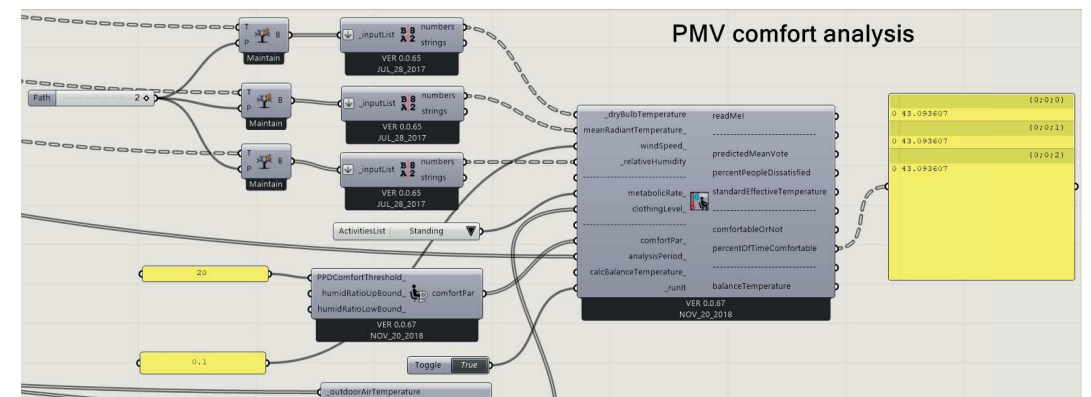

Figure 154 / Honeybee PMV comfort calculator

The *Ladybug Psychrometric chart* command allows to preview the PMV comfort area. The input data will be plotted on the chart alongside polygons on the chart, representing comfort, as well as polygons, representing the effects of passive building strategies on comfort.

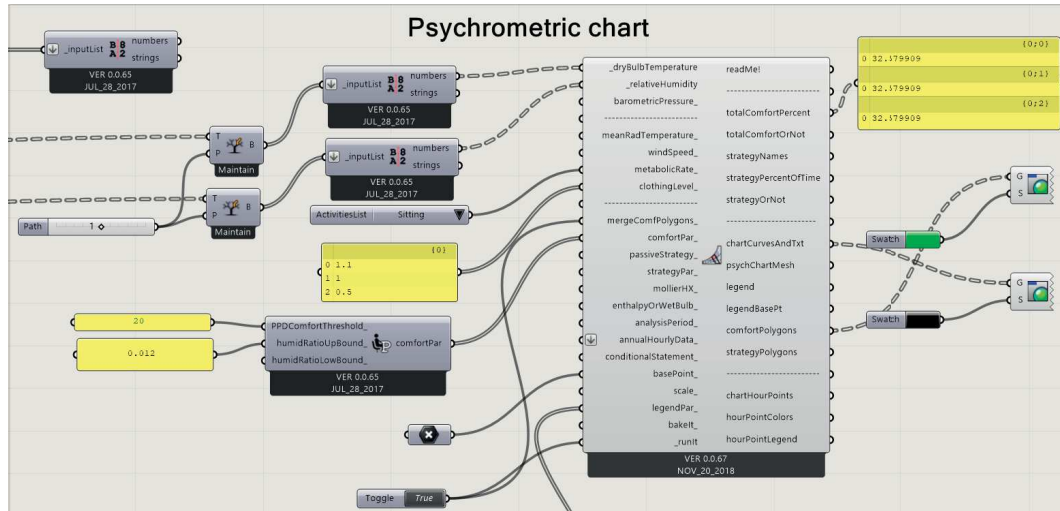

Figure 155 / Ladybug Psychrometric chart  
Psychrometric Chart

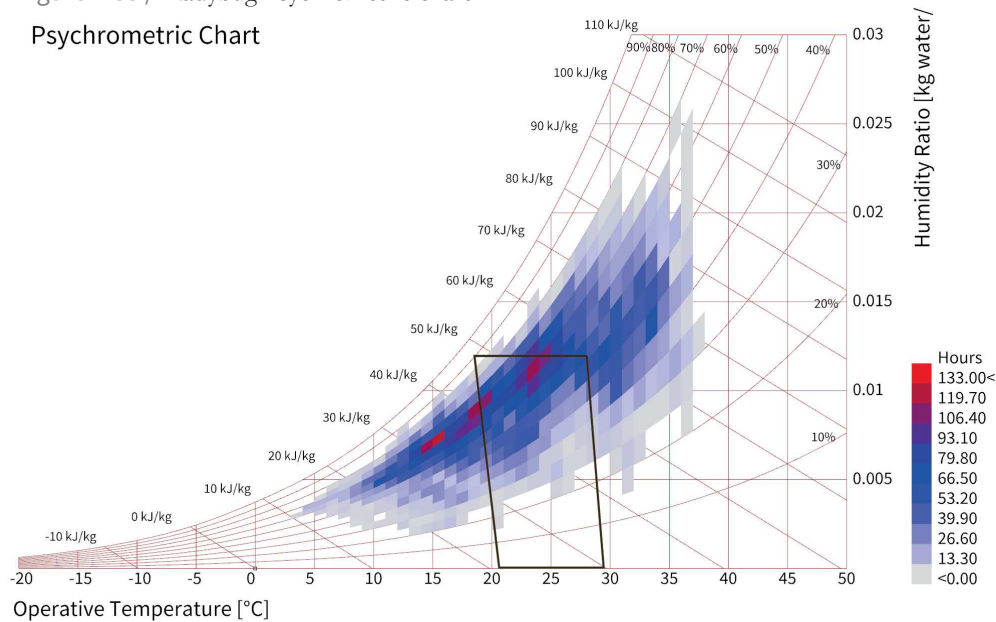

Figure 156 / Psychrometric chart output SmNsSn - the color gradient represents the amount of hours / year in which that environmental condition occurs

### Parametric model output

The dynamic annual simulations are useful to evaluate certain building performances, related to parametric design features.

This simulation campaign regards the emergency housing module, made of cardboard, set in Mediterranean climate. The parametric design features, object of this study, are the opening sizing and the shading system. The purpose is to find the best combination of these features that allows to maximize the percentage of time of daylight autonomy, and maximize the percentage of hours in comfort.

#### PMV comfort analysis settings

According to P. O. Fanger formulations, that have been already described in paragraph 5.2, Predict Mean Vote is a quantity parameter of the thermal comfort condition perceived by an individual that wears a specific clothing and does a specific work in a given environment.

The idea is to use the annual percentage of hours in comfort condition to define the best effective combination of the parameters, object of this study (i.e. windows and shadings). The need of a design tool that is cogent in stressing the design configuration is the reason for the choice of using PMV comfort model, instead of using the typical model for free running simulations, the Adaptive comfort model. The latter adopts the high levels of adaptability of human body to warm environment condition, by overestimating the benefits of natural ventilation. It means that the area of comfort in psychrometry chart increases. Thus, in order to design the best configuration, the Adaptive comfort model flattens the improvements of the design strategies.

- The *Ladybug PMV Comfort Calculator* includes some parameters through the component *Ladybug PMV Comfort Parameters*. This component allows to sharpen the boundary conditions of the comfort, by defining:
  - *PPD Comfort Threshold* – a number between 5 and 100 that represents the percentage of dissatisfied people. This number is of 10% both for Ashrae 55 (US) and ISO 7730 (Europe), it means that the range of

	code	thermal zone	MET	CLO	% hours daylight auto	% hours in comfort
1.1	SsNsSn	living	1,1	0,5÷1.1	49,7	31,7
1.2	SsNsSn	bathroom	1,2	0,5÷1.1	49,7	41,9
1.3	SsNsSn	bedroom	0,7	0,5÷1.5	50,2	15,7
2.1	SsNsSs	living	1,1	0,5÷1.1	49,7	31,1
2.2	SsNsSs	bathroom	1,2	0,5÷1.1	49,7	42,0
2.3	SsNsSs	bedroom	0,7	0,5÷1.5	50,2	16,1
3.1	SmNsSn	living	1,1	0,5÷1.1	49,8	32,6
3.2	SmNsSn	bathroom	1,2	0,5÷1.1	49,6	42,1
3.3	SmNsSn	bedroom	0,7	0,5÷1.5	50,3	15,6
4.1	SmNsSs	living	1,1	0,5÷1.1	49,8	31,6
4.2	SmNsSs	bathroom	1,2	0,5÷1.1	49,6	42,2
4.3	SmNsSs	bedroom	0,7	0,5÷1.5	50,3	16,1
5.1	SlNmSn	living	1,1	0,5÷1.1	50,2	34,1
5.2	SlNmSn	bathroom	1,2	0,5÷1.1	50,5	43,3
5.3	SlNmSn	bedroom	0,7	0,5÷1.5	49,6	15,5
6.1	SlNmSs	living	1,1	0,5÷1.1	50,2	33,5
6.2	SlNmSs	bathroom	1,2	0,5÷1.1	50,5	43,1
6.3	SlNmSs	bedroom	0,7	0,5÷1.5	49,6	15,8

Table 21/ Results of Daylight simulation and EnergyPlus simulation: percentage of hours of daylight autonomy and percentage of hours in comfort

comfort in Fanger's scale is:  $-0,5/+0,5$ . This percentage is quite restrictive and therefore it is preferable to set it at 20%, admitting a range of comfort in Fanger's scale:  $-1,0$  slightly cool /  $+1,0$  slightly warm.

□ *Maximum Humidity Ratio* – a number between 0,012 and 0,030 that limits the maximum humidity ratio acceptable for comfort. In many cultures and for many people, humidity in conditions of no thermal stress is not considered a source of discomfort and, accordingly, this component does not set an upper limit on humidity by default. However, for some people, stickiness, deriving from humidity in cool conditions, is considered uncomfortable and, if they want to face such a situation, they might set an upper limit on the acceptable humidity ratio here. The ASHRAE 55 PMV comfort standard recommends a maximum humidity of 0,012 kg water/kg air.

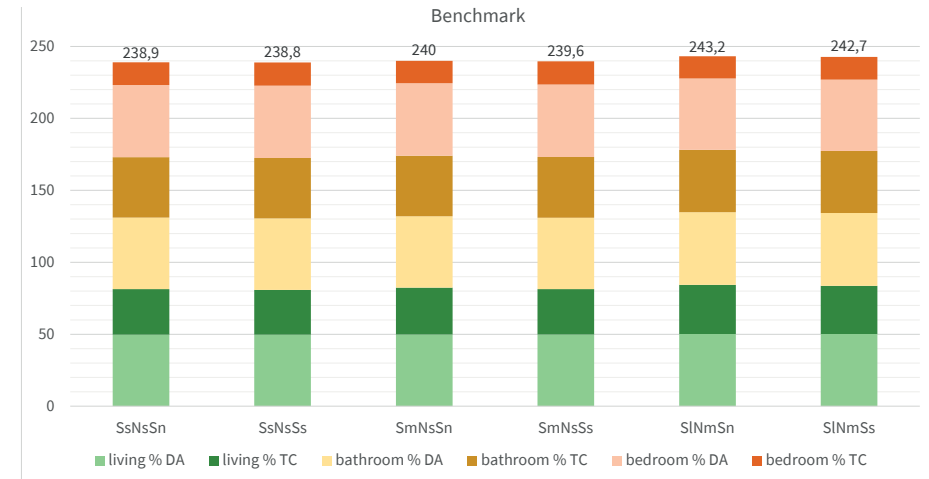

Figure 157/ Benchmark comparison between the 6 combinations of openings sizes and shading system - on the ordinate axis: the sum percentage in comfort and in daylight autonomy

	code	South openings	North openings	Shading system
1	SsNsSn	94 cm	94 cm	none
2	SsNsSs	94 cm	94 cm	scheduled
3	SmNsSn	115 cm	94 cm	none
4	SmNsSs	115 cm	94 cm	scheduled
5	SlNmSn	220 cm	115 cm	none
6	SlNmSs	220 cm	115 cm	scheduled

Table 22/ Result of Benchmark comparison

### Results

The results of this simulation campaign are very close to each other thanks to the mildness of Mediterranean climate, and the occupancy programme of each thermal zone.

The psychrometric charts, shown in Appendix A, highlight how the width of the openings brings more advantages in the cold period, through solar gains, than disadvantages through overheating in the hot period. Also the presence of shadings determines a reduction of potentiality of solar gains in cold periods, causing a reduction of overall thermal comfort.

The benchmark comparison highlights the best combination of parametric design features in: SlNmSn.

## 5.7 Executive design

### Detailing of components

The objective of form-finding, presented in the previous paragraph, allows to define the components of final design, with particular attention to stratigraphy.

Here are presented the drawings of stratigraphy details, based on the study of industrial technical sheets, most of them collected in Appendix B.

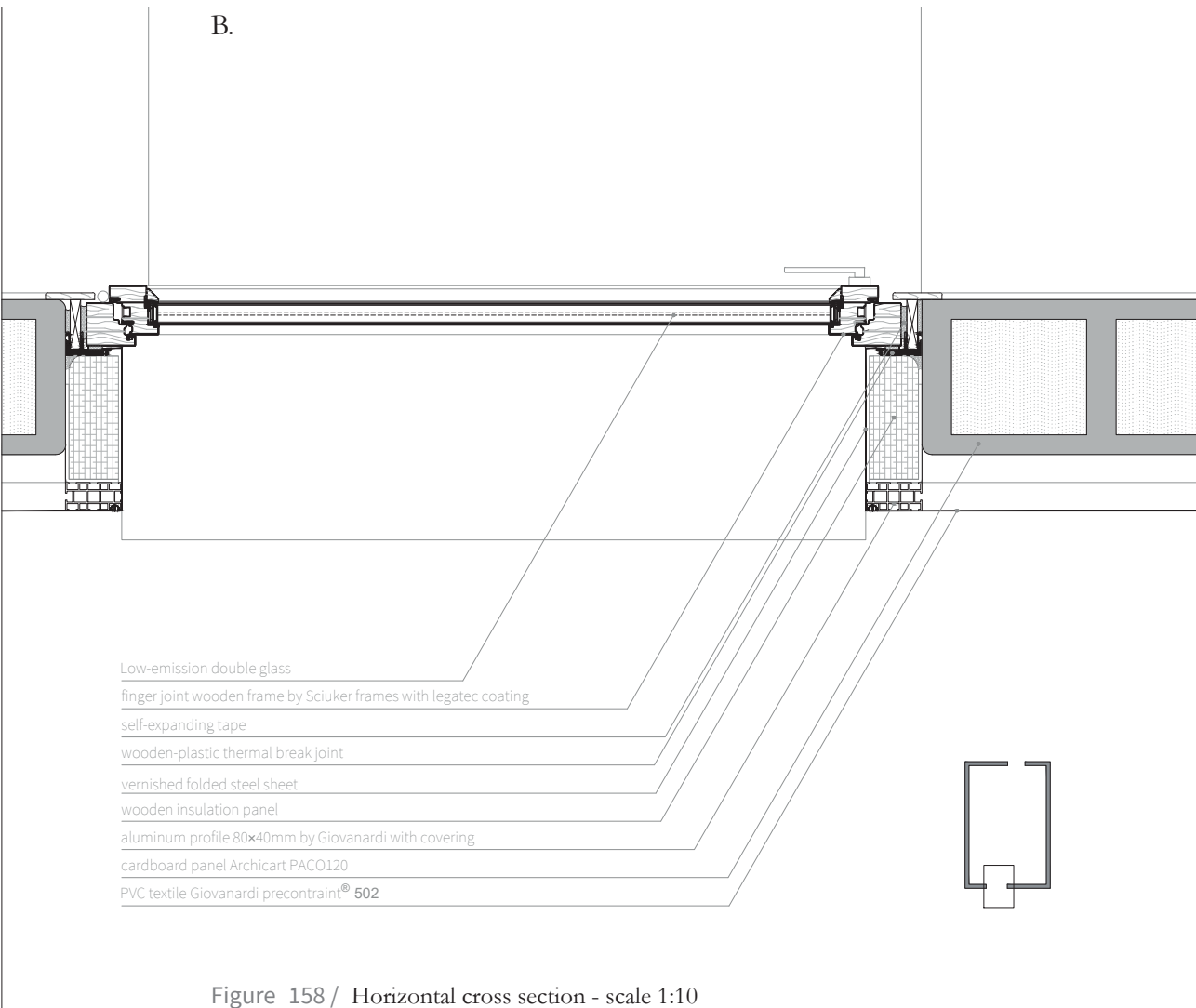
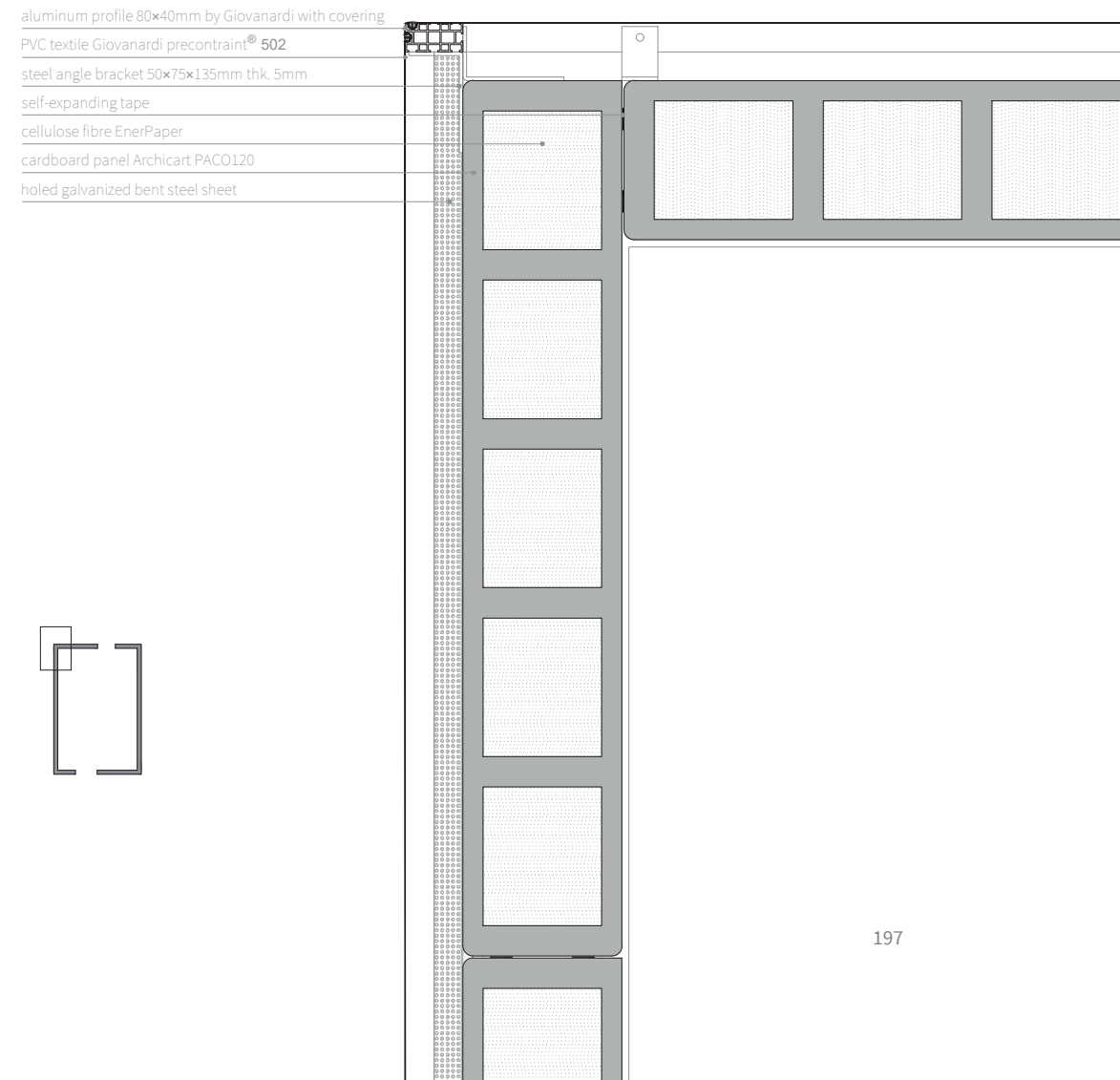
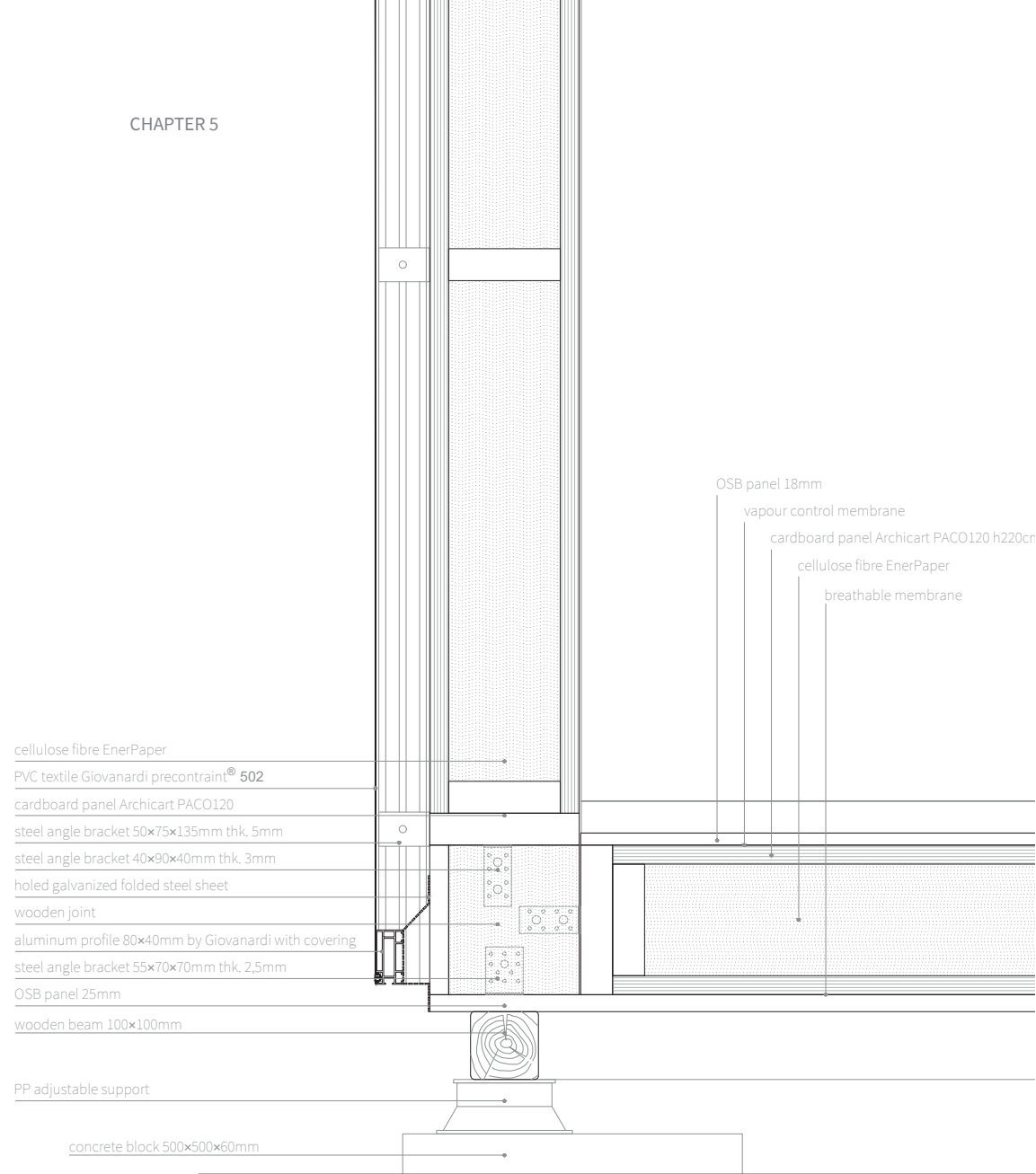

Figure 158 / Horizontal cross section - scale 1:10

Figure 159 / Horizontal cross section - scale 1:10





- cellulose fibre EnerPaper
- PVC textile Giovanardi precontraint® 502
- cardboard panel Archicart PACO120
- steel angle bracket 50x75x135mm thk. 5mm
- steel angle bracket 40x90x40mm thk. 3mm
- holed galvanized folded steel sheet
- wooden joint
- aluminum profile 80x40mm by Giovanardi with covering
- steel angle bracket 55x70x70mm thk. 2,5mm
- OSB panel 25mm
- wooden beam 100x100mm
- PP adjustable support
- concrete block 500x500x60mm

- OSB panel 18mm
- vapour control membrane
- cardboard panel Archicart PACO120 h220cr
- cellulose fibre EnerPaper
- breathable membrane

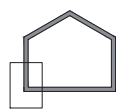
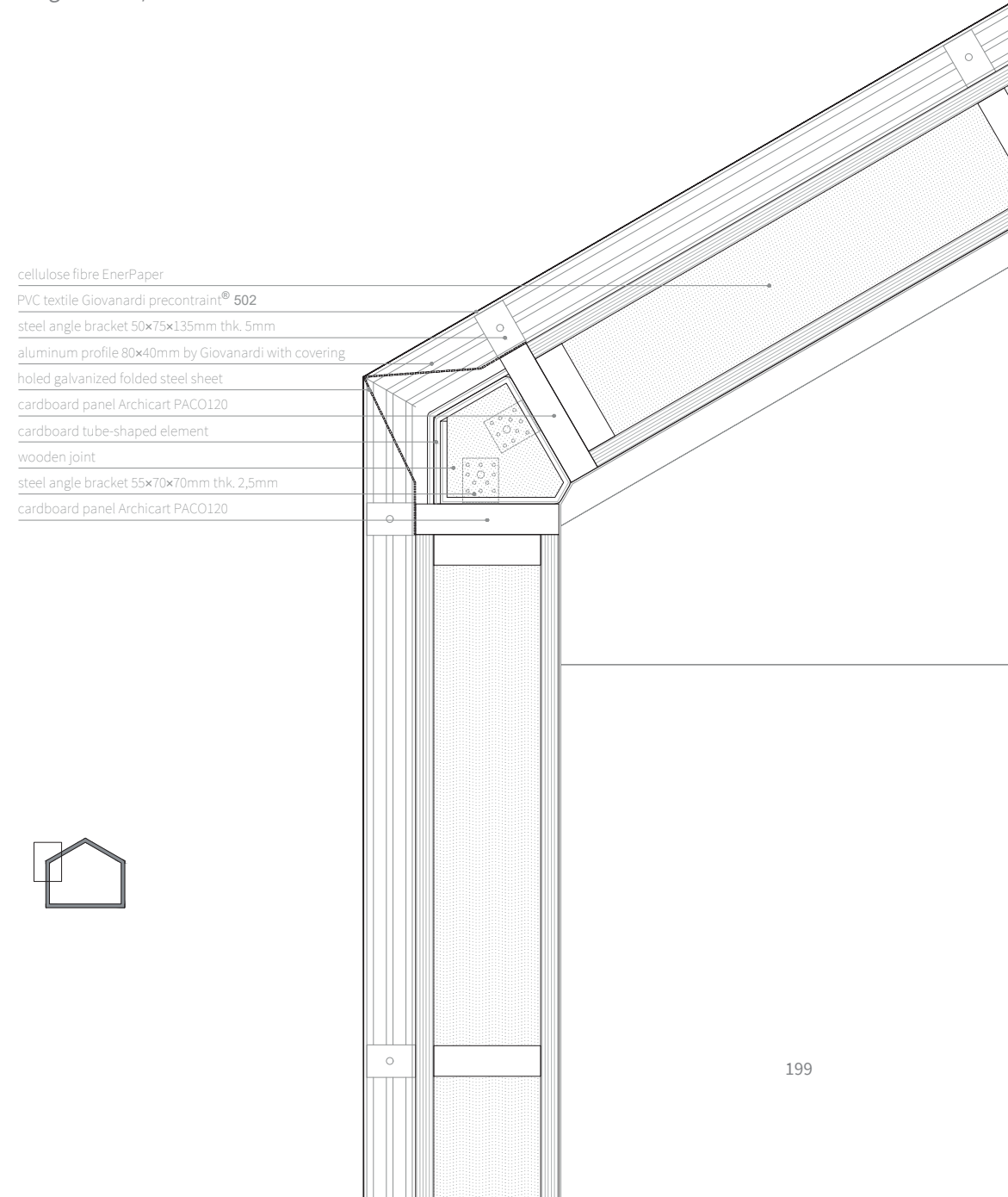

Figure 160 / Vertical cross section - scale 1:10

Figure 161 / Vertical cross section - scale 1:10



- cellulose fibre EnerPaper
- PVC textile Giovanardi precontraint® 502
- steel angle bracket 50x75x135mm thk. 5mm
- aluminum profile 80x40mm by Giovanardi with covering
- holed galvanized folded steel sheet
- cardboard panel Archicart PACO120
- cardboard tube-shaped element
- wooden joint
- steel angle bracket 55x70x70mm thk. 2,5mm
- cardboard panel Archicart PACO120

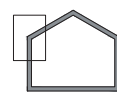
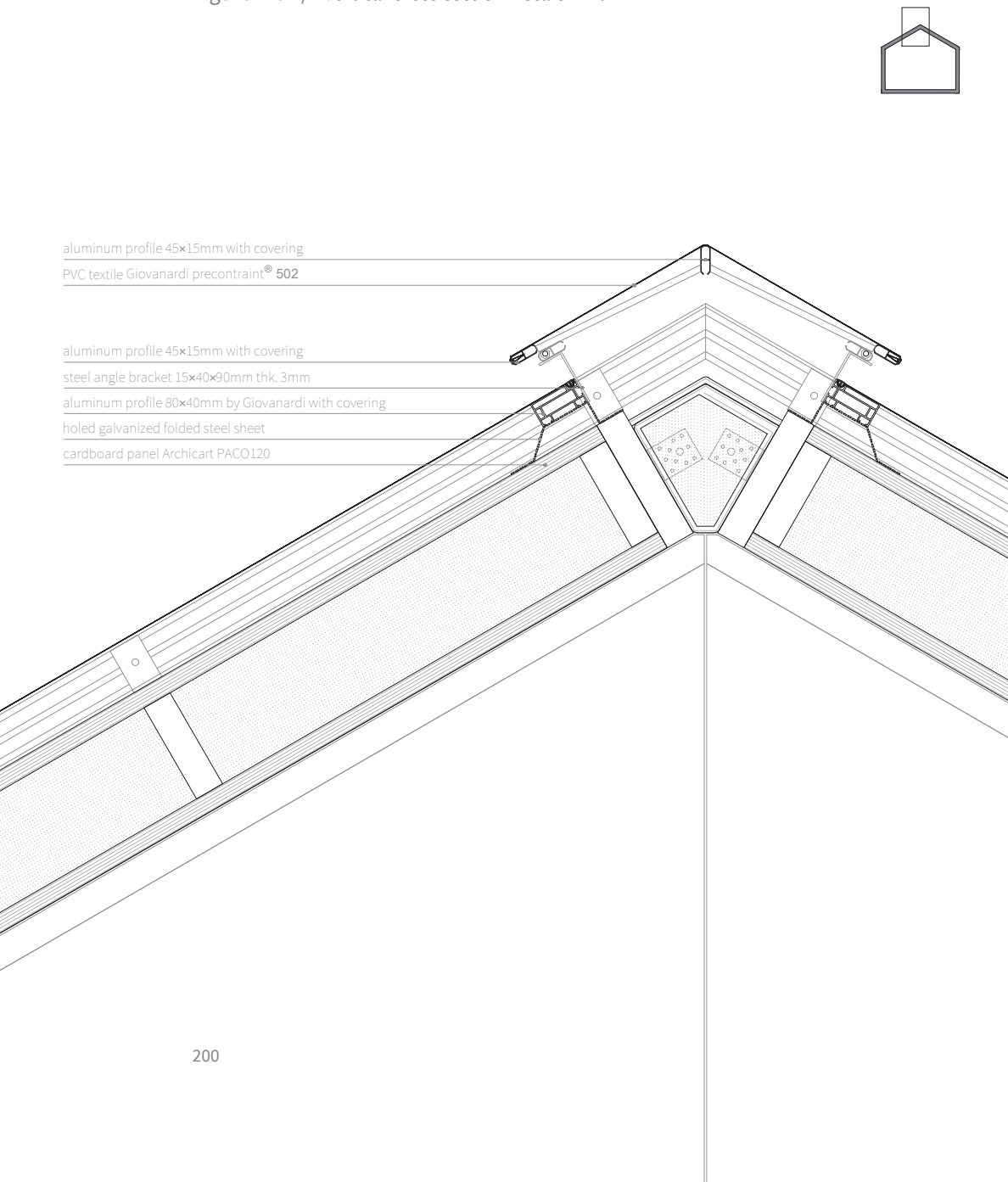

Figure 162 / Vertical cross section - scale 1:10



## Footnotes chapter 5

- 1 UNHCR (2018), p. 4
- 2 Olgyay V. (1963), p. 12
- 3 ANSI/ASHRAE Standard 55-2004
- 4 Fanger P. O. (1970), p. 224
- 5 Szokolay S. V. (2004), p. 51
- 6 *ibidem*, p. 5
- 7 *ibidem*, p. 57
- 8 *ibidem*, p. 54
- 9 *ibidem*, p. 59
- 10 Mackey C. and Roudsari M. S. (2018), p. 97
- 11 UNHCR (2018), p. 6
- 12 Civil Protection Department (2005), p. 11-23
- 13 Civil Protection Department (2005), p. 24



## 6/ T-Box

Every creative process generates a final product that can have several forms and is necessary to communicate, to test and to rethink the result of the process. These forms can be sketches, technical drawings, diagrams, post-it, models, prototypes, photo, video, etc. .

This chapter describes the production of a full-scale prototypem of the prefabricated housing module made of cardboard and its testing variables: self-construction and environmental performances.

## 6.1 The meaning of prototyping

Prototyping is an integral part of design thinking, because it allows to quickly test ideas and to improve them in an equally timely lapse of time.

The Institute of Design at Stanford *d.school* in its Bootcamp Bootleg<sup>1</sup> presents a guide that explains the development of design process. It consists of 5-steps.

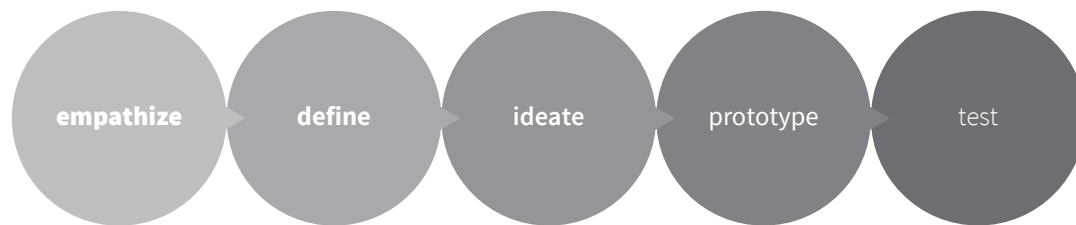

Figure 163 / Design process - d.school

### Empathize

The focus of design process is often human-centred, and, for this reason, it is essential to comprehend the people to whom the design is destined.

The problems, that this work is trying to solve, are those of actual users; in order to design for our users, we must build empathically, going along with their needs and wishes and respecting what they consider important.

### Define

The two goals of this step are developing a deep understanding of users and of the design space and, on the basis of that understanding, coming up with a feasible problem statement: the designer's point of view. It should be a guiding statement that focuses on specific users, and their insights and needs, that have been uncovered during the empathize phase.

In order to be truly generative, it needs often to firstly reframe the challenge, on the basis of the new insights gained through the design work.



### Ideate

Ideate is the step of the design process in which the aim is to generate radical design alternatives. Mentally it represents a process of *going wide*, in terms of concepts and outcomes. The goal of ideation is to explore a wide solution space, both as large quantity of ideas and as diversity of those ideas. This vast depository of ideas allows to build prototypes to test with users.

### Prototype

Prototyping is getting ideas and explorations out of the head and into the physical world. A prototype can be whatever had a physical form: a wall of post-it notes, a role-playing activity, a space, an object, an interface, or even a storyboard. The resolution of the prototype should be commensurate with the progress of the project. In primary explorations the prototypes should be rough and rapid, in order to allow to learn quickly and investigate a lot of different possibilities.

Traditionally prototyping is thought as a way to test the functionality. However, prototyping is used for many reasons, including the following categories:

- *Empathy gaining* - Prototyping is a tool to deepen the understanding of design space and users, even at a pre-solution phase of the project.
- *Exploration* - Build to think. Improvement of multiple solution options.
- *Testing* - Creating prototypes (and developing the context) to test and refine solutions with users.
- *Inspiration* - Inspiring others (teammates, clients, customers, investors) by showing the designer's vision.

Some goals of prototyping phase are:

- *Learn* - If a picture is worth a thousand words, a prototype is worth a thousand pictures.
- *Solve disagreements* - Prototyping is an effective tool that can: eliminate ambiguity, assist in ideation, and reduce miscommunication.

- *Start a conversation* - A prototype can be a great way to have a different kind of conversation with users.
- *Fail quickly and cheaply* - Creating quick and rough prototypes allows to test a number of ideas, without wasting much time and money.
- *Manage the solution-building process* - Identifying a variable to break a big problem up into smaller, testable chunks.

### Test

Testing is the chance to get feedback on solutions, refine solutions to make them better, and continue to add information about users. The test is an iterative mode, in which the artefact takes place in the appropriate context.

The logic concept is: Prototype as if you know you're right, but test as if you know you're wrong.

## 6.2 The prototype purposes

The first step of programming a prototype is understanding the variables that are going to be tested, in order to define what kind of prototype it is needed. It means understanding what is going to be learned by making a prototype.

The testing variables of the cardboard emergency house-kit are of two types: direct and indirect.

- Direct variables
  - thermophysical performances
  - level of self-construction.
- Indirect
  - aesthetic qualities
  - improving of awareness
  - increasing knowledge.

The evaluation of the direct variables is planned both during the implementation of the prototype and during its operation.

### Level of self-construction

Refugees, displaced and affected populations should be empowered at all stages to participate to shelters' implementation, in order to make them acceptable, appropriate and sustainable both culturally and humanly.

A crisis event can affect large sections of the population, without distinction. For this reason, the aim of employing the victims in building their own shelters is not easy. There could be men, elderly, women, children, sick people, disabled, and they often could suffer of post-traumatic stress disorder (PTSD).

Therefore, the goal of making an emergency self-made shelter can only be achieved by ensuring the following conditions:

- participation
- cooperation
- sharing
- relation.

These conditions can be easily verified by putting the pilot self-construction project into action among a variegated group of people, and achieving the main objectives: carrying it out, carrying it out well, carrying it out in time. Of course, there must be an on-site operation coordinator, who has the role of verifying the best progress of building site. The coordinator continuously receives feedbacks from the people involved, and, this way, the process improves, becoming different from the initial project.

The self-construction strictly dependent on an initial project is called *coordinated self-construction* and the architectural project must be supplemented by a series of specific drawings aimed at making self-construction possible. If it is desired that the coordinated self-construction be understood by all and proceed quickly, it is necessary that someone more experienced than the self-builders assist the construction site. This type of self-construction is called *guided self-construction*. The guide should not only be a technician or one who believes in self-construction but a person who believes in the human and social value of work done together and in a certain way, who believes in the value of an experience lived by a group of

people and who know how to participate in everyone's work<sup>2</sup>.

### Environmental performances

This second goal is achievable only if the first one has already been achieved, because it consists in a campaign of tests conducted on real scale prototypes, in order to evaluate:

- levels of thermal comfort
- surfaces parameters (temperature, humidity)
- heat flow measures.

Indirect variables are not object of test, but the prototyping itself could produce indirect benefits in the participants, in terms of awareness and knowledge, and in the prototyping site, in terms of aesthetics.

### Prototyping plan

The organization of the prototyping phase of the emergency house-kit was conceived as specified below:

- *design of prototype* – individuation of site, sizing and producing of executive drawings
- *engagement of participants* – individuation of categories of participants, definition of application call, definition of an agreement
- *obtaining authorization* – request to competent technical body, fulfillment of the requests
- *involving partners and sponsors* – identification of companies able to offer technical sponsorship, involving them through the promise of press communication
- *timeline of prototyping* – definition of roles, organization of building site, defining the timeline of operations
- *building the prototype* – monitoring the building site, taking feedbacks, updating the project, redefining procedures, completing building
- *closing the prototyping* – cleaning the building site off, inaugurating the prototype building.

## 6.3 Tools

The phase of real experimentation has been faced by equipping ourselves with two categories of instruments: certified test equipment, and innovative experimental equipment.

- Certified equipment
  - Heat Flow meter - measures the transmittance (U-value) of the building on which it is applied, and the temperature of internal and external surfaces.
  - PMV/PPD - thermal comfort equipment - analysis of moderate environments through PMV and PPD index.
- Experimental equipment
  - Domino – measures both internal and external surfaces and the relative humidity inside the cardboard panels
  - Self-construction manual – collects the construction protocol of the cardboard house-kit. It is presented in the Annex C.

### Heat flow meter – Thermozig

The Thermozig heat flow meter is a professional instrument equipped by a central device and a network of wireless sensors. The transmittance of the structure is measured on site, according to the ISO 9869 standard.

The complete acquisition system consists in the displacement of one



Figure 164 / Thermozig datalogger DL01 - OptiVelox

or more measurement nodes, equipped with appropriate sensors, and a DL01 appliance.

The DL01 device is a high-performance data logger, designed to operate in a wireless network. Each device is equipped with a radio modem, operating according to the ZigBee standard; the communication takes place via a star network in which DL01 represents the centre. Sensor data are sent by measurement nodes to the data logger, that records them on a non-volatile memory. The data can be transferred from the DL01 via USB interface.



Figure 165 / Radio modem RM01 and probe device FE01 - OptiVelox

Each FE01 device is a complete multi-channel acquisition system expressly designed for accurate measurements of surface temperatures and heat flows. In the device there are measurement sensors, signal conditioning circuits and interface circuits with the radio modem.

An RM01 series radio modem can be directly connected to the DB9 connector of FE01; once connected, both devices are powered by the internal battery of the radio modem.

- Features FE01-2A
  - Front-End with 2 channels:
    - 1 temperature probe
    - 1 temperature probe

- Data resolution: 16 bit
  - Sampling time: 1÷65535 s
  - Power supply: 3,3÷5,1 Vdc; 0,01÷5 mA
  - Temperature range: -20° ÷ +60°C (RH max 85% 25°C)
  - Size: 40×40×20 mm
  - Weight: 45 g
- Features FE01-3B
    - Front-End with 3 channels:
      - 1 temperature probe
      - 1 temperature probe (inside the flow sensor)
      - 1 heat flow meter
    - Data resolution: 16 bit
    - Sampling time: 1÷65535 s
    - Power supply: 3,3÷5,1 Vdc; 0,01÷5 mA
    - Temperature range: -20° ÷ +60°C (RH max 85% 25°C)
    - Size: 40×40×20 mm
    - Weight: 45 g
- Temperature probe
    - Probe type: RTD Pt1000, Class 1/3 B (DIN/IEC751)
    - Response time: 8 s
    - Operation range: -50 ÷ +125°C
    - Resolution: 0,01°C
    - Accuracy:  $\pm (0,10+0,0017|t|)$  °C
    - Matching:  $\pm 0,05$ °C (channels difference T=20°C)
    - Cable: L = 1,4 m
    - Size: Ø20 × 3 mm
    - Weight: 1,5 g
- Heat flow probe
    - Probe type: RTD Pt1000, Class 1/3 B (DIN/IEC751)

- Response time: 4 min
- Operation range: -300 ÷ +300 W/m<sup>2</sup>
- Resolution: 0,01 W/m<sup>2</sup>
- Accuracy:  $\pm 5\%$  (T=20°C)
- Temperature range: -20 ÷ +60°C
- Thermal resistance: <0,006 m<sup>2</sup>K/W
- Size: Ø80 × 5,5 mm
- Weight: 70 g

### PMV – PPD indices – DeltaOhm HD32.2

Microclimate term means the environmental parameters that influences the thermal exchanges between the humankind and the environments inside limited places, and that determinates the so-called “thermal well-being”. The micro-environmental weather factors together with individual work influences a series of biologic responses connected to well-being situations (Comfort) or thermal uneasiness (Discomfort). The human body, indeed, tries to keep the thermal balance in equilibrium conditions, in order to keep the body temperature on optimal values.

HD32.3 detects the following sizes:

- During the visualization of WBGT index:
  - tnw: wet bulb with natural ventilation temperature probe
  - tg: globe thermometer temperature
  - ta: ambient temperature
- During the visualization of PMV index:
  - va: air speed
  - tg: globe thermometer temperature
  - ta: ambient temperature
  - rh: relative humidity

In addition to the direct measurements made with the probes connected to the instruments, it can be directly calculated and visualized, in the PMV measurement, the medium radiant temperature  $t_r$ , the Predicted Mean Vote (PMV) and Predicted Percentage of Dissatisfied (PPD).



Figure 166 / HD32.2 equipped with TP3275, HP3217R and AP3203 - DeltaOhm

To calculate the Predicted Mean Vote (PMV) and Predicted Percentage of Dissatisfied (PPD) it is necessary that the following probes are connected:

- TP3276.2 or TP3275 globe thermometer probe
- HP3217.2 or HP3217R combined probe for the measurement of relative humidity and the air temperature
- AP3203.2 or AP3203 probe with warm wire for the measurement of the air speed.

To calculate the Predicted Mean Vote (PMV) and Predicted Percentage of Dissatisfied (PPD) it has to consider the regulations:

- ISO 7726
- ISO 7730:2005.
- TP3275 - Globe thermometer probe
  - Sensor type: Pt100

- Accuracy: Class 1/3 DIN
  - Measurement range  $-10 \div +100 \text{ }^{\circ}\text{C}$
  - Connection: 4 wires plus SICRAM module
  - Connector: 8-pole female DIN45326
  - Cable: 2m
  - Stem dimension:  $\text{Ø}=14 \text{ mm } l= 110 \text{ mm}$
  - Response time: T95 15 minutes
- HP3217, HP3217R - Combined probe for temperature and relative humidity
    - Sensor types: Thin film Pt100 for temperature + Capacitive sensor for relative humidity
    - Accuracy: temperature: 1/3 DIN; relative humidity:  $\pm 2.5\%$
    - Connection: temperature:  $-10 \text{ }^{\circ}\text{C} \div +80 \text{ }^{\circ}\text{C}$ ; relative humidity:  $5\% \text{ RH} \div 98\% \text{ RH}$
    - Connection: 7 wires plus SICRAM module
    - Connector: 8 -pole female DIN45326
    - Cable: Only HP3217R (2 m)
    - Dimensions:  $\text{Ø}=14 \text{ mm } l= 150 \text{ mm}$
    - Response time T95 15 minutes
  - AP3203.2, AP3203 - Probe with hot omnidirectional wire
    - Sensor type: NTC 10kohm
    - Accuracy:  $\pm 0,05 \text{ m/s } (0,05 \div 1 \text{ m/s}); \pm 0,15 \text{ m/s } (1 \div 5 \text{ m/s})$
    - Measurement range:  $0,05 \div 5 \text{ m/s}; 0 \text{ }^{\circ}\text{C} \div +80 \text{ }^{\circ}\text{C}$
    - Connection: 7 wires plus SICRAM module
    - Connector: 8-pole female DIN45326
    - Cable: Only AP3203 (2 m)
    - Stem dimension:  $\text{Ø}=8 \text{ mm } l= 230 \text{ mm}$
    - Protection dimension:  $\text{Ø}=80 \text{ mm}$

### Domino

It is the project<sup>3</sup>, developed by Gianfranco Distefano, which is born out of the collaboration between Department of Engineering Electric, Electronic and Informatics and the company Archicart-Area srl. Its name comes from *domus* (home) and *Arduino* (the basic technology used).

The Domino project aims to connect the technological systems of the cardboard housing module with the users' needs, in terms of services and thermal comfort level. To pursue this goal, Distefano designs a single Building Management System (BMS) based on a network of low-cost devices of open source technologies. The platform is equipped with Arduino-base and wireless Bluetooth Low-Energy (BLE) connection.

The idea behind Domino is to: measure some thermo-physical parameters of the corrugated cardboard envelope, collect data inside a remote

server, and implement adaptive strategies controlled by actuators.

This idea has led to a solution that consists in equipping some strategic panels of the envelope with a hierarchically organized configuration of equipment:

1 central node equipped with sensors, connected to the home network via Ethernet port, connected at peripheral nodes via BLE

multiple peripheral nodes equipped with sensors and connected at the central node via BLE.

The central node has the task of:

- acquiring data from peripheral nodes
- sending the collected data together with those locally detected to the remote server
- acquiring the user parameters
- notifying the peripheral nodes of the update.

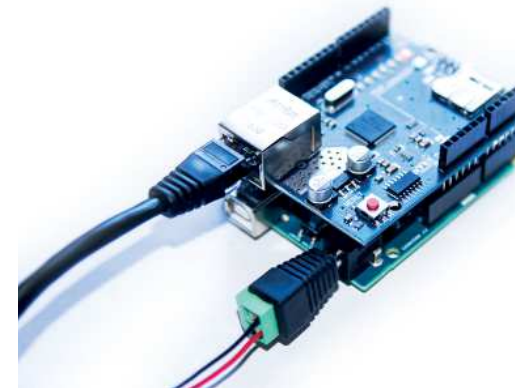
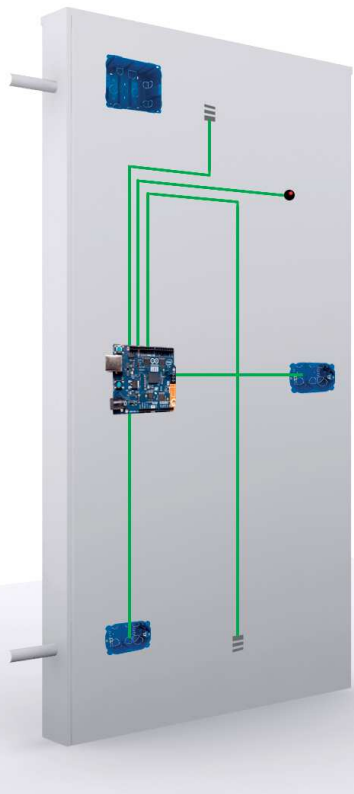

Figure 167 / ▲ Arduino™ Genuino101  
 Figure 168 / ◀ Archicart PACO wiring configuration

Figure 169 / Ethernet shield W5100 connected to Arduino™ Genuino101

name	nRF51822
BT version	Bluetooth® V4.1 BLE
working frequency	2,4GHz
modulation method	GFSK (Gaussian Frequency Shift Keying)
RF power	-20dBm ~ +4dBm
data rates	250 kbps, 1 Mbps, and 2 Mbps
sesitivity	-93 dBm

Table 23 / Datasheet of chip nRF51822 - Nordic Semiconductor



### Architecture of the nodes

Domino consists of a dedicated network composed by nodes, built on the shield Arduino™ Genuino101 (equipped with Intel®Curie™ chips), which includes a Nordic Semiconductor Bluetooth Low Energy controller, the SoC nRF51822, BLE 4.1 compliant.

The central node Arduino shield is also provided of Ethernet shield W5100.

#### □ Temperature probe

The DS18B20 digital sensor, produced by Dallas Semiconductor, consists in a pre-wired stainless steel probe that simplifies the installation



Figure 170 / Temperature probe DS18B20

name	DS18B20
type	Pt100
power supply	3-5,5 V DC
output signal	digital signal via One-Wire
measuring range	-55 ÷ +125 °C
resolution	9 ÷ 12 bit
sensing period Average	750ms <
accuracy	±0,5 °C (-10 ÷ +85 °C)

Table 24 / Datasheet of probe DS18B20 - Dallas Semiconductor

and makes the sensor waterproof. The communication with the Arduino shield occurs by the One-Wire bus, a communication system developed by Dallas Semiconductor. This system is supported by the Arduino shields through the implementation of a dedicated library.



Figure 171 / Humidity probe DHT21

name	DHT21	
	Relative Humidity	Temperature
power supply	3-5,5 V DC	
output signal	digital signal via single-bus	
measuring range	0 ÷ 99%	-40 ÷ 80°C
resolution	0,1%	±0,1°C
accuracy	±3%	±0,3%
long term stability	±0,3% / year	
sensing period Average	2s	
size	26,7×58,8×13,8 mm	

Table 25 / Datasheet of chip DHT21 - Aosong Electronics Co. Ltd

#### □ Relative humidity probe

The DHT21 sensor, provided by Aosong Electronics Co. Ltd, is a digital sensor able to detect the relative humidity and the temperature of the environment in which it is placed.

### Architecture of panels wiring

The Domino system is wired inside some pilot panels, spread into the building envelope. Each panel is equipped with 2 humidity probes DHT21

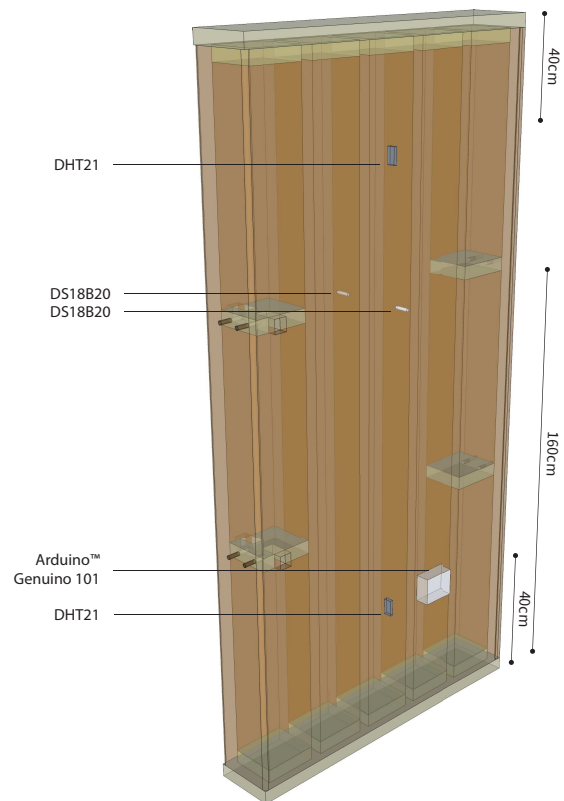

Figure 172 / Mockup of T-Box panel wiring

(placed inside the panel at a distance of 40 cm, one from the top, and the other from the bottom), 2 temperature probe DS18B20 (placed inside and outside the building) and 1 Arduino Genuino 101.

The wiring of the sensors and actuators requires a dedicated line, that has to be independent from the high voltage one. The circuit is able to supply a voltage equal to 12 Vdc, sufficient to supply the boards and the sensors connected to them.

### Architecture of GUI

The Domino system is designed to manage the connection of several housing units through a remote server. The employment of a remote server allows the users of the housing modules to access to their own user profile every time and wherever they are. The remote server hosts a mysql database dedicated to the storage of the data sent by the central node of each housing module and also to storage the parameters customized by the users.

The database is a structural element of the Domino project and completes its architecture. Thanks to the integration of the database, Domino project allows interaction between the user and the cardboard house-kit.

The employed dbms (database management system) is *mysql* and the queries for data manipulation are implemented in php algorithms that regulate executions and security.

Access credentials are stored in an encrypted file within a folder excluded from the server root; this way the file path cannot be indexed on the server.

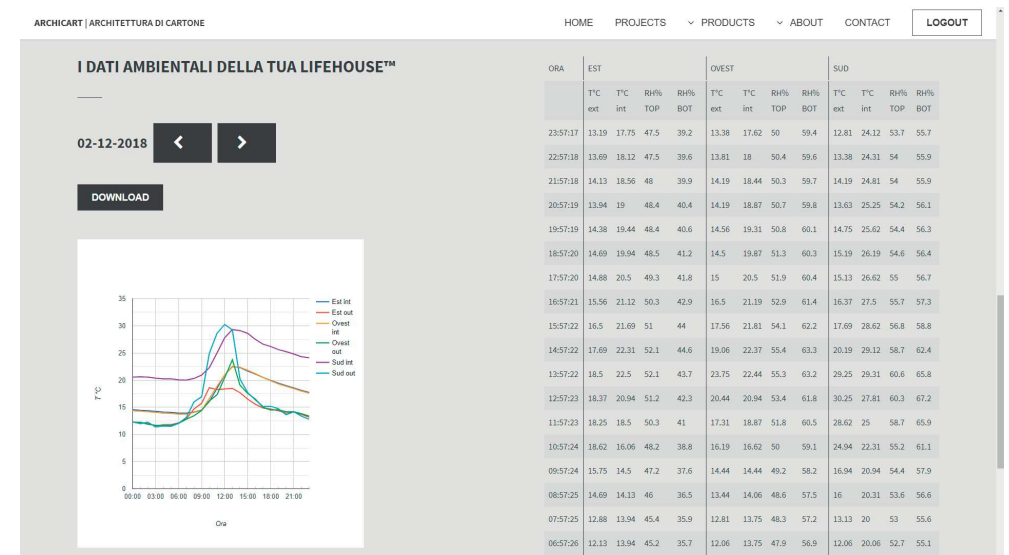

Figure 173 / Preview of website GUI

## 6.4 Prototyping of a cardboard house-kit

### Design of prototype

The project of a full-scale prototype of the cardboard emergency house-kit starts from its executive design.

The prototype's size should provide the sufficient space to perform testing and to plan dissemination events, in addition to the main purpose of allowing the evaluation of all assembly issues.

The prototype is called *test-box*, because it represents a minimum scien-

name	location	size	owner	authorities	supervisor
<b>T-Box</b>	University Campus of Catania	20m <sup>2</sup>	DICAR University of Catania	APSEMa / SPPR Unict	Archicart Area srl

Table 26 / Outline of the places and subjects involved

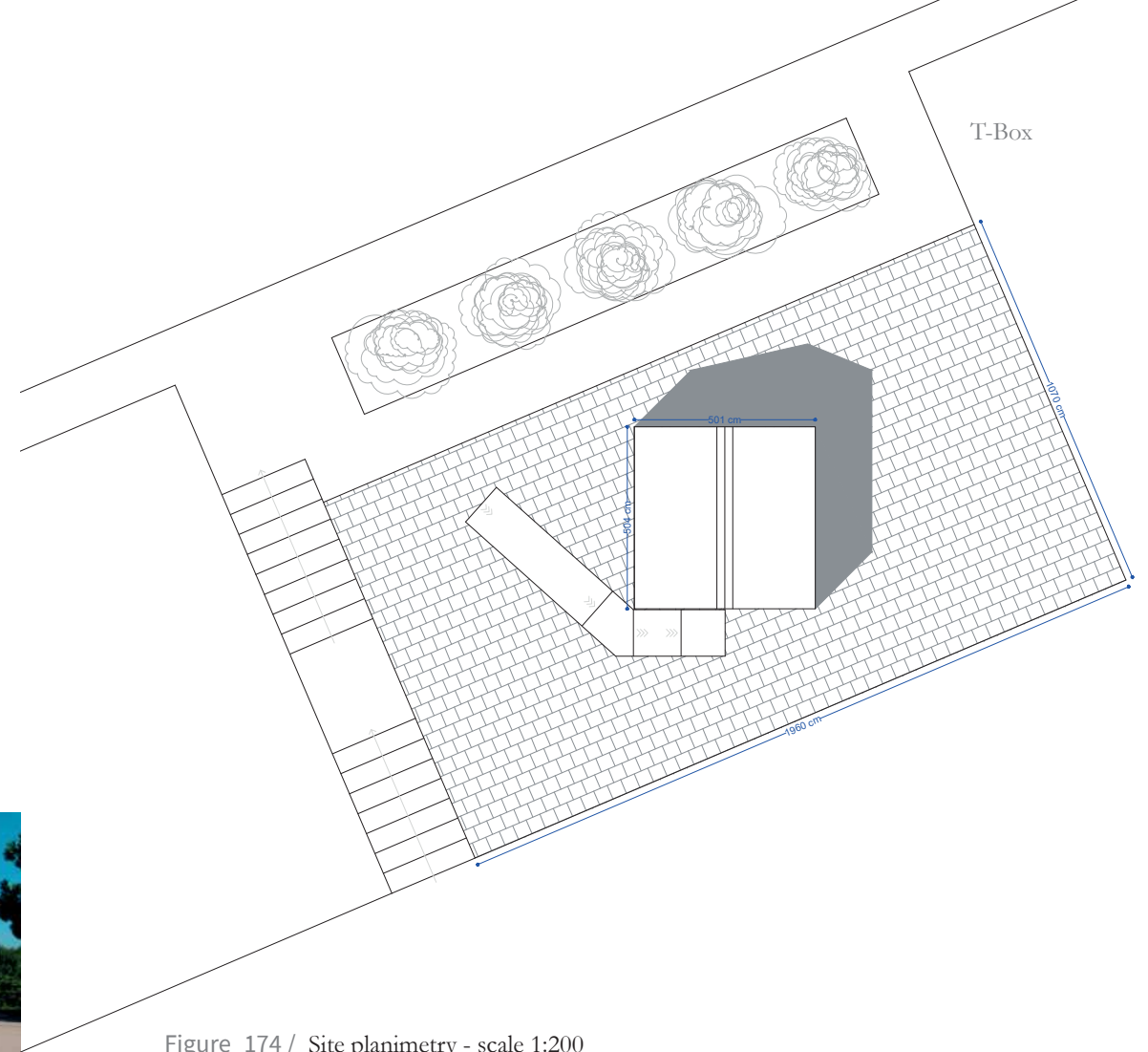
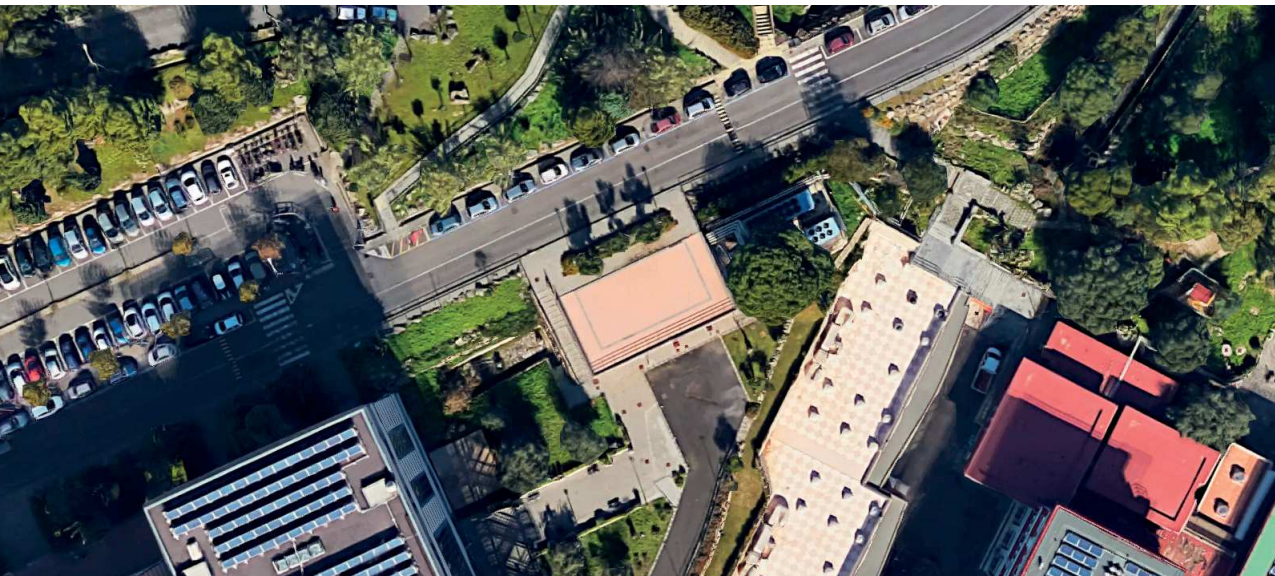

Figure 174 / Site planimetry - scale 1:200

tific test environment. In the following part of this work, it will be shortened T-Box.

The T-Box has a size of about 20m<sup>2</sup>, useful to fulfil all research needs.

The site of installation has been individuated in the University Campus of Catania, on the flat roof of a technical room belonging to the engineering department. The table below summarizes its features.

The architectural project is developed on a 1:100 scale, while the executive project is realized in a 3D model that allowed the verification of stratigraphy and connections.

A first output of prototyping is the self-construction manual produced, starting from the elaboration of axonometric views from the 3D model.

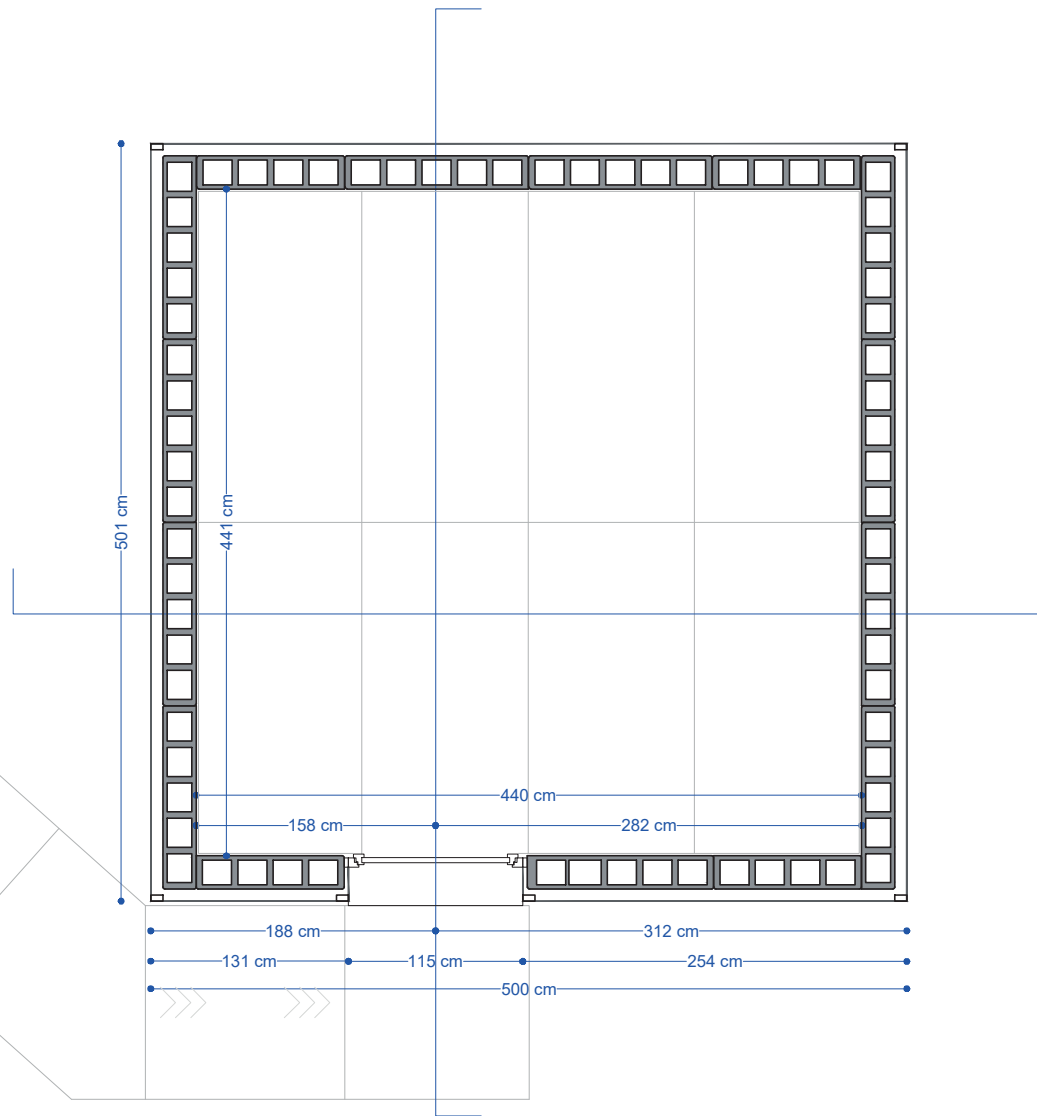

Figure 175 / Horizontal cross-section - scale 1:100

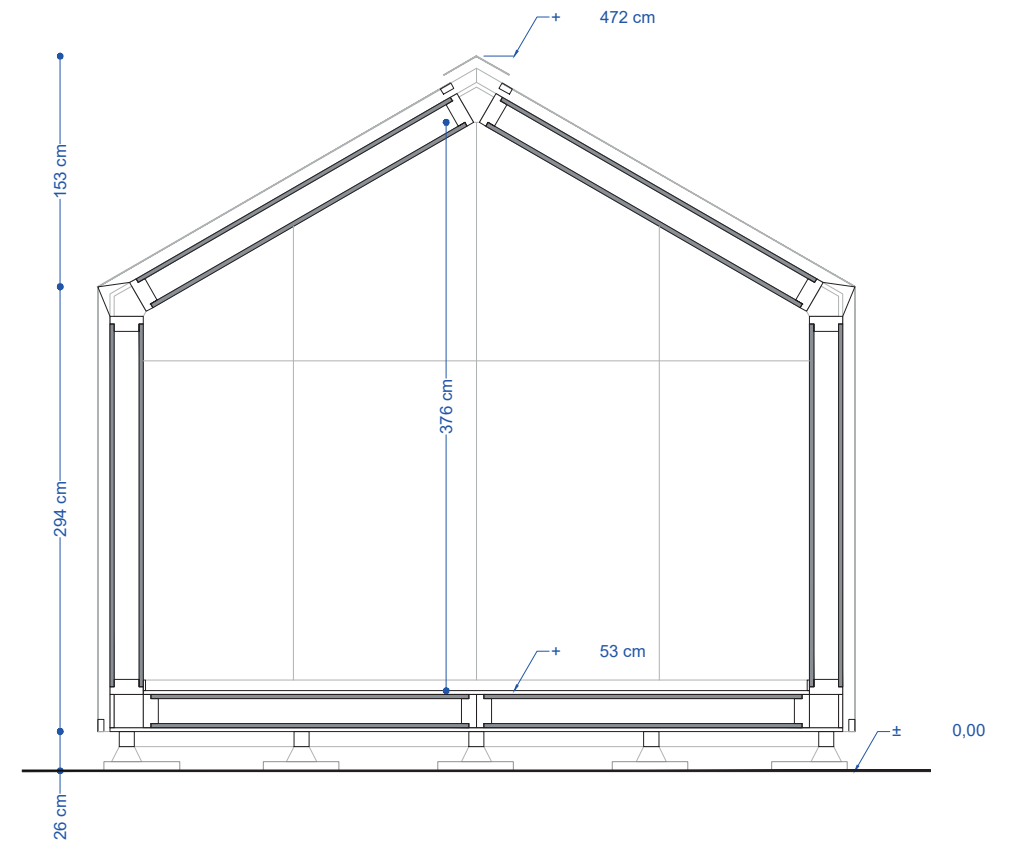

Figure 176 / Vertical cross-section - scale 1:100

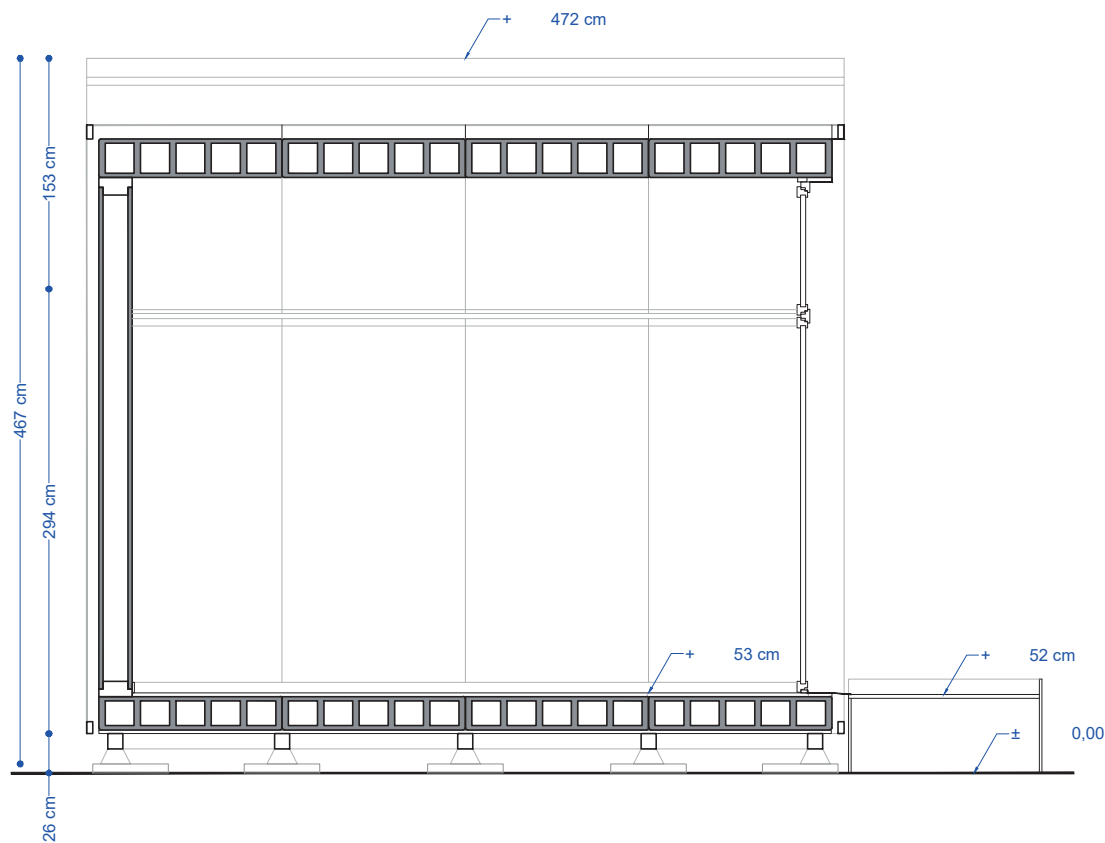

Figure 177 / Vertical cross-section - scale 1:100

### Involvement of participants

The identification of the category of participants in the self-construction process is solved by the choice of involving university students. In particular, it is decided to engage a group of up to 30 university students for the construction phase and a smaller group of 15 school students for the monitoring phase. The distinction is motivated by the level of preparation necessary to face the constructive process and the monitoring one.

The idea behind the involvement of students is creating an advanced training course for them, in the field of building production related to dry technologies. For this reason, it is proposed a workshop called *T-Box Masterclass* based on the self-construction of the experimental prefabricated T-Box housing module, organized in two phases: *buildbox* and *livebox*.

□ *Buildbox* - it consists of lectures, exercises, manufacture and self-construction. Lessons and exercises have been useful to present and each element and material used for the manufacturing of the prototype, from the filling of the wall panels to the outer casing body. The prototype has been realized by the workshop participants. The core of this didactic moment has been both the description of all the physical characteristics of the t-box to the students, and the key role of the partners in the fulfilment of this fundamental design step.

□ *Livebox* - the second phase was organized in 4 workshops based on the installation of various monitoring equipment and on the conduction of targeted analysis tests and the characterization of 4 regimes of operation: winter, spring, summer and autumn.

The proposal of a call for a training workshop was carried out through the collaboration of Archicart, Area srl company, the main partner of the project. For this purpose, an academic partnership agreement was established between the innovative start-up Area srl and the Department of Civil Engineering and Architecture.

The agreement provides, among other things, collaboration in the organization of advanced training courses for the department students.

At the end of the call, 31 students were selected for the buildbox workshop and 15 students for the livebox workshop.

Figure 178 / Cover of the workshop announcement

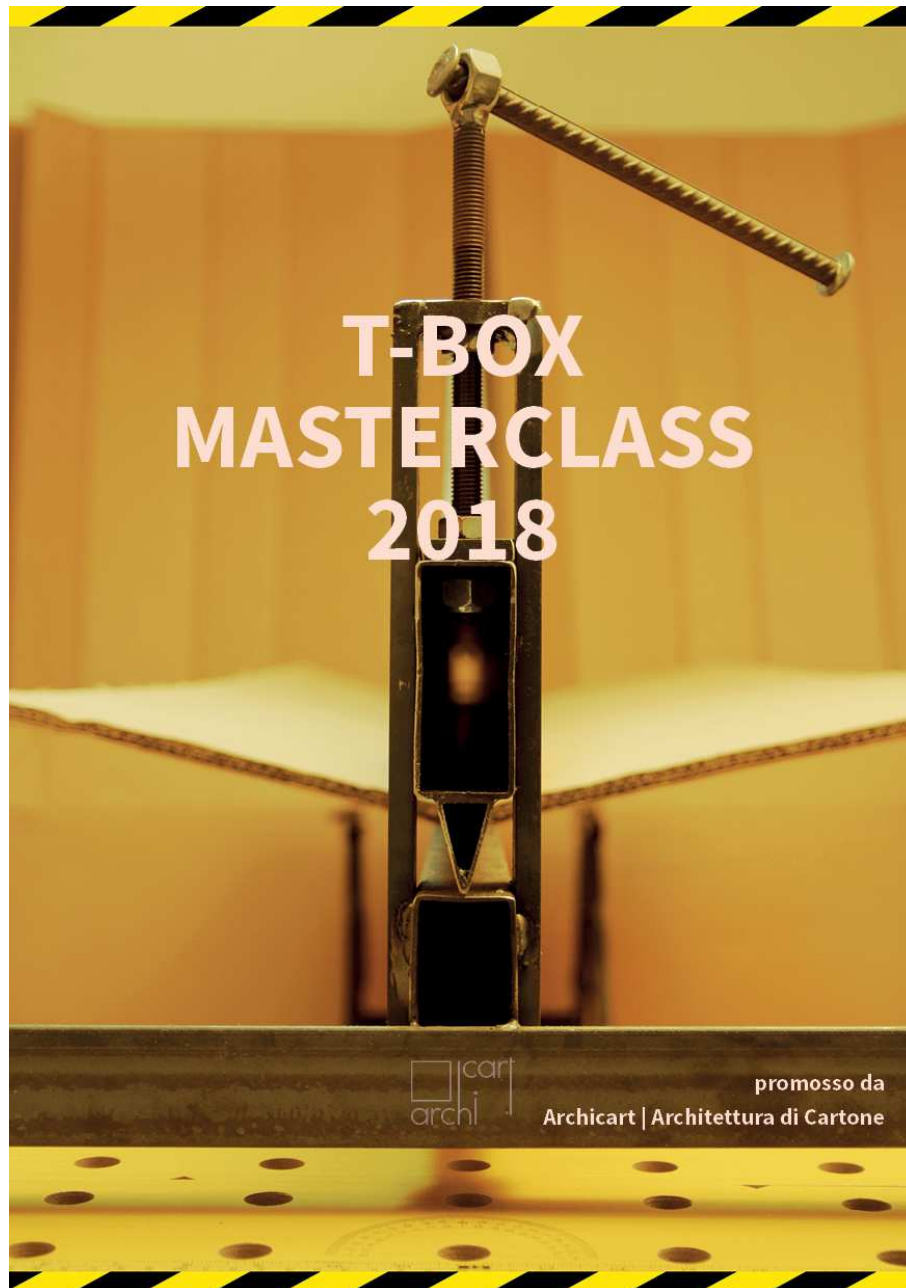

### Obtaining authorization

The competent bodies involved in the decision of approving the T-Box prototyping and the T-Box masterclass are two: Area of Design, Building Development and Maintenance (APSEMa) and the Risk Prevention and Protection Service (SPPR) both administrative bodies of the University of Catania.

In order to approve the request of prototype installation, the APSEMa needs an approximate load analysis to verify the capacity of the roof slab of the technical room designated as installation site.

name	type	unit weight [kg]	quantity	weight [kg]
PACO 120	h250 cm	85	16	1.360
PACO 120	h220 cm	75	8	600
PACO 120	h380 cm	115	3	345
PACO 100	h320 cm	80	4	320
Wood beams	10×10cm	17	10	170
OSB 25mm	thk 25mm	45	4	180
OSB 18mm	thk 18mm	32	4	128
Concrete blocks	50×50×6	30	25	750
Accessories				200
<b>total</b>				<b>4.053</b>

Table 27 / Overview of the T-Box's components weights

It could be considered that the total load of 4.053 kg is divided by the 25 PP adjustable supports and, in favour of security, that each one transmits the load through 1 m<sup>2</sup> of influence area.

$$Q_u = 4.053 \cdot 25^{-1} = 162 \text{ kg/m}^2 = 1,59 \text{ kN/m}^2 \quad (1)$$

In accord with the Italian Construction technical standards (NTC) the accidental load for an outdoor walkable flat roof is 4,00 kN/m<sup>2</sup>, while for indoor walkable area is 2,00 kN/m<sup>2</sup>.

After installing T-Box the available walkable indoor area will be about  $20\text{m}^2$ . Thus the newest accidental load for T-Box fruition will be

$$Q_a = 2,00 \cdot 20 \cdot 25^{-1} = 1,60 \text{ kN} \quad (2)$$

The total load per square meter becomes:

$$Q_T = Q_u + Q_a = 1,59 + 1,60 = 3,19 \text{ kN} < 4,00 \text{ kN} \quad (3)$$

Thus, the accidental load is lower than the load capacity of the roof slab.

In order to fulfil the safety obligations of Italian Law n° 81/2008, a risk assessment document has been prepared regarding the activities that students would carry out during the workshop.

The risks of the activities are distinguished in:

- activities with load handling risk
- activities with physical agent risk
- activities with chemical agent risk

These three types of risks related to the workshop activities need the fulfilment of the following conditions requested by the SPPR:

- visit by the competent doctor (MC) for all workshop participants
- 8h of classroom basic course on safety
- 8h of factory advanced course on safety.

### Involving partners and sponsors

The project to build a real scale prototype must include strategies for fundraising the costs and for increasing the technical knowhow of experts. The idea is to involve locally some sponsor companies that could provide both their knowhow and their ground-breaking technologies through their national providers.

- alveolar cardboard panels: Archicart (main partner and coordinator

of T-Box masterclass)

- insulating material and cardboard outer treatments: Tecnova Group
- external textile coating and supports: Stiltenda
- windows and metal accessories: Flli Lombardo
- cardboard furniture: Format
- PV modules: Solbian and battery storage: progetto ERiC.

### Timeline of prototyping

The programme of the production phases both off-site and on-site is organized by dividing the students into groups and by entrusting them with specific tasks.

T-Box masterclass Buildbox

- Off-site operations: Starting on 25<sup>th</sup> May
  - 1<sup>st</sup> days, group C: making panels
  - 2<sup>nd</sup> days, group B: making panels + making nodes
  - 3<sup>rd</sup> days, group D: making panels
  - 4<sup>th</sup> days, group A: making wooden boards
  - 5<sup>th</sup> days, group C: making wooden boards
  - 6<sup>th</sup> days, group E: making treatments
- On-site operations: Starting on 18<sup>th</sup> June
  - 1<sup>st</sup> week: building foundation base
  - 2<sup>nd</sup> week: insufflation, assembly and installation of panels
  - 3<sup>rd</sup> week: insufflation, assembly and installation of panels
  - 4<sup>th</sup> week: ending installation of panels and installation of coating.

### Building the prototype

The next pages relate to the chronicle of the prototyping of T-Box, build thanks to 1000 screws - 35 degrees - 31 students and 31 cardboard panels - 10 experts - 3 professors - 2 months - 1 Ph.D. research.



Figure 179/ Production of PACO 120 h380 cm - Off-site - Archicart Area srl, Giarre (CT)



Figure 180/ Production of PACO 120 h380 cm - Off-site - Archicart Area srl, Giarre (CT)



Figure 181/ Production of PACO 120 h320 cm - Off-site - Archicart Area srl, Giarre (CT)



Figure 182/ Production of PACO's wooden boards - Off-site - Archicart Area srl, Giarre (CT)



Figure 183/ Production of PACO's wooden boards - Off-site - Archicart Area srl, Giarre (CT)





Figure 184/ Base footprint tracing and positioning of concrete blocks - On-site - University Campus, Catania (CT)



Figure 185/ Adjustment of supports and fixing of wooden beams - On-site - University Campus, Catania (CT)



Figure 186/ Fixing of OSB boards - On-site - University Campus, Catania (CT)

Figure 187/ Installation of breathable membrane - On-site - University Campus, Catania (CT)



Figure 188/ Cellulose fibre blowing - On-site - University Campus, Catania (CT)



Figure 189/ Closing the panels with wooden boards - On-site - University Campus, Catania (CT)



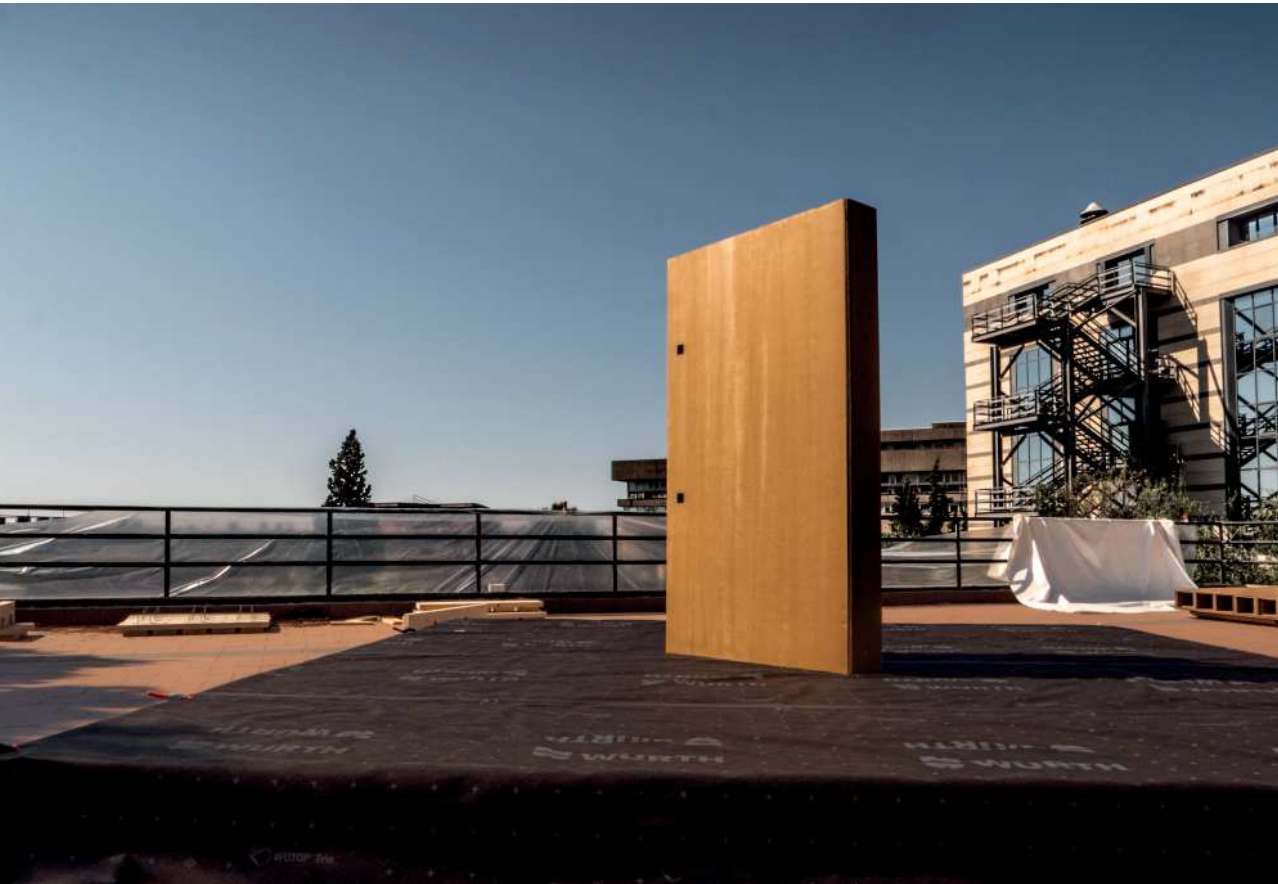

Figure 190 / PACO 120 h220 cm ready to be filled by cellulose fibre - On-site - University Campus, Catania (CT)

Figure 191 / Assembly of flooring layer of PACO 120 h220 cm - On-site - University Campus, Catania (CT)



Figure 192 / Installation of vapour control membrane - On-site - University Campus, Catania (CT)



Figure 193 / Assembly of North front by jointing of 2 panels PACO 120 h380 cm and 2 panels PACO 100 h320 cm - On-site - University Campus, Catania (CT)







Figure 194/ Assembly of roof panels PACO 120 h250 cm by wooden joints and galvanized steel angular - On-site - University Campus, Catania (CT)



Figure 195/ Assembly of roof panels PACO 120 h250 cm by wooden joints and galvanized steel angular - On-site - University Campus, Catania (CT)

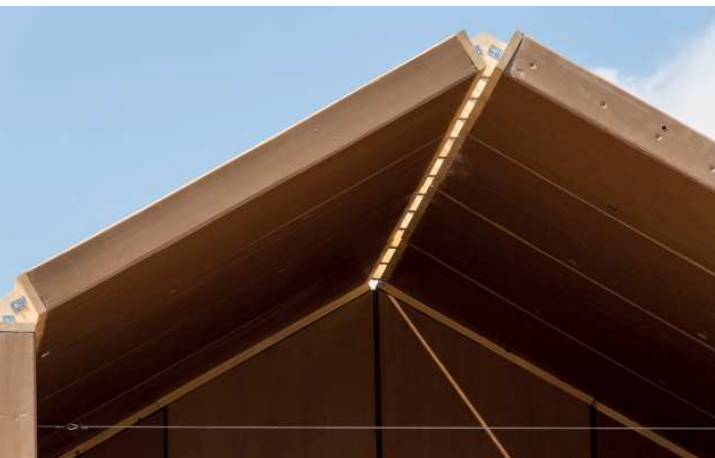

Figure 196/ Detail of the ridge connection - On-site - University Campus, Catania (CT)



Figure 197/ Detail of the gutter connection - On-site - University Campus, Catania (CT)

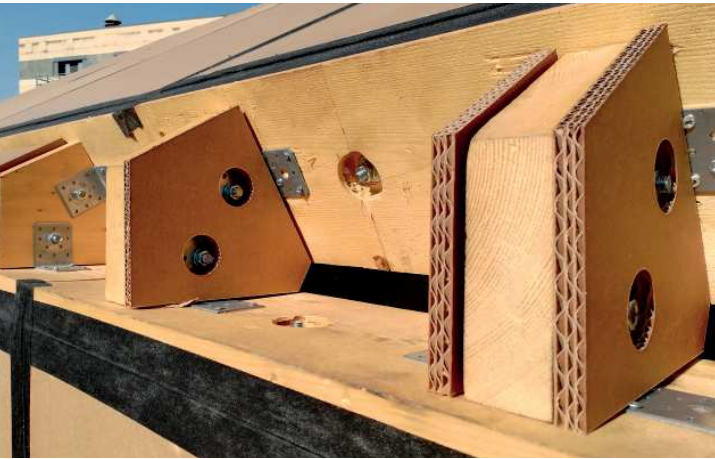

Figure 198 / Preparation of installation of the insulating tube-shaped corrugated cardboard profiles between the wooden joints - On-site - University Campus, Catania (CT)



Figure 199 / Detail of tube-shaped corrugated cardboard profiles - On-site - University Campus, Catania (CT)



Figure 200 / Preparation of the holed galvanized folded steel sheet - On-site - University Campus, Catania (CT)

Figure 201 / Installation of the holed galvanized folded steel sheet and of aluminium profiles - On-site - University Campus, Catania (CT)



Figure 202 / Installation of the PVC textile - On-site - University Campus, Catania (CT)



Figure 203 / Installation of the PVC textile - On-site - University Campus, Catania (CT)





Figure 204 / PVC textile coating - On-site - University Campus, Catania (CT)



Figure 205 / Assembly of the ventilated roof ridge - On-site - University Campus, Catania (CT)



Figure 206 / Installation of window frame - On-site - University Campus, Catania (CT)



Figure 207 / Complete T-Box prototype - University Campus, Catania (CT)

## 6.5 Testing

This phase deals with the measurement of some parameters useful to evaluate the overall quality of the technological structure of the project from the design phase to the prototyping. Testing could reveal that the found solution is wrong or a failure has occurred in the correct definition of the problem.

During this research and at the end of prototyping, the settings of several test campaigns have been defined, for obtaining first results of performance evaluation and also for preparing the ground for the next steps.

In the following part are presented two test campaigns carried out by the students of the second workshop, called Livebox.

### Test campaign

First test campaign is carried out in autumnal period and has the scope of measuring the indoor thermal comfort and the temperatures of internal and external East surfaces.

The thermal comfort is evaluated starting from the measures collected through the DeltaOhm HD32.3 equipped with globe thermometer, dry bulb thermometer with relative humidity probe, and hot wire anemometer.

The surface temperatures are measured through ThermoZig DL01 equipped with two temperature probe for outside and 1 temperature probe matched with 1 heat flow meter for inside.

Figure 208 / In the foreground: HD32.3 equipped with globe thermometer, temperature probe, air flow probe; at left the ThermoZig heat flow meter; on the background the Domino BMS

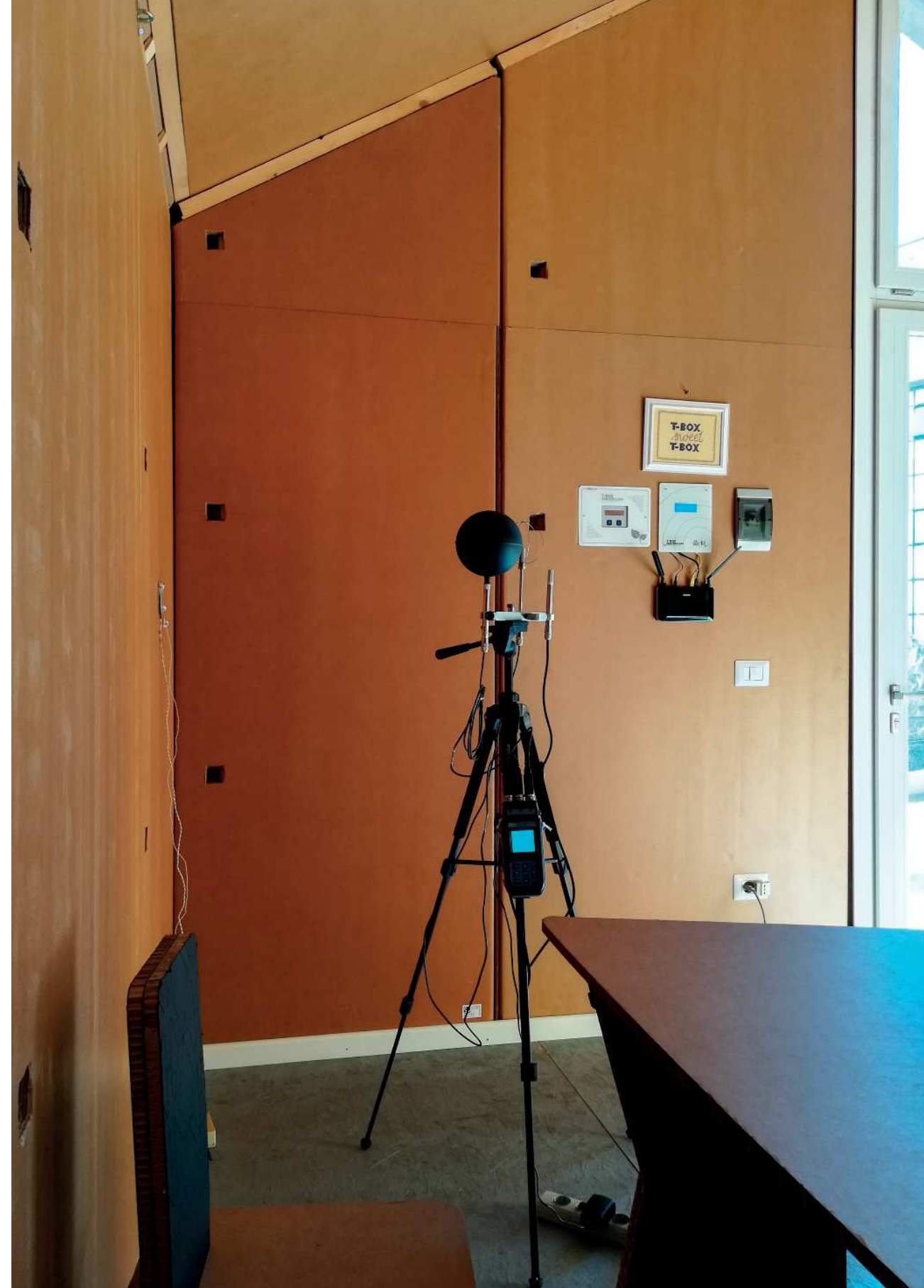

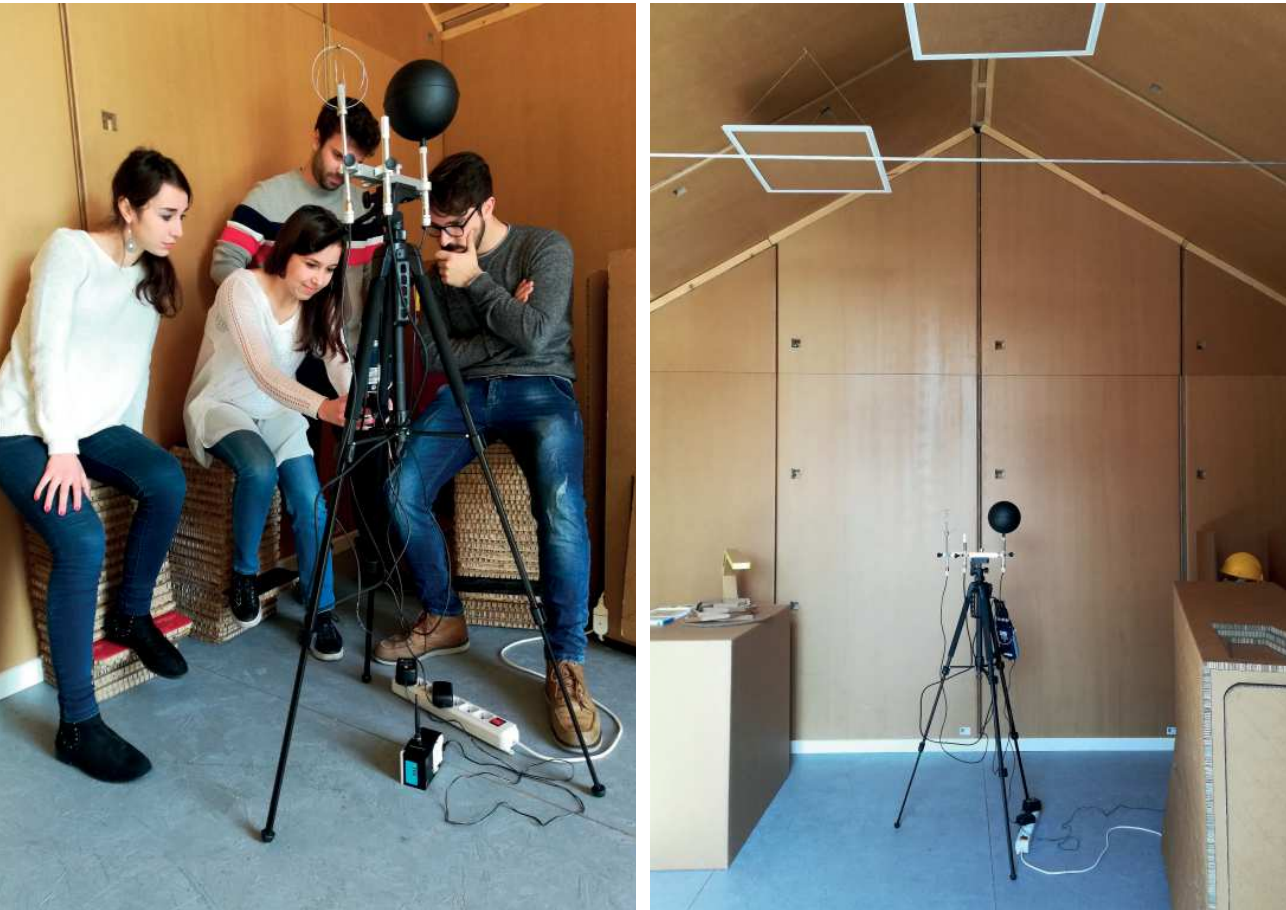

Figure 209 / Livebox's students are setting the HD32.3 equipped with globe thermometer, temperature probe, air flow probe

Footnotes chapter 6

- 1 Doorley et al (2018), p. 1
- 2 Foti M. (1991), pp. 3-8
- 3 Distefano G. (2017), p. 16



## 7/ results

The testing outcomes are analysed and commented in this chapter that precede the conclusions.

## 7.1 What is expected

The end of prototyping phase marks two facts in the developing of the research:

- the achievement of the objective of building in self-construction
- the possibility of beginning with testing phase on the full-scale prototype.

As said in the paragraph 6.2 of the previous chapter, there are at least two direct variables to evaluate between the phase of the implementation of the prototype and the phase of operation.

- Level of self-construction
  - participation
  - cooperation
  - sharing
  - relation.
- Environmental performances
  - thermal comfort
  - thermal performances of the building envelope.

## 7.2 Level of self-construction

The success of the construction process allows to say that it is feasible to build in self-construction an emergency cardboard house-kit, but it needs to quantify the level of self-construction. This level could be evaluated on the base of the average assembly timing deducted from the actual timetable of on-site operations.

At first it is possible to say that the actual timetable is different from the provisional one presented in the paragraph 6.4. The differences are motivated through the following reasons:

- instable weather conditions (rain in June and torrid warm in July)
- adjustments to the executive project
- delays on provide components.

day	month	activities	unskilled workers	experts	common tools	heavy tools	hours
18	June	base tracing	2	2	×		2
19	June	building base	10	2	×		10
20	June	building base	7	1	×		10
21	June	insulation blowing	8	2	×		10
22	June	mounting flooring panels	4	1	×		10
26	June	finishing flooring	8	1	×		10
27	June	finishing flooring	6	1	×		10
3	July	mounting north panels	4	2	×		10
4	July	mounting north panels	6	2	×		10
6	July	mounting west-east panels	4	2	×		10
7	July	mounting west-east panels	4	2	×		10
9	July	mounting roofing panels	2	2	×		10
12	July	mounting roofing panels	2	2	×		10
13	July	mounting south panels	0	2	×		10
17	July	accessorize	0	2	×		10
19	July	accessorize	0	2	×		10
21	July	mounting coating	0	4		×	8
27	July	mounting coating	4	4		×	8
28	July	mounting window	4	2		×	8
31	July	press conference					
<b>tot</b>			<b>68%</b>	<b>32%</b>			<b>176</b>
			<b>unskilled workers</b>	<b>experts</b>			<b>tot</b>
weighted average man/day			4	2			6
average days							22

Table 28 / Report of the constructive phasing of the T-Box prototype

Observing the summary table of the constructive phase, it is possible to state that:

- the percentage of unskilled workers' works hours is 68%
- the average time of T-Box's assembling is 22 days by 4 unskilled workers assisted by 2 specialized ones.

The main objective has been achieved: completing the construction of a brand new housing prototype. Clearly, the prototype condition itself has influenced the progress of the constructive process, that cannot be considered the same as the one of a product already tested and commercialized.

Creating prototypes is more than just the delivery of more solid presentations; it is a highly practical manufacturing strategy. Prototypes provide the best testing models, because they are a physical manifestation of the object and can be tested to find every type of characteristics that could make or break the design.

There are key differences between prototypes and actual objects. Such differences in T-Box prototyping appear in three fundamental ways:

- Materials – T-Box is engineered using many expensive materials and ground-breaking unique solutions.
- Processes – T-Box production was slower, because the production phase itself was subjected to prototyping.
- Actors – T-Box production workers were themselves protagonists of prototyping.

### 7.3 Environmental performances

A full-scale prototype allows to verify the performances simulated by parametric software through suitable measurements. In particular, the parameters that are measured and used for testing the thermal performances of the T-Box are: air temperature, mean radiant temperature, relative humidity, surface temperature and thermal comfort.

#### Period of testing

The actual test period is identified in:

- 7<sup>th</sup> December 2018 at 1:00
- 17<sup>th</sup> December 2018 at 24:00.

#### Simulation

In order to make a comparison between the simulation results and on-site measurements, a faithful model of the T-Box was built on the Rhinoceros platform through Grasshopper 3D and its plugins Honeybee and Ladybug.

The virtual model has the same size of the real one, the same stratigraphy and the same openings size. However, reliable and comparable simulations strongly depend on the availability of the actual weather data to be used as input for the calculation. Most of the building energy simulation engines adopt weather files based on the so-called 'Typical Meteorological Years (TMY)<sup>1</sup>' .

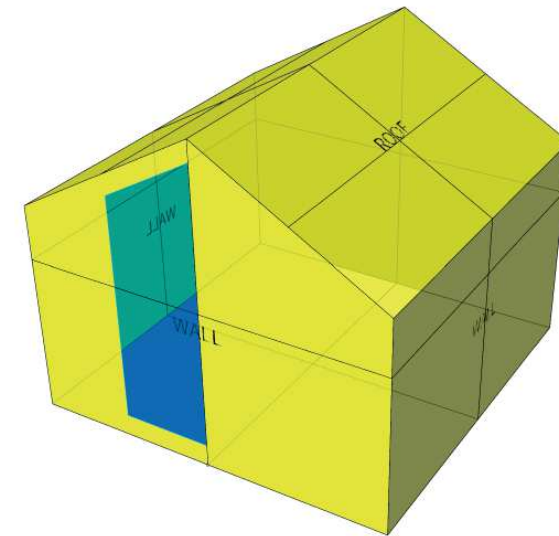

Figure 210 / T-Box virtual model on Rhinoceros viewport

These are generated by statistically averaging long-term weather measurements, issued by weather stations commonly placed in peripheral zones, outside the urban areas. For the area of Catania, the weather file (EPW) available in the EnergyPlus database is the Catania-Fontanarossa-ITA-IGDG-164600, based on statistic data of 2005. In order to adopt the actual environmental data, the idea is to make an alternative EPW file from the environmental data of the meteorological station of the Laboratory of Environmental Technical Physics of the Department of Electrical, Electronics and Computer Engineering.

The data available from the station are:

$$RH [\%] ; T_{air} [^{\circ}C] ; p_a [Pa] ; Dir_{wind} [deg] ; Rad_{dir} [W/m^2] ; Rad_{hor} [W/m^2] ; V_{wind} [m/s] .$$

The data offered with minute precision time-lag, are reported in hourly average and transcribed appropriately in an EPW file. The only data not available on the station is the  $RAD_{diff}$  which is obtained through the  $RAD_{dir}$  values and the angles of inclination of the solar rays at each hour that are known for the particular date.

**Comparison between measurements and simulation data**

The graphs shown on the left represent the comparison of the indoor air temperatures measured by the HP3217R probe ( $T_{a,m}$ ) and the internal air temperature resulting from the Honeybee EnergyPlus simulation ( $T_{a,s}$ ). The same graph shows the values of the outdoor air temperature measured by the meteorological station ( $T_{a,out}$ ) and the wind speed (Swind).

The graphs on the right represent the comparison between the values of the PMV, calculated according to the Fanger formula, on the basis of the values of dry bulb temperature, mean radiant temperature, humidity and wind speed, measured by DeltaOhm HD32.3 ( $PMV_m$ ) and calculated by the Honeybee EnergyPlus simulation ( $PMV_s$ ). These graphs shown also the comparison of the percentage of PPD (measured  $PPD_m$  and simulated  $PPD_s$ ) a percentage of people dissatisfied of 20%, corresponds in Fanger’s scale to: -1,0 slightly cool / +1,0 slightly warm.

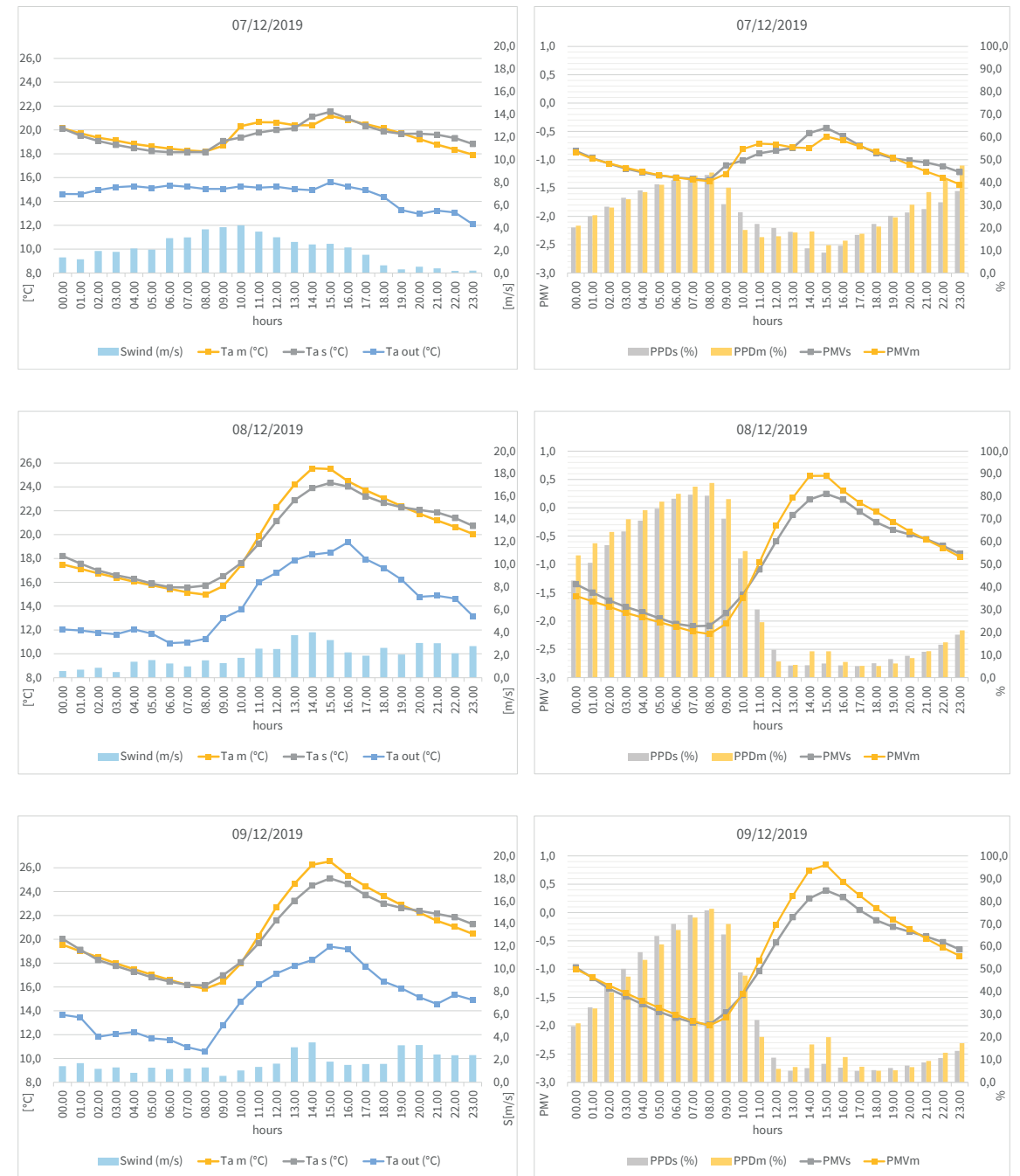

Figure 211/ Comparison of the measured and the simulated temperatures, wind speed

Figure 212/ Comparison of comfort indexes from measurement and simulation, PMV and PPD

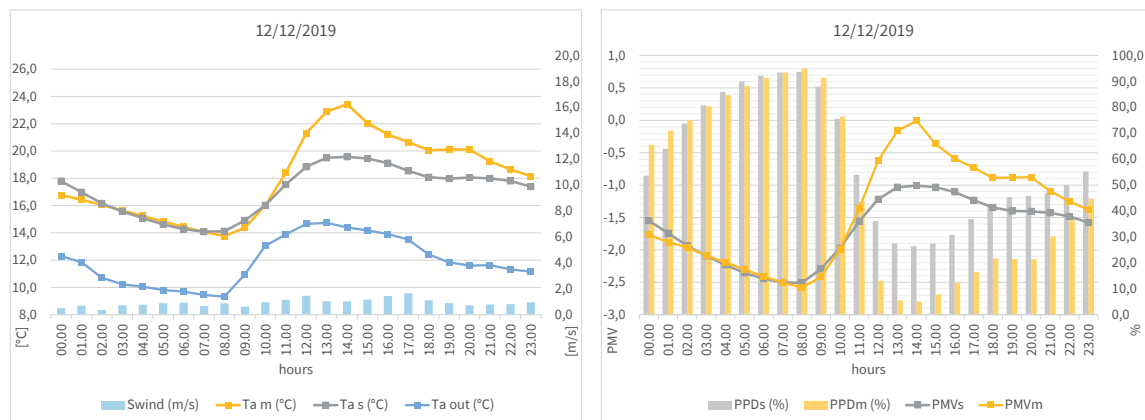
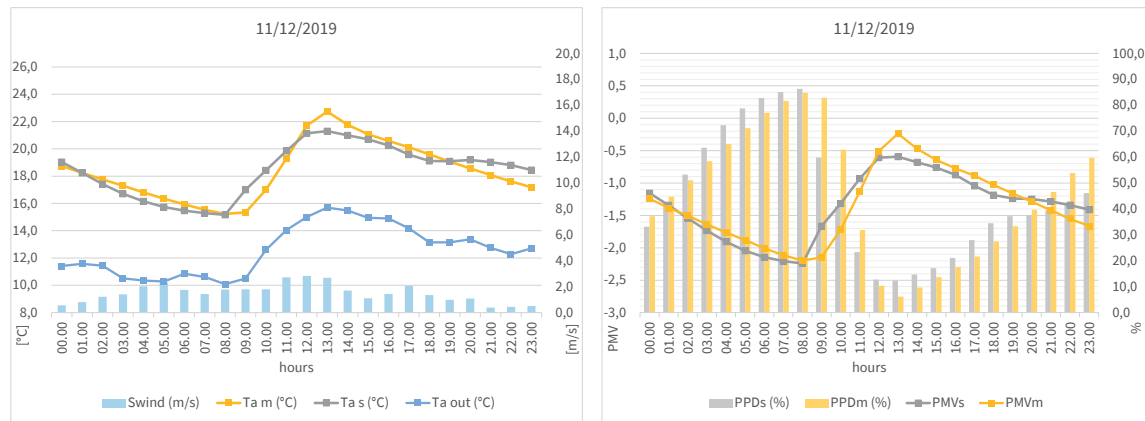
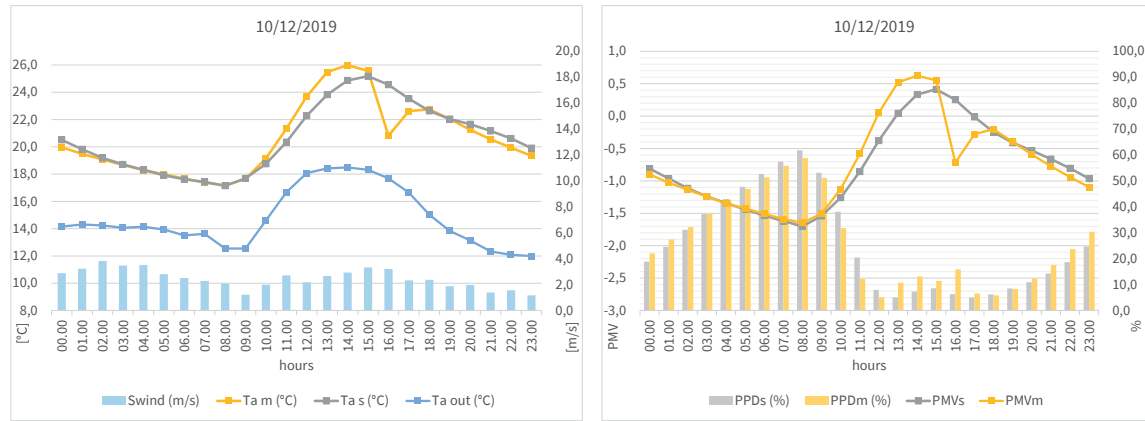

Figure 213 / Comparison of the measured and the simulated temperatures, wind speed

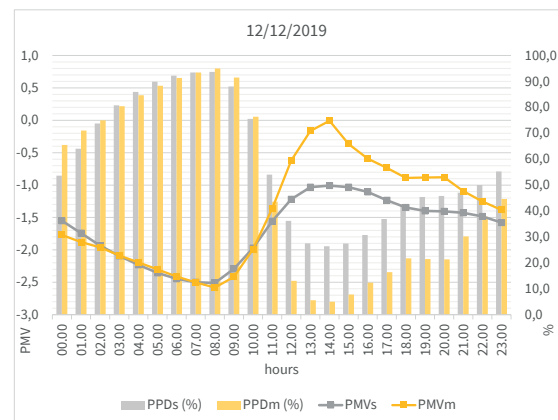

Figure 214 / Comparison of comfort indexes from measurement and simulation, PMV and PPD

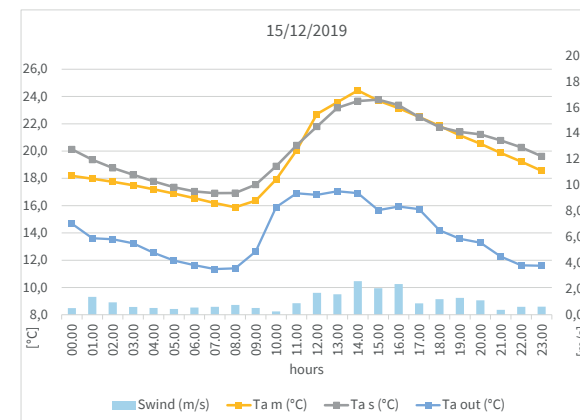
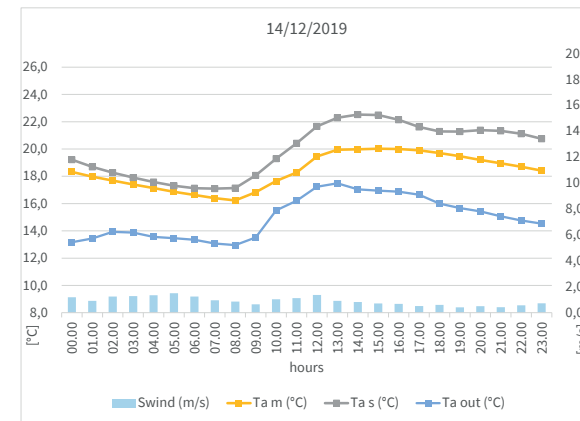
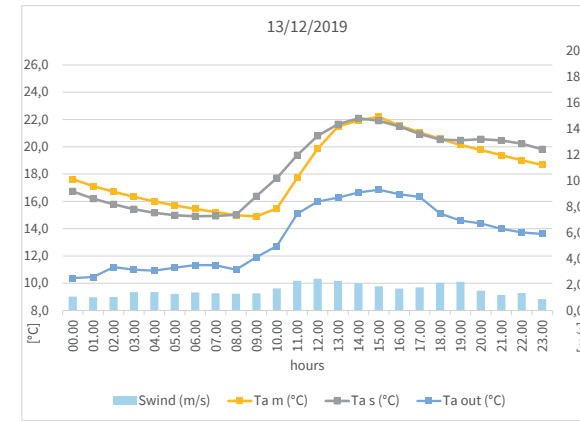

Figure 215 / Comparison of the measured and the simulated temperatures, wind speed

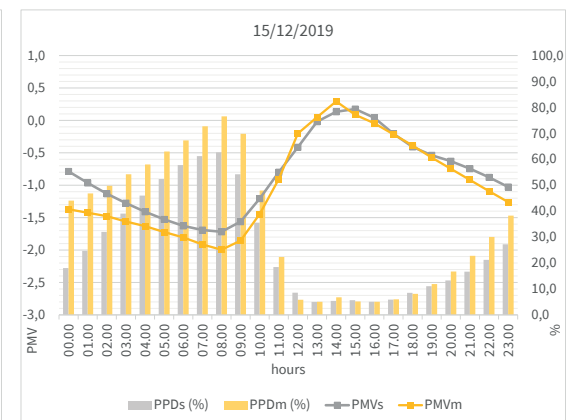
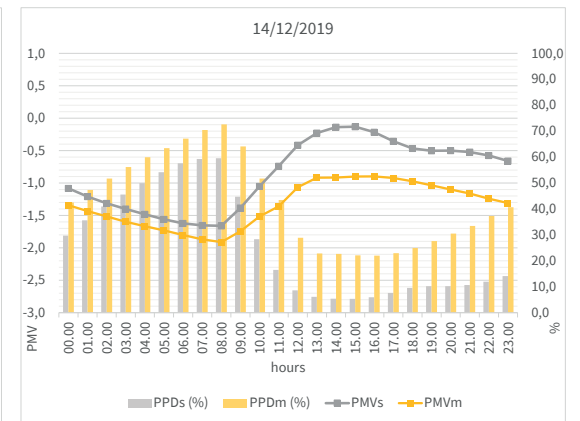
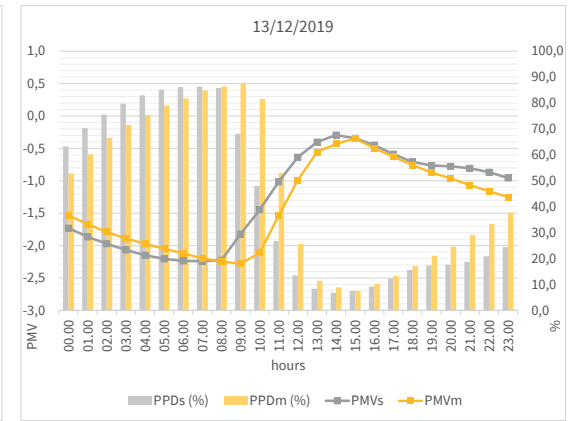

Figure 216 / Comparison of comfort indexes from measurement and simulation, PMV and PPD

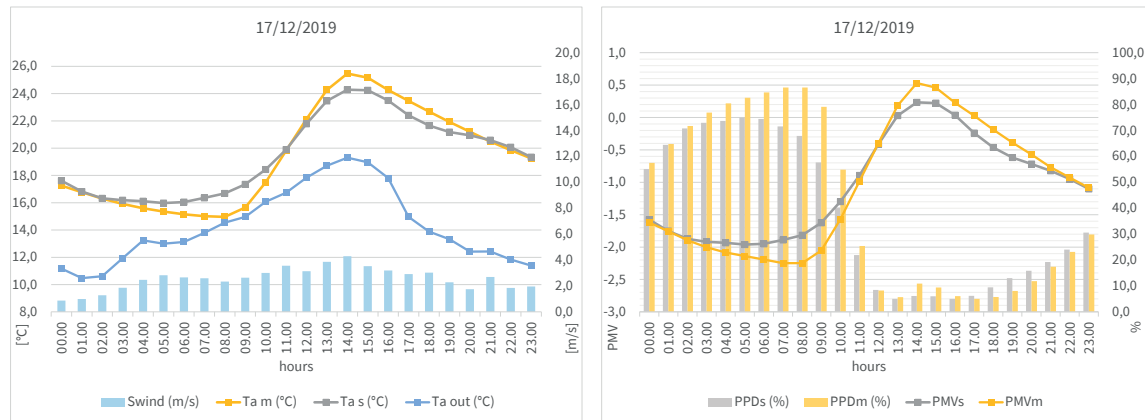
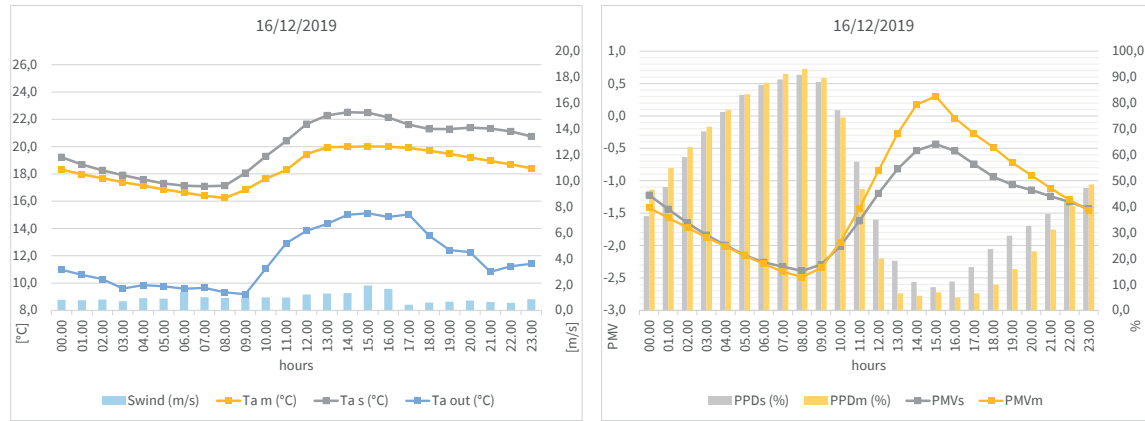

Figure 217 / Comparison of the measured and the simulated temperatures, wind speed

Figure 218 / Comparison of comfort indexes from measurement and simulation, PMV and PPD

*Analysis of the results*

It is possible to observe the good overlapping of the curves of the measured air temperature and of the simulated one. The deviation, even if minimum, can be attributed to the instantaneous variability of the environmental conditions inside the prototype, which simulation does not take into account.

Air temperatures, both measured and simulated, are always above the external air temperature, with deviations ranging between a night minimum of 0,4/2,1°C (measured/simulated) and a maximum day of 9,4/8,8°C (measured/simulated). The good level of daytime comfort is ensured by

the good solar gains coming from the window.

**Surface temperature and Relative Humidity**

The graphs on the left show the comparison between the surfaces temperatures inside and outside the east wall measured with the ThermoZig, certified testing tool ( $T'_{out T}$  and  $T'_{in T}$ ), and with the Domino BMS ( $T_{out A}$  and  $T_{in A}$ ). The graphs on the right show the comparison between the trend of the relative humidity percentage inside and outside the T-Box prototype ( $RH_{in}$  and  $RH_{out}$ ) and the trend of the relative humidity percentage in the east panel in the upper and lower position ( $RH_{top}$  and  $RH_{bot}$ ).

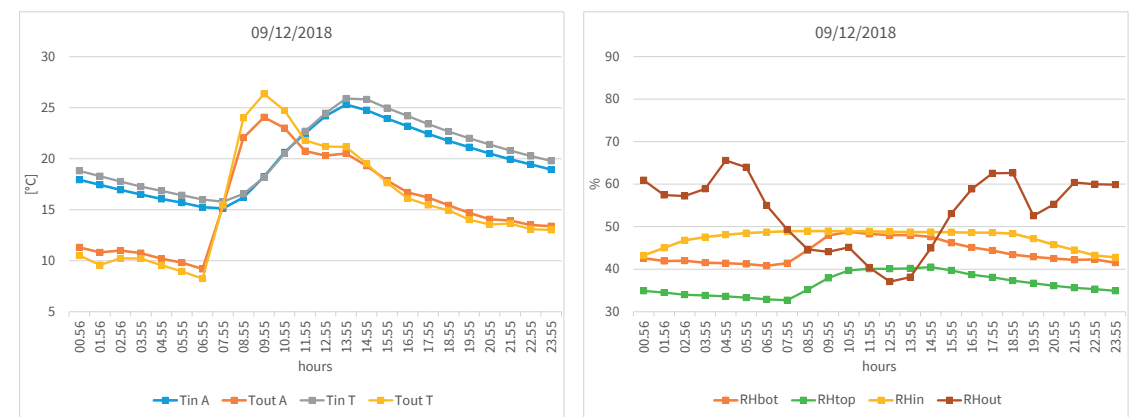
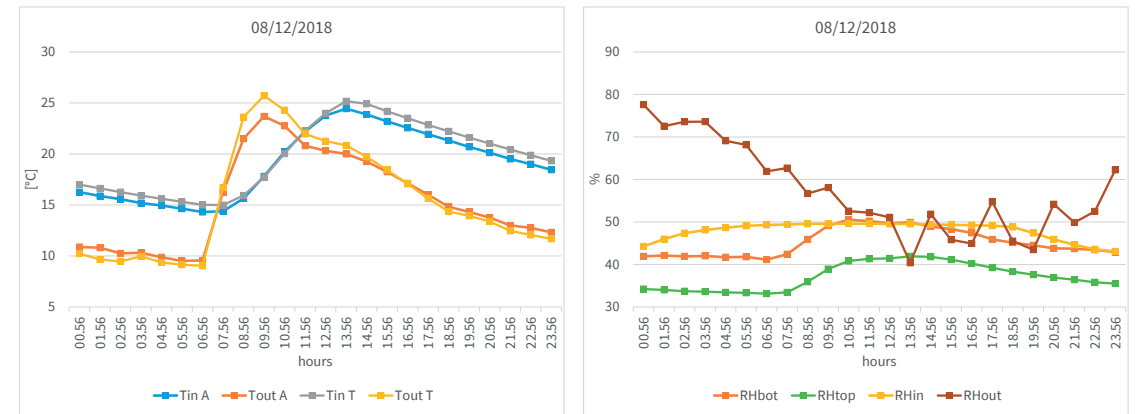

Figure 219 / Comparison of temperatures measured inside and outside with Thermozig and Domino

Figure 220 / Comparison between the trend of the relative humidity percentage inside and outside

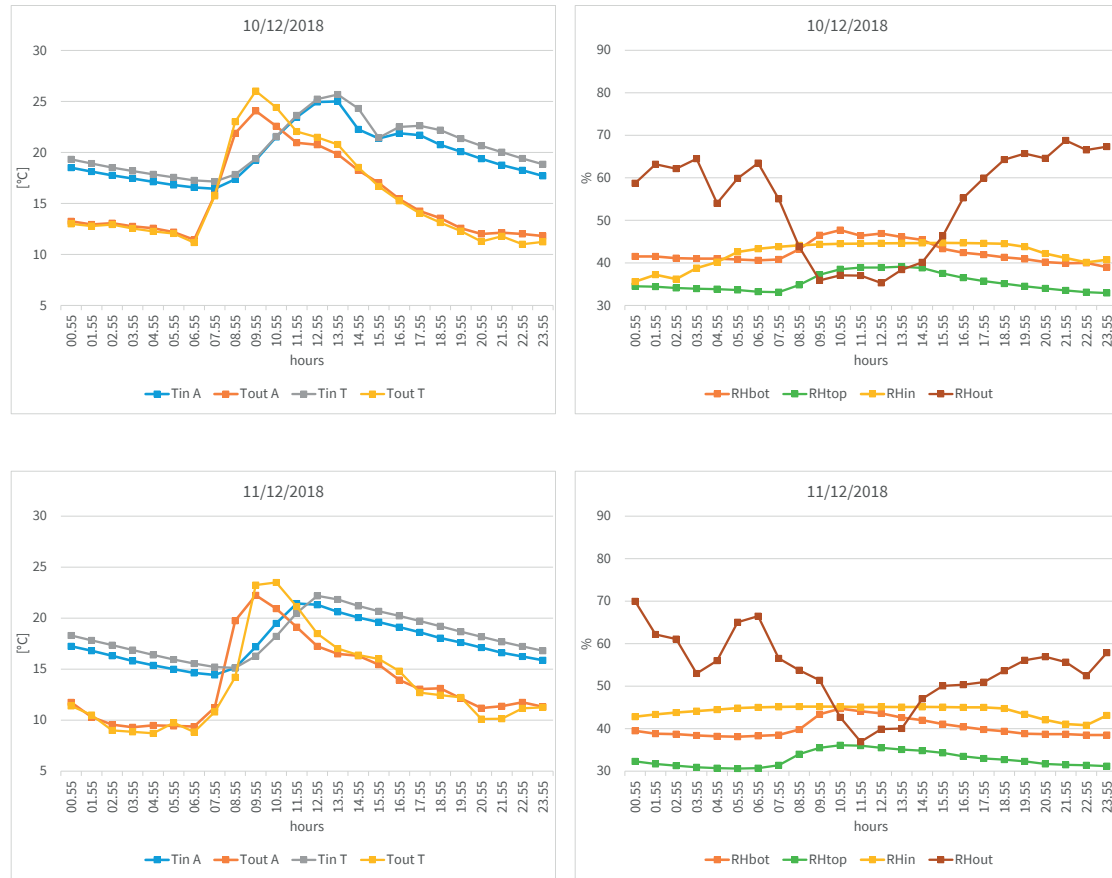

Figure 221 / Comparison of temperatures measured inside and outside with Thermozig and Domino

Figure 222 / Comparison between the trend of the relative humidity percentage inside and outside

peaks in the middle phase of the day. The relative humidity values inside the T-Box are almost constant with slightly variations. The relative humidity inside the east panel equipped with Domino sensors, follows a reverse trend: low percentage of humidity in the night-time phase and higher in the daytime phase, with peak in the central phase of the day. Finally, it is possible to observe in detail how the relative humidity curves inside the PACO East panel have an almost identical trend, but it shifted of about 7-8% in favour of the top of the panel, which has lower values.

Footnotes chapter 7  
1 Evola G. et al. (2018)

*Analysis of results*

It is possible to observe the excellent overlapping of the curves respectively of the internal surface temperatures, measured with Thermozig and with Domino, and of the external ones. This result demonstrates the efficiency of Domino’s open-source measurement equipment based on well-made probes. The second good result is the difference between the internal and the external surface temperatures.

The relative humidity graphs show a trend of higher values of external humidity in the night-time phase and lower in the diurnal phase, with low

## conclusion

The research addresses a very important topic for the contemporary city and society: the housing emergency. Housing emergency is a hot topic, because the social pressures, caused by the need for shelter, generate high levels of risk for the communities.

This work deals with this theme from the global to the specific, starting from speculative considerations, related to the temporary and reversibility feature, to define a complete executive project of a prefabricated housing module for emergency.

The tools that allowed to reach this goal are of three kinds: comparative analysis of the state of the art, the manuals provided by the civil protection bodies, and the parametric bioclimatic strategies.

Each of these tools is a sub-result of the present research. The table of design indexes, made in chapter 3 on the basis of the studies conducted



in chapter 2, offers the bases for the design reflections concerning emergency inhabiting.

The comparative evaluation of the common Italian civil protection solutions (tent, container and S.A.E.), was carried out by: overlapping types of settlements, comparing plan distributions, observing the aesthetic, fitting and living quality characteristics. It has generated the boundaries of the emergency design, and led to the necessity of a new proposal of emergency housing modules that can be assembled and disassembled, and that lie halfway between the tents and the common housing solutions.

The parametric design has allowed to characterize some design variables in order to make the building model repeatable in several climatic conditions.

At this point, the executive design, produced by addressing a search for innovative solutions on the market, is a concrete consequence of the previous phase.

The research process continues with the production moment. The goal of building a full-scale prototype is the validation of theoretical hypothesis: it is possible to build an emergency house-kit made of corrugated cardboard.

The conclusion of the research is the testing moment. Here, all the intuitions and hopes of success could be questioned by the results of on-site measurements. Otherwise, the results of the measurements are absolutely coherent with the expected results produced by the simulations. This last result adds the last piece to the main goal of this research: it is possible to build an emergency house-kit made of corrugated cardboard that is a valid alternative to the common systems in use.

## Bibliography

- Ambasz Emilio, "Italy: the new domestic landscape achievements and problems of Italian design", the Museum of Modern Art, New York Graphic Society, Greenwich, 1972. [www.moma.org/calendar/exhibitions/1783](http://www.moma.org/calendar/exhibitions/1783)
- American Society of Heating, Refrigerating and Air-Conditioning Engineers inc, "ANSI/ASHRAE Standard 55-2004", 2004
- Arendt Hannah, "The human condition", The University of Chicago Press, Chicago, 1998
- Artesi Giambattista, "Esercitazione Basilicata 2012", Presidency of the Council of Ministers, Department of Civil Protection, Potenza, 2012
- Augé Marc, "Nonluoghi introduzione a una antropologia della surmodernità", Elèuthera, Milan, 2009
- Baiocco Giulio, "Ricerca per lo sviluppo di un modulo abitativo di emergenza sostenibile a carattere provvisorio", Ph.D. Thesis, Università degli Studi Roma Tre, 2011
- Bauman Zygmunt, "Modernità liquida", Editori Laterza, Bari, 2002
- Berthier Stéphane, "Timber in the Buildings of Jean Prouvé: an Industrial Material.", *Construction History*, vol. 30, no. 2, 2015, pp. 87–106. JSTOR:[www.jstor.org/stable/44215909](http://www.jstor.org/stable/44215909)
- Bologna Roberto, Terpolilli Carlo, "Emergenza del progetto, progetto dell'emergenza : architetture con-temporaneità", Federico Motta Editore, Milan, 2005
- Cagneschi Claudia, "La costruzione razionale della casa scritti e progetti di Giuseppe Pagano", Ph.D thesis, Alma Mater Studiorum - Università di Bologna, 2009
- Caponetto Rosa, "La valutazione del decadimento prestazionale di componenti edilizi tipici del contesto mediterraneo", Editecnica, Palermo, 2006
- Colombo Joe, Favata Ignazia, "House Environment", Italy: the new domestic landscape, director: Emilio Ambasz, the Museum of Modern Art, release no. 41, New York, 1972
- Conrads Ulrich, "Programs and manifestoes on 20th century architecture", The MIT Press, Cambridge, 1971
- Consip spa, "All.5 Capitolato Tecnico", Open tender procedure, Legislative Decree 163/2006 and modifications, for the supply, transportation and assembly of Emergency Housing Solutions (S.A.E.) and related services, on behalf of the Presidency of the Council of Ministers - Department of Protection Civil - Edition 2
- D'Costa Michael J. , Bartlett F. Michael "Full-scale testing of corrugated fibreboard shelter subjected to static-equivalent wind loads" *Journal of Wind Engineering and Industrial Aerodynamics*, no. 91, Elsevier, 2003. DOI:10.1016/j.jweia.2003.09.016
- Di Carlo Pietro, "La produzione del cartone ondulato", Interregional School of Technology for Paper Technicians, Verona, 2000
- Distefano Dario L., Gagliano Antonio, Naboni Emanuele, Sapienza Vincenzo, Timpanaro Nicola, "Thermophysical characterization of a cardboard emergency kit-house", *Mathematical Modelling of Engineering Problems*, vol. 5, no. 3, 2018, pp. 168-174. DOI:10.18280/mmep.050306
- Distefano Dario, "Architettura di cartone", Degree Thesis, University of Catania, 2014
- Distefano Gianfranco "Domino, Building management system basato su tecnologie open source", Degree Thesis, University of Catania, 2017
- Doorley Scott, Holcomb Sarah, Klebahn Perry, Segovia Kathryn, Utley Jeremy, "Bootcamp bootleg", Institute of Design at Stanford, d.school, 2018. [dschool.stanford.edu/resources/design-thinking-bootleg](http://dschool.stanford.edu/resources/design-thinking-bootleg)
- Drexler Hans, El Khouli Sebastian, "Holistic housing, concepts, Design Strategies and Processes", Edition Detail, Germany, 2012
- Evola Gianpiero, Marletta Luigi, Cimino Damiano, "Weather data morphing to improve building energy modeling in an urban context", *Mathematical Modelling of Engineering Problems*, Vol. 5, No. 3, 2018, pp. 211-216. DOI:10.18280/mmep.050312
- Faegre Torvald, "Tende: architettura dei nomadi", Dedalo Libri, Bari, 1988
- Fanger Povl O., "Thermal Comfort Analysis and Applications in Environmental Engineering", McGraw-Hill Book Company, New York, 1970
- Finocchiaro Luca, Lobaccaro G. "Bioclimatic Design of Green Buildings. In: Wang R., Zhai X. (eds) *Handbook of Energy Systems in Green Buildings*", Springer, Berlin, Heidelberg

Finocchiaro Luca, Ramaci Roberta, “The use of advanced materials for energy efficiency at the ZEB Living LAB in Trondheim. Environmental performance vs environmental impact” SBE, Tallinn and Helsinki Conference, 2016

Finocchiaro Luca, Tor Helge Dokka, Arild Gustavsen, “+Hytte. a versatile construction system for zero emission buildings”, ZEMCH, International conference, 2012

Foti Massimo, “L’abitabilità per l’uomo negli spazi costruiti”, Levrotto & Bella, Turin, 1977

Foti Massimo, “Progettare per l’autocostruzione”, CLUT, Turin, 1991

Fraser Thomas M., “Relative Habitability of Dwellings, a conceptual view”, *Ekistics*, vol. 27, no. 158, 1969, pp. 15–18. JSTOR: [www.jstor.org/stable/43614701](http://www.jstor.org/stable/43614701)

Fuller Richard B., “Building construction”, United States Patent Office, no. US 2,343,764, The Dymaxion company Inc, Wilmington, 1944

Fuller Richard B., “Prefabricated bathroom”, United States Patent Office, no. US 2,220,482, Phelps Dodge Corporation, New York, 1938

Gambardella Cherubino, “La casa mobile, nomadismo e residenza dall’architettura al disegno industriale”, Electa Napoli, Naples, 1995

Imperiale Alicia, “An american wartime dream: the packaged house system of Konrad Wachsmann and Walter Gropius” ACSA Fall Conference, pp. 39-43, 2012

Internal Displacement Monitoring Centre (IDMC), “Mid-year figures”, ed. 20th September 2018, Geneva, Switzerland, 2018

King Geoffrey L., “Miniature antique maps”, online edition, 2013

Kottek Markus, Grieser Jürgen, Beck Christoph, Rudolf Bruno, Rubel Franz, “World Map of the Köppen-Geiger climate classification updated”, *Meteorologische Zeitschrift*, vol. 15, no. 3, 2006, pp. 259-263. [koeppen-geiger.vu-wien.ac.at](http://koeppen-geiger.vu-wien.ac.at)

Mackey Chris, Roudsari Mostapha Sadeghipour, “The Tool(s) Versus The Toolkit”, De Rycke K. et al. (eds) *Humanizing Digital Reality*, pp. 93-101, Springer, Singapore, 2017

McQuaid Matilda “Shigeru Ban”, Phaidon, London, 2003

Negri Emanuele, “Il cartone ondulato e le caratteristiche delle carte per ondulatore”, Interregional School of Technology for Paper Technicians, Verona, 2007

Olgay Victor, “Progettare con il clima, un approccio bioclimatico al regionalismo architettonico”, Franco Muzzio & c. editore, Padova, 1981- first edition “Design with climate, Bioclimatic Approach to Architectural Regionalism”, Princeton University Press, Princeton, 1963

Orehounig Kristina, Mahdavi Ardeshir, “DesignBuilder, Simulation Exercises theory”, USAID-ECOIII: train the trainer Workshop, India, 2010

Porziani Stefano, “Corrugated board containers design methods”, Ph.D. thesis, University of Rome “Tor vergata”, 2011

Prouvé Jean, “Jean Prouvé 8×8 Demountable House, 1944”, Edition Galerie Patrick Seguin, vol. 2, pp. 24-25, 2014

Prouvé Jean, “Jean Prouvé 4×4 Military Shelter, 1939”, Edition Galerie Patrick Seguin, vol. 9, pp. 18-19, 2016

Rizzo Francesco, “Il giudizio di valore”, Aracne Editrice, Rome, 2011

Roselli Alberto, “Mobile House”, Italy: the new domestic landscape, director: Emilio Ambasz, the Museum of Modern Art, release no. 42, New York, 1972

Sacrobosco Johannes De, “Tractatus de Sphaera Mundi”, Excerpt from Johannes de Sacrobosco’s *Tractatus de Sphaera Mundi 1300-1500*, New York Public Library

Soen Dan. “Habitability — Occupants’ Needs and Dwelling Satisfaction.” *Ekistics*, vol. 46, no. 275, 1979, pp. 129–134. JSTOR, [www.jstor.org/stable/43620145](http://www.jstor.org/stable/43620145)

Spampinato Giovanni et al. , “Aree di ammassamento, aree di ricovero, linee guida per la progettazione”, Regional Civil Protection Department, eastern Sicily service, Operating Unit XXII - Civil Protection Planning Unit, 2003

Szokolay Steven V, “Introduction to Architectural Science, the basis of sustainable design”, Architectural Press, Elsevier Science, Oxford, 2004

Touw Katrina, “Firmitas re-visited: Permanence in Contemporary Architecture”, Thesis degree of Master of Architecture in Architecture, University of Waterloo, 2006

Unali Maurizio, “Architettura effimera”, *Enciclopedia Treccani XXI Sec.* , 2010

Vidal Renato, “Modular Living Unit”, United States Patent, no. US 8,997.406 B2, 2015

Vv. Aa., “DOE-2.3, Building Energy Use and Cost Analysis Program”, Lawrence Berkeley National Laboratory James J. Hirsch & Associates, Vol. 4, 2017

Vv. Aa., “Emergency Housing Systems from Three-Dimensional Engineered Fiber-board”, USDA, 2006

Vv. Aa., “Managing construction and rehabilitation projects”, UNHCR Emergency Handbook, UNHCR, 4th edition, 2015. emergency.unhcr.org

Vv. Aa., “Manuale tecnico per l’allestimento delle aree di ricovero per strutture prefabbricate di protezione civile”, Presidency of the Council of Ministers, Department of Civil Protection, Roma, 2005

Vv. Aa., “UNHCR’s Global Shelter and Settlement Strategy, 2014-2018”, UNHCR, 2014

Wachsmann Konrad L., Gropius Walter, “Prefabricated building”, United States Patent Office, no. US 2,355,192, General Panel Corporation, New York, 1944

Zanuso Marco, Sapper Richard, “Mobile Environment”, Italy: the new domestic landscape, director: Emilio Ambasz, the Museum of Modern Art, release no. 37, New York, 1972

alastairgordonwalltowall.com  
archeyes.com  
data.unhcr.org  
daysim.ning.com  
energyplus.net  
inhabitat.com  
richardsapperdesign.com  
wikkellhouse.com  
www.ansa.it  
www.apartmenttherapy.com  
www.archdaily.com  
www.archicart.com  
www.architecture00.net  
www.atlasofinteriors.polimi.it  
www.avpcaugustus.it  
www.bettershelter.org  
www.creativemechanisms.com  
www.designboom.com  
www.designbuilder.co.uk  
www.dezeen.com  
www.hex-house.com  
www.ivalsa.cnr.it  
www.kisho.co.jp  
www.madihome.com

www.moma.org  
www.openstudio.net  
www.patrickseguin.com  
www.peterstutchbury.com.au  
www.popup-house.com  
www.protezionecivile.gov.it  
www.radiance-online.org  
www.shigerubanarchitects.com  
www.thebunkie.com  
www.unhcr.org  
www.uniroma3.it  
www.wikihouse.cc

## Ringrazio

il prof. **Antonio Gagliano**, capace di mantenere ben inquadrato il campo della ricerca e riallineare sapientemente le digressioni che si sono susseguite in questi anni

il prof. **Vincenzo Sapienza** che segue il mio percorso ormai da 10 anni con la stessa amicizia, attenzione e dedizione di sempre

il prof. **Giuseppe Margani** per le nostre collaborazioni che ci hanno permesso di trovare numerose affinità di pensiero e di veduta

il prof. **Massimo Cuomo**, per aver seguito con partecipazione e disponibilità tutte le fasi di questa ricerca ben oltre il ruolo di coordinatore del nostro dottorato di ricerca

il prof. **Enrico Foti**, molto vicino a questo progetto di ricerca, ha creduto da subito alla fase di prototipazione impegnandosi in prima persona affinché avesse compimento, superando le difficoltà burocratiche incontrate

il sig. **Aldo Schilirò**, imprenditore appassionato e fortemente legato al nostro territorio, per l'esempio del suo operato e per la fiducia che continua a infondere in me e in questo progetto

il sig. **Angelo Caruso**, imprenditore dal carattere forte, che puntualmente ha premuto sull'acceleratore spingendomi ad avanzare

il sig. **Carlo Giovanardi**, grande uomo e grande imprenditore, sempre disponibile al confronto nonostante i suoi innumerevoli impegni

il sig. **Giacomo Lombardo**, la sua esperienza ha la stessa densità dell'acciaio che lavora, belli i nostri momenti di confronto

i fratelli **Luca** e **Marco Lombardo**, colleghi e amici, sono i figli di Giacomo che oggi portano avanti il nome dell'azienda di famiglia con estrema dedizione, passione e bravura

il sig. **Salvo Varsallona**, lungimirante imprenditore impegnato nello sviluppo e nella promozione di nuove tecnologie

l'ing. **Pino Perrica**, collega competente, è stato sempre vicino a questo progetto di ricerca dispensando consigli e aiuto

l'ing. **Gianluca Proto**, giovane collega e amico, dedito alla diffusione delle energie rinnovabili sul nostro territorio con idee nuove e potenti

lo studente **Peppino Miranda**, futuro collega, allievo attento e competente, per aver condiviso con me fatiche e soddisfazioni di questo lavoro

l'ing. **Nicola Timpanaro**, collega, socio, amico fraterno, per i nostri incontri-scontri e le nostre convergenze-divergenze, che mi hanno portato a crescere professionalmente e personalmente, non smetto di conoscerlo e la stima che nutro nei suoi confronti continua a crescere

il sig. **Mario Schilirò**, collega, socio, amico fraterno, imperdonabile ritardatario e sfrontato ottimista, la sua vicinanza è irrinunciabile per la simpatia, la bravura, l'attenzione e la passione che mette in ogni cosa che fa, per la certezza che ho nel poter contare sul suo aiuto

e di nuovo **Nicola** e **Mario**, perché ormai certe scelte le posso prendere solo se ascolto il vostro punto di vista, non un consiglio bensì altri occhi per osservare le cose

l'ing. **Raoul Vecchio**, collega e fratello, per il suo esempio di umanità, determinazione e professionalità, spero di riuscire a restituirti una parte di quello che ho appreso stando al tuo fianco

l'ing. **Gianfranco Distefano**, mio fratello, mio socio, mio amico, mio braccio destro, sempre

la prof. **Cinzia Distefano**, mia sorella, per aver corso con me la maratona della scrittura di questa tesi, correggendo centinaia di errori di grammatica e imbarazzanti strafalcioni

i miei **genitori** che nonostante i miei 30 anni continuano a tendermi una mano per aiutarmi a salire

mia nonna **Francesca**, per la sua immensa forza

**Giulia**, mia amica, mia complice, la mia compagna in questa vita, grazie

A/ appendix

simulation charts

# A.1 SsNsSn

	code	South openings	North openings	Shading system
1	SsNsSn	94 cm	94 cm	none

Table 29 / Combination SsNsSn of openings size and shading system

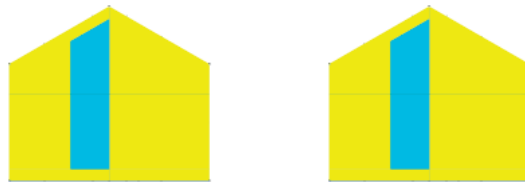

Figure 223 / South front and North front

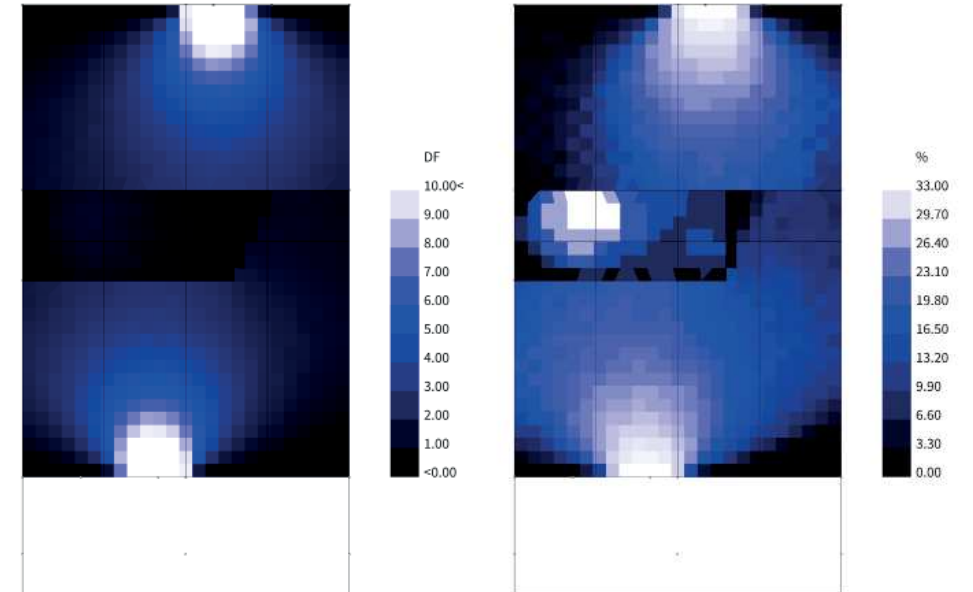
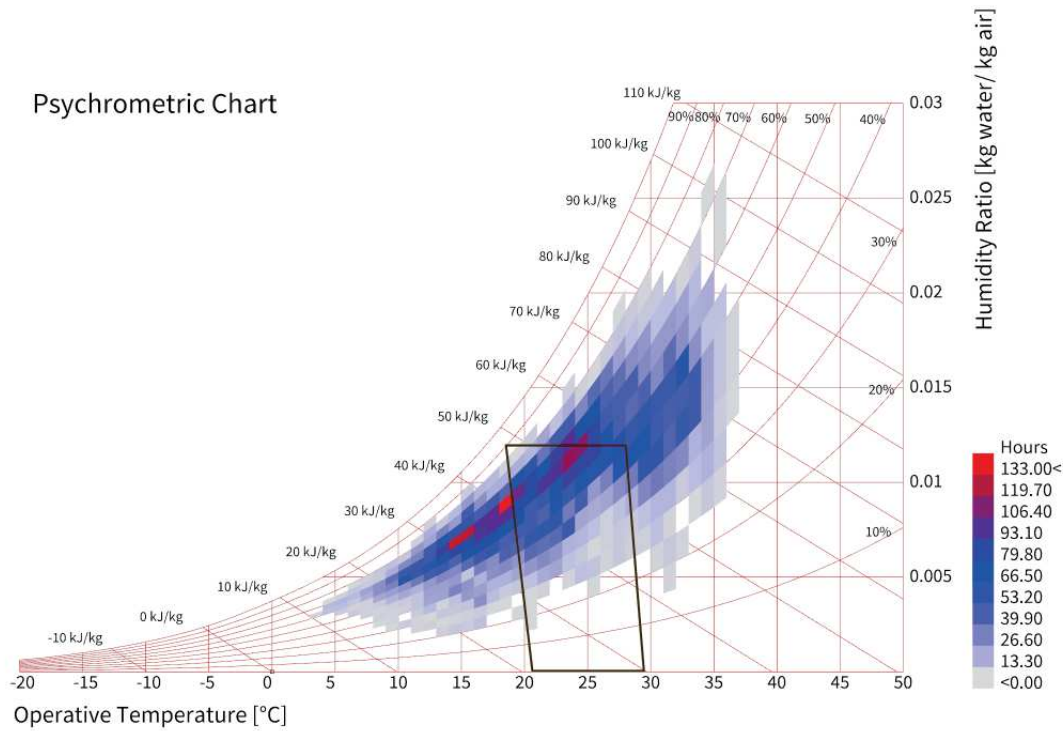

Figure 224 / Output of simulation SsNsSn: ◀ Daylight factor; ▶ Daylight autonomy: percentage of hours of illuminance > than 300lux

## Psychrometric Chart



code	thermal zone	MET	CLO	% hours daylight auto	% hours in comfort	
1.1	SsNsSn	living	1,1	0,5±1.1	49,7	31,7
1.2	SsNsSn	bathroom	1,2	0,5±1.1	49,7	41,9
1.3	SsNsSn	bedroom	0,7	0,5±1.5	50,2	15,7

Table 30 / Results of Daylight simulation and EnergyPlus simulation: percentage of hours of daylight autonomy and percentage of hours in comfort

## A.2 SsNsSs

	code	South openings	North openings	Shading system
2	SsNsSs	94 cm	94 cm	scheduled

Table 31 / Combination SsNsSs of openings size and shading system



Figure 225 / South front and North front

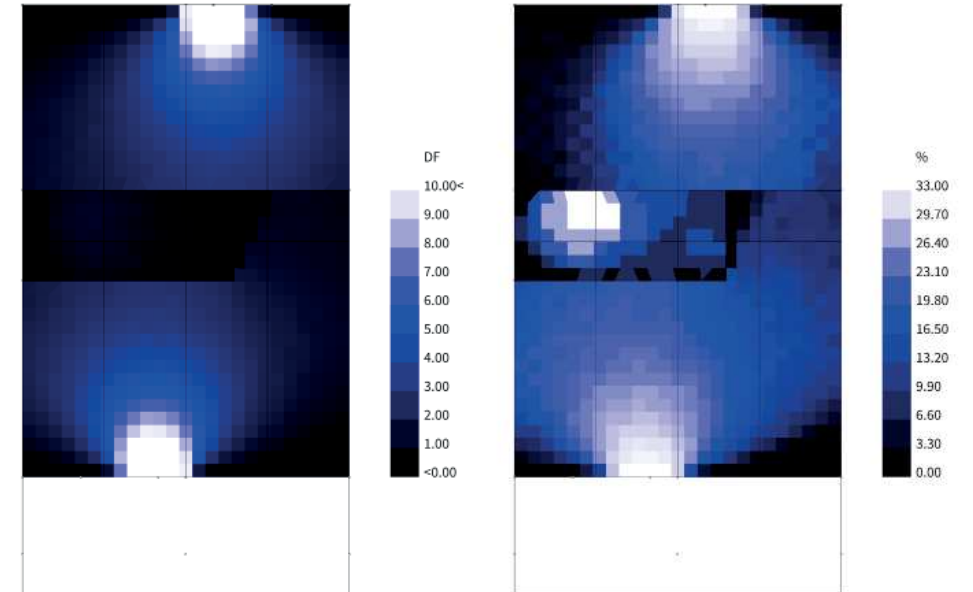
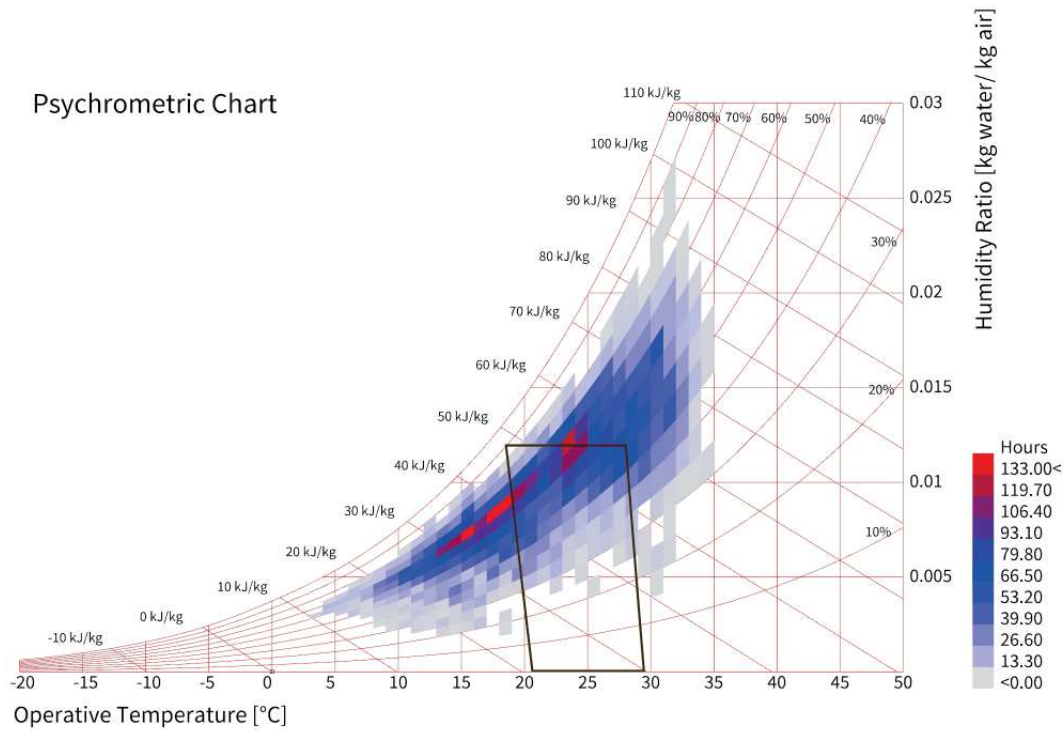

Figure 226 / Output of simulation SsNsSs: ◀ Daylight factor; ▶ Daylight autonomy: percentage of hours of illuminance > than 300lux

### Psychrometric Chart



code	thermal zone	MET	CLO	% hours daylight auto	% hours in comfort	
2.1	SsNsSs	living	1,1	0,5±1.1	49,7	31,1
2.2	SsNsSs	bathroom	1,2	0,5±1.1	49,7	42,0
2.3	SsNsSs	bedroom	0,7	0,5±1.5	50,2	16,1

Table 32 / Results of Daylight simulation and EnergyPlus simulation: percentage of hours of daylight autonomy and percentage of hours in comfort



### A.3 SmNsSn

	code	South openings	North openings	Shading system
3	SmNsSn	115 cm	94 cm	none

Table 33 / Combination SmNsSn of openings size and shading system

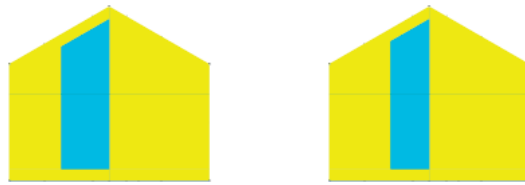

Figure 227 / South front and North front

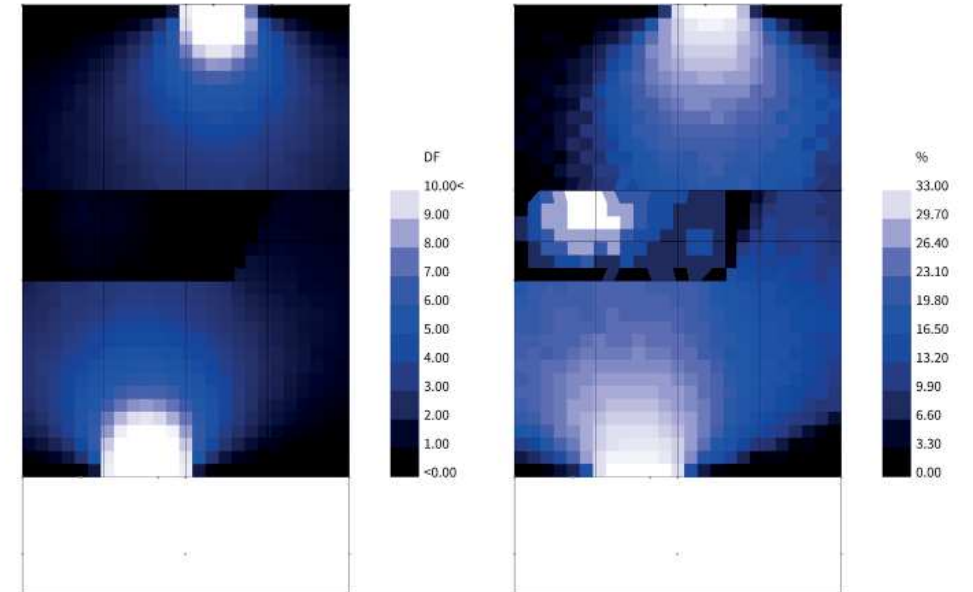
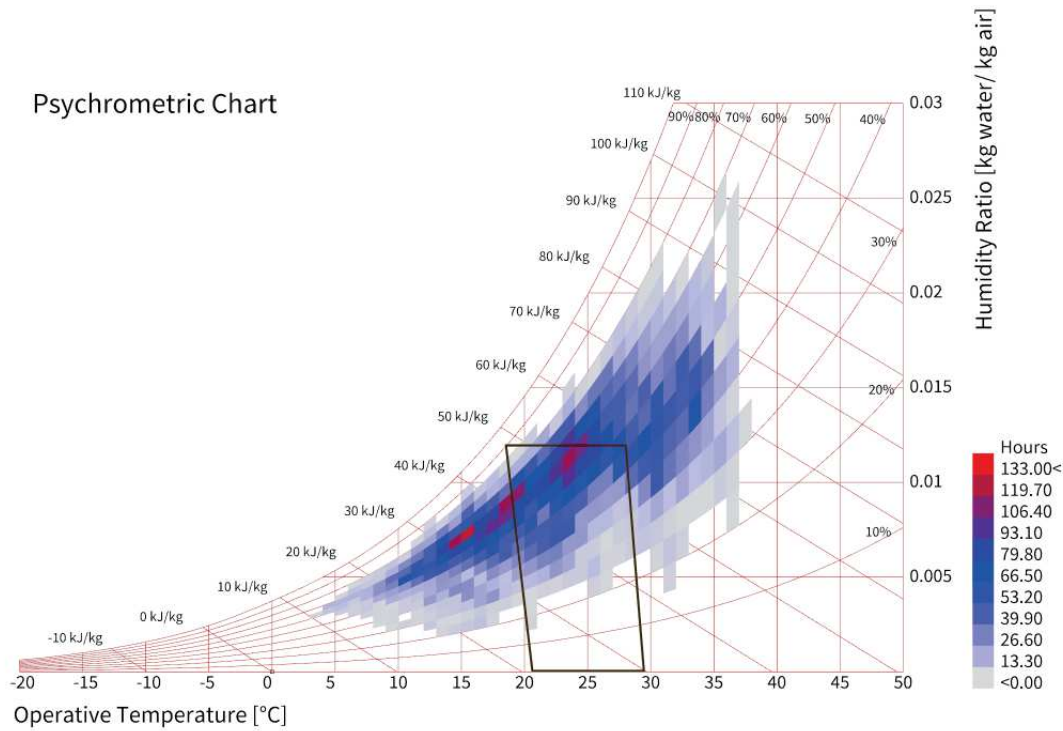

Figure 228 / Output of simulation SmNsSn: ◀ Daylight factor; ▶ Daylight autonomy: percentage of hours of illuminance > than 300lux

#### Psychrometric Chart



code	thermal zone	MET	CLO	% hours daylight auto	% hours in comfort
3.1	SmNsSn living	1,1	0,5±1.1	49,8	32,6
3.2	SmNsSn bathroom	1,2	0,5±1.1	49,6	42,1
3.3	SmNsSn bedroom	0,7	0,5±1.5	50,3	15,6

Table 34 / Results of Daylight simulation and EnergyPlus simulation: percentage of hours of daylight autonomy and percentage of hours in comfort

## A.4 SmNsSs

	code	South openings	North openings	Shading system
4	SmNsSs	115 cm	94 cm	scheduled

Table 35 / Combination SmNsSs of openings size and shading system



Figure 229 / South front and North front

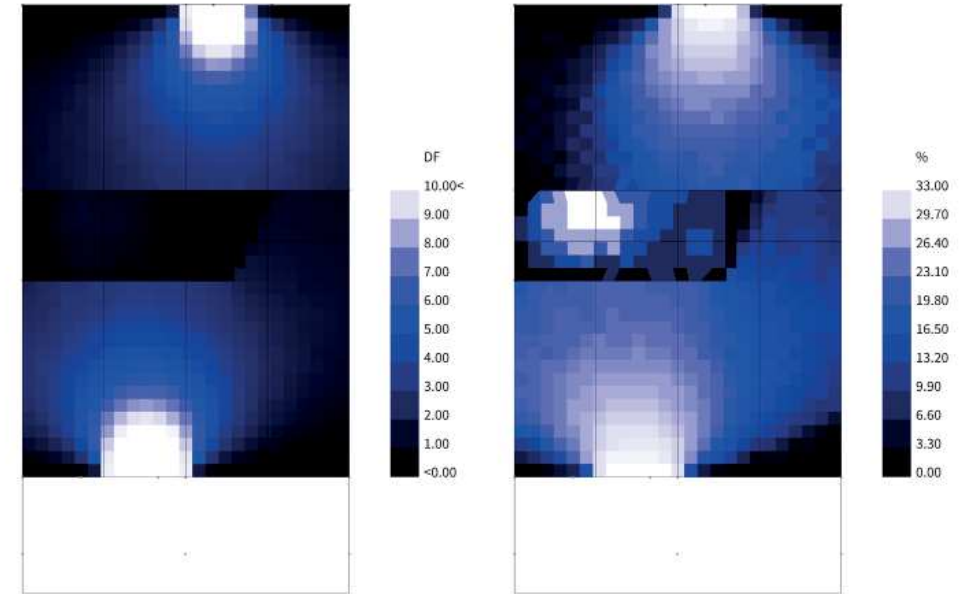
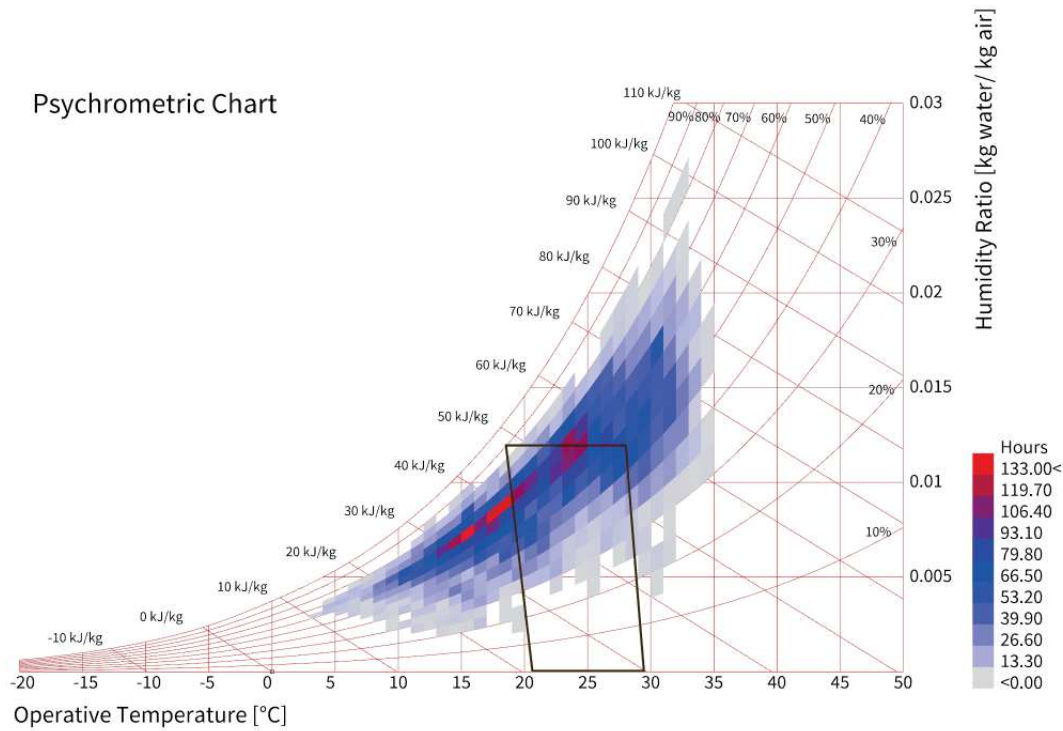

Figure 230 / Output of simulation SmNsSs: ◀ Daylight factor; ▶ Daylight autonomy: percentage of hours of illuminance > than 300lux

### Psychrometric Chart



code	thermal zone	MET	CLO	% hours daylight auto	% hours in comfort	
4.1	SmNsSs	living	1,1	0,5±1.1	49,8	31,6
4.2	SmNsSs	bathroom	1,2	0,5±1.1	49,6	42,2
4.3	SmNsSs	bedroom	0,7	0,5±1.5	50,3	16,1

Table 36 / Results of Daylight simulation and EnergyPlus simulation: percentage of hours of daylight autonomy and percentage of hours in comfort

## A.5 SINmSn

	code	South openings	North openings	Shading system
5	SINmSn	220 cm	115 cm	none

Table 37 / Combination SINsSn of openings size and shading system

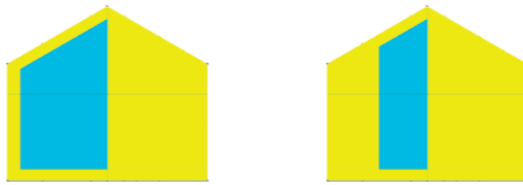

Figure 231 / South front and North front

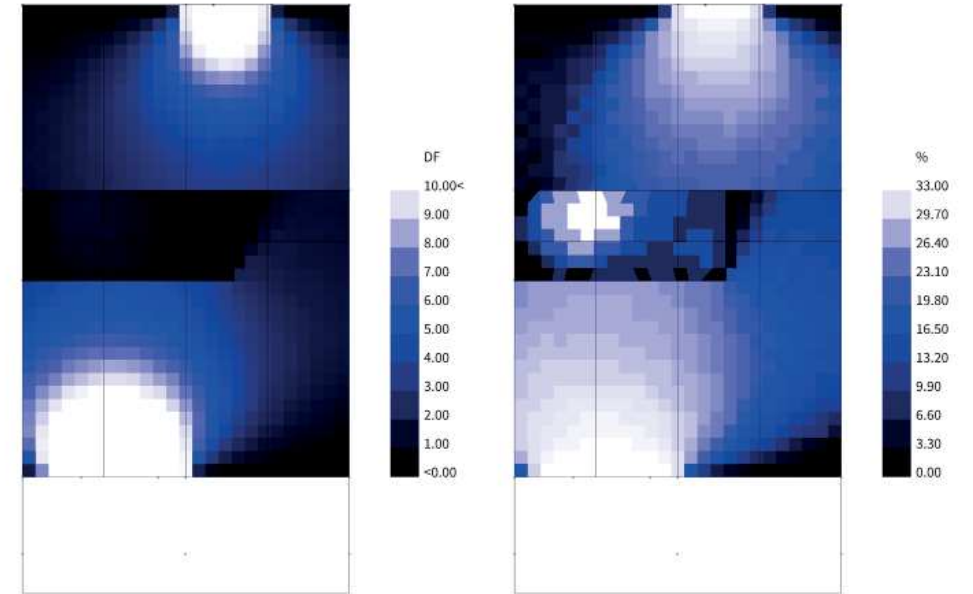
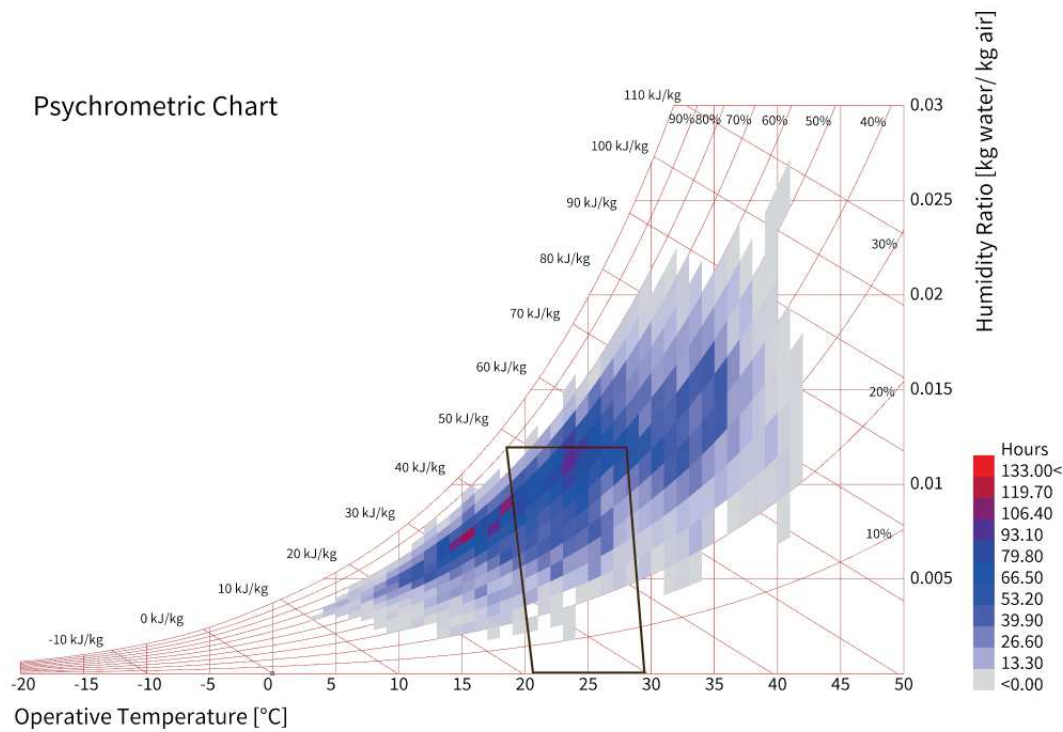

Figure 232 / Output of simulation SINsSn: ◀ Daylight factor; ▶ Daylight autonomy: percentage of hours of illuminance > than 300lux

### Psychrometric Chart



code	thermal zone	MET	CLO	% hours daylight auto	% hours in comfort	
5.1	SINmSn	living	1,1	0,5±1.1	50,2	34,1
5.2	SINmSn	bathroom	1,2	0,5±1.1	50,5	43,3
5.3	SINmSn	bedroom	0,7	0,5±1.5	49,6	15,5

Table 38 / Results of Daylight simulation and EnergyPlus simulation: percentage of hours of daylight autonomy and percentage of hours in comfort

## A.6 SINsSs

	code	South openings	North openings	Shading system
6	SINmSs	220 cm	115 cm	scheduled

Table 39 / Combination SINsSs of openings size and shading system

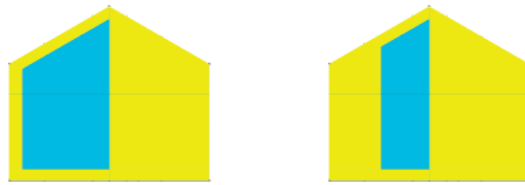

Figure 233 / South front and North front

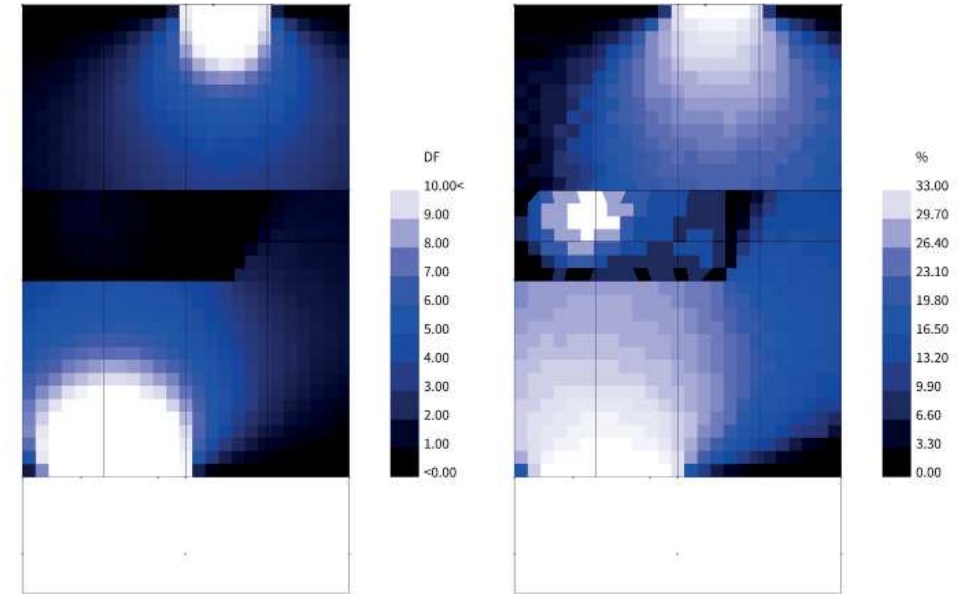
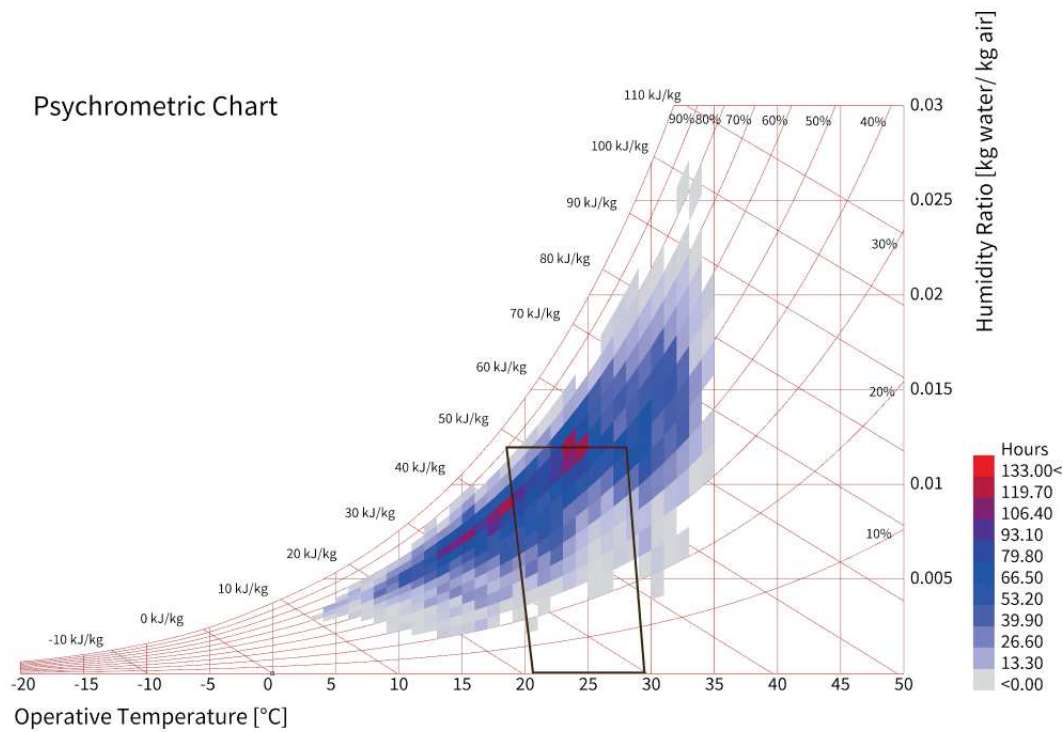

Figure 234 / Output of simulation SINsSs: ◀ Daylight factor; ▶ Daylight autonomy: percentage of hours of illuminance > than 300lux

### Psychrometric Chart



code	thermal zone	MET	CLO	% hours daylight auto	% hours in comfort	
6.1	SINmSs	living	1,1	0,5±1.1	50,2	33,5
6.2	SINmSs	bathroom	1,2	0,5±1.1	50,5	43,1
6.3	SINmSs	bedroom	0,7	0,5±1.5	49,6	15,8

Table 40 / Results of Daylight simulation and EnergyPlus simulation: percentage of hours of daylight autonomy and percentage of hours in comfort

B/ appendix  
datasheets

## B.1 Corrugated cardboard

Name:	<b>EURO 33/14</b>
Producer:	<b>Cartonificio Fiorentino - Progest spa</b>
Sheets:	<b>KSKSKSK</b> <b>K</b> / brown Kraftliner <b>S</b> / Semi-chemical
Weight:	<b>020360360302</b> <b>02</b> / 337g/m <sup>2</sup> <b>03</b> / 180g/m <sup>2</sup> <b>6</b> / 150g/m <sup>2</sup>
Flute:	<b>CCH</b> <b>C</b> / 3,5÷4,4mm <b>H</b> / 4,0÷4,8mm
Thickness:	<b>14mm</b>

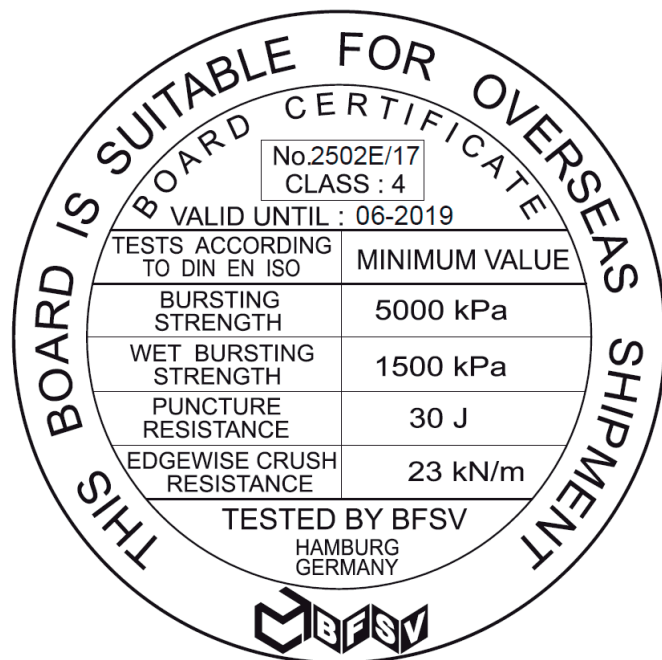

Figure 235 / Test certificate issued by BFSV Verpackungsinstitut Hamburg GmbH to Pro-Gest s.p.a.

## B.2 Cellulose fibre EnerPaper



### Dati tecnici

Caratteristica	Grandezza	
Composizione	Cellulosa	91%
	Fosfato di biammonio	8%
	Solfato di rame	1%
Benestare Tecnico Europeo e controllo	ETA 17/0557 del 26.07.2017	Marcatura CE
Contenuto fibra media (Riciclato)	L >200 micron	> 95 % (1)
Contenuto fibra lunga (Riciclato)	L >1000 micron	> 85 % (1)
Inchiostri di stampa	Esente	
Sali di boro	Esente	
Densità di confezionamento	Kg/m <sup>3</sup>	970
Densità di posa	Kg/m <sup>3</sup>	20-35
Conducibilità termica	UNI EN 12667:2002	0.037 W/mK
Fattore di resistenza al vapore μ	UNI EN 12086:2013	1,5
Reazione al fuoco	UNI EN 13501 - 1:2009	Classe B-s1, d0
Crescita di muffe	EN ISO 846	Grado 0
Stabilità dimensionale	Ottima, il volume resta costante nel tempo	

### Imballaggio

Bobine da 23 kg - dimensioni: H. 15cm x diam. 48cm

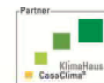

## B.3 PVC textile



### Serge Ferrari Précontraint 502 Satin

CODICE 6336

#### Tipologia

Membrana composta in poliestere spalmato PVC con finitura satinata. Tecnologia esclusiva brevettata Précontraint Serge Ferrari®.

#### Caratteristiche

Membrana con eccezionale stabilità dimensionale e resistenza meccanica. Nuova gamma colori con finitura satin e laccatura in resina acrilica e PVDF per una migliore resistenza allo sporco, agli agenti atmosferici ed una maggiore durata nel tempo. Superficie perfettamente planare, ampia gamma colori. Confezionamento senza rinforzi laterali. Ignifugo.

#### Utilizzi

Ideale per tende da sole, pergole, tettoie, vele ombreggianti, coperture, piccole strutture e gazebo.

#### Applicazioni

Gazebo, Pergole, Strutture fisse, Tende a bracci, Tende per balcone, Vele ombreggianti

#### Specifiche

##### Caratteristiche tecniche

Composizione	PES + PVC coating
Finissaggio	laccato PVDF
<b>Dimensioni</b>	
Filato (ordito)	poliestere 1100 dtex HT
Filato (trama)	poliestere 1100 dtex HT
Peso ISO 2286-2	570 g/m <sup>2</sup>
Spessore	0.43 mm
Altezza rotolo	180 cm
Lunghezza rotolo	40 m
<b>Prestazioni</b>	
Resistenza alla trazione (ordito) ISO 1421-1	200 DaN/5 cm
Resistenza alla trazione (trama) ISO 1421-1	200 DaN/5 cm
Resistenza allo strappo (ordito) DIN 53363	20 DaN
Resistenza allo strappo (trama) DIN 53363	20 DaN
Resistenza al caldo	+70 °C
Resistenza al freddo	-30 °C
Classe di reazione al fuoco	M2 (NF P92.507) - class 2 (UNI 9177) - B1 (DIN 4102) - (BS 7837) - M2 (UNE 23.727) - VKF 5.3 (SN 198898) - (NFPA 701) - (CSFM T19) - class A (ASTM E84)
Adesione ISO 811	7 mm
Euroclasse ISO 811	B-s2-d0 mm

## B.4 Sciuker Frames Skill

### la protezione esterna del legno: la tecnologia legatec overlap thermal profile

La **finestra Skill** è un'esclusiva Sciuker LAB, oggetto di due brevetti. Il primo riguarda la protezione esterna, il secondo il sistema di accoppiamento angolare delle ante. La protezione del legno consiste nell'applicazione termoprofilata di una lamina in lega di alluminio tecnologica (legatec) con un film a base di resina acrilica ad alte prestazioni funzionali sulla parte esterna del legno mediante collanti termostatici isolanti poliuretani, che evita la manutenzione, riduce il riscaldamento del profilo, conserva la sua lucentezza per tutta la durata del prodotto ed è anche antigraffio. (vedi particolare pag.9)

Il sistema di accoppiamento (tenone) angolare delle ante, a 90° all'esterno e 45° all'interno, è unico nel suo genere perché rievoca lo stile delle tradizionali finestre in legno e si integra perfettamente sia nelle nuove costruzioni, sia nelle ristrutturazioni e nei centri storici. (vedi foto nella pagina)

**Skill plus** è la versione triplovetro. Skill e Skill plus garantiscono prestazioni elevate in termini di protezione all'isolamento termico e acustico. (vedi foto nella pagina)

Il valore medio caratteristico della trasmittanza termica del telaio  $U_{fm} = 1,3 \text{ W/m}^2\text{K}$  (Classe B). Quest'ultimo, abbinato ad opportune vetrate, consente di raggiungere:

**a)** con vetro doppio basso emissivo warm edge con  $U_g$  pari a  $1,0 \text{ W/m}^2\text{K}$  un valore di  $U_w$  fino a  $1,23 \text{ W/m}^2\text{K}$

**b)** con un vetro triplo basso emissivo warm edge con  $U_g$  pari a  $0,8$  un  $U_w$  fino a  $1,11 \text{ W/m}^2\text{K}$ . Durante le prove per la marcatura CE l'infisso ha raggiunto la classe E 900 di tenuta all'acqua, classe 4 di tenuta all'aria e classe C5 di resistenza al carico di vento."



accoppiamento esterno brevettato a 90°



accoppiamento interno brevettato a 45°



versione triplovetro

C/ appendix

**T-BOX**  
assembly manual





SAFETY HELMET



EYE PROTECTION



GLOVES



DUST MASK



HEARING PROTECTION



SAFETY FOOTWEAR



SAFETY HARNESSES



KEEP CLEAR



CIRCULAR SAW

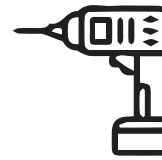

SCREWDRIVER



ANGLE GRINDER



SAW



COPING SAW



HAMMER



RATCHETING  
COMBINATION  
WRENCH

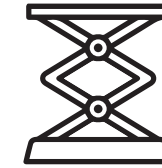

LIFTER

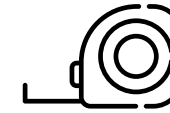

TAPE MEASURE



BUBBLE LEVEL

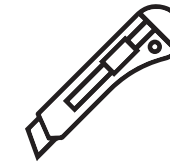

CUTTER

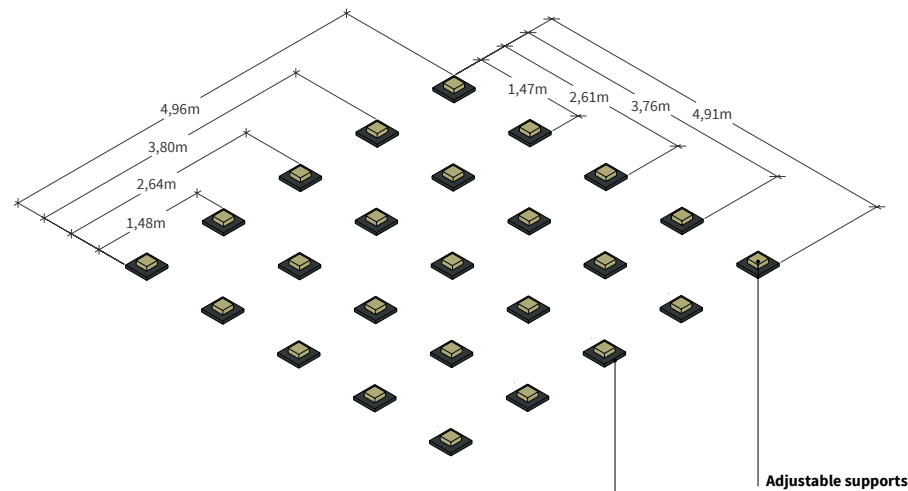

M6 x20



**Concrete blocks**  
weight 30 kg  
2 workers for handling

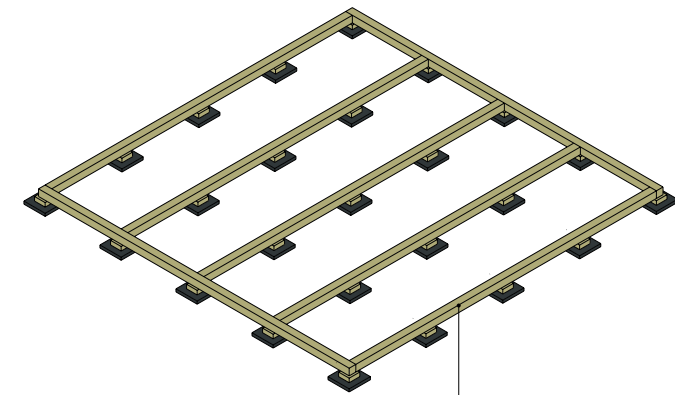

T20 5x50  
T30 8x200

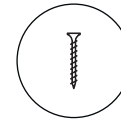

55x70x70

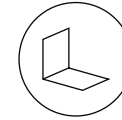

**Wood beam**  
weight 32,5 kg  
2 workers for handling



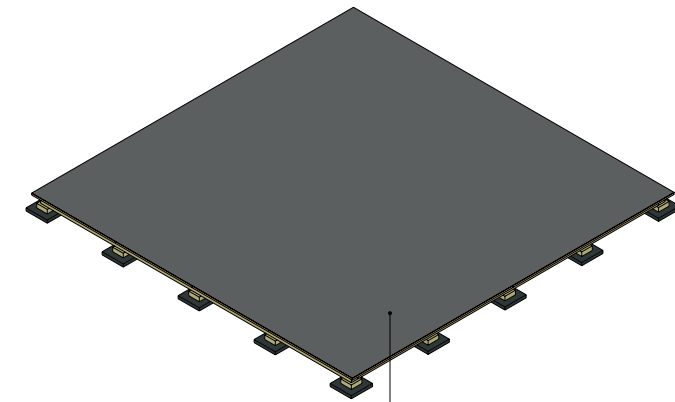
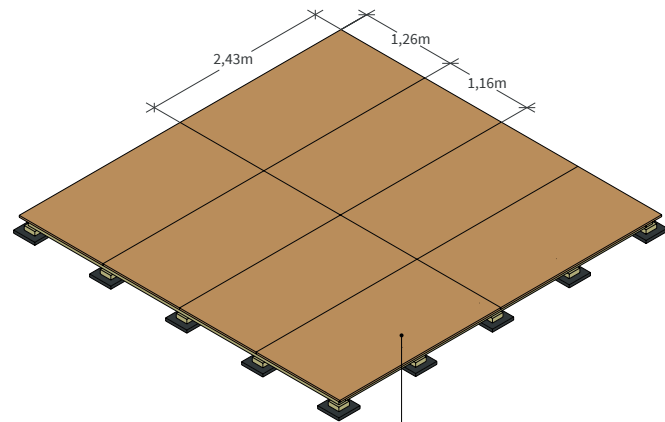
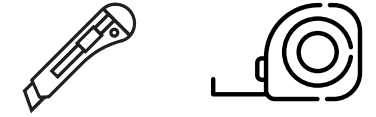

T20 4x50



**OSB 25mm**  
weight 50 kg  
2 workers for handling

BREATHABLE MEMBRANE



AIR SEALING TAPE

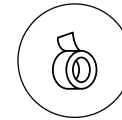

**Breathable membrane**  
10 cm overlapping  
air sealing tape



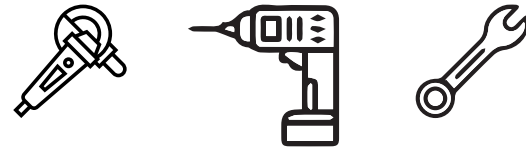

PACO 120 h220  
weight 75 kg  
3 workers for handling

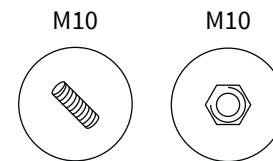
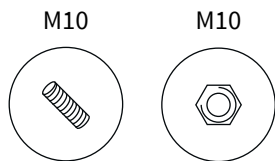
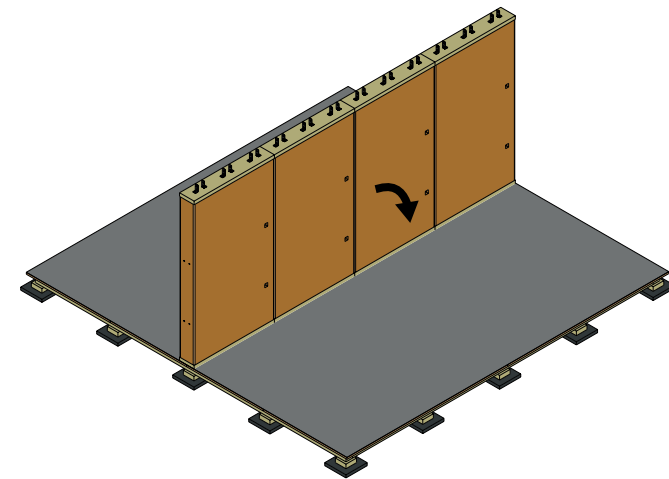
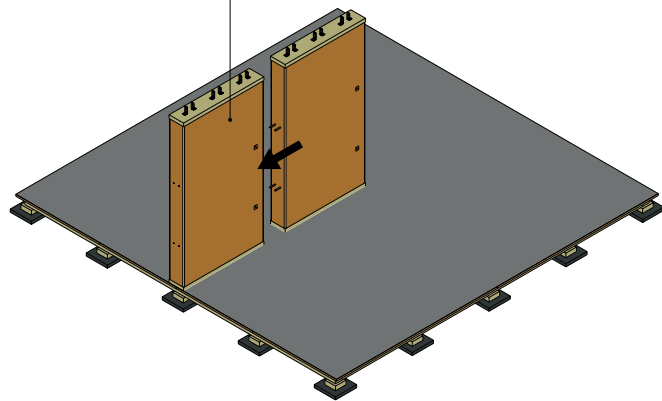

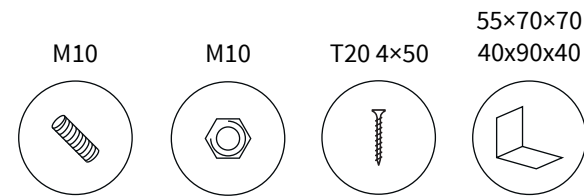
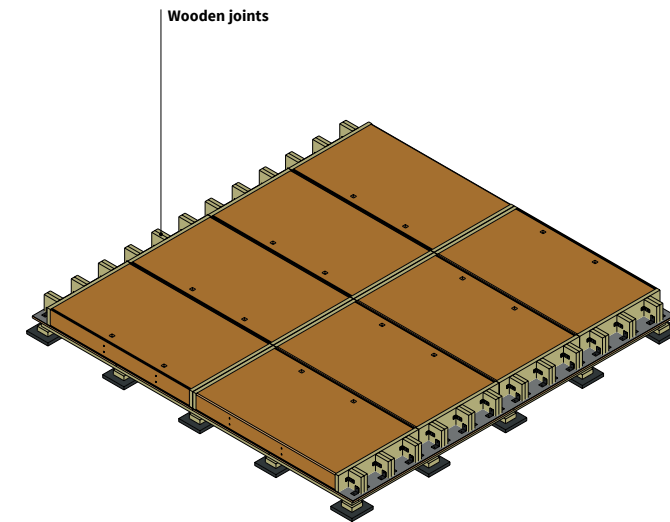
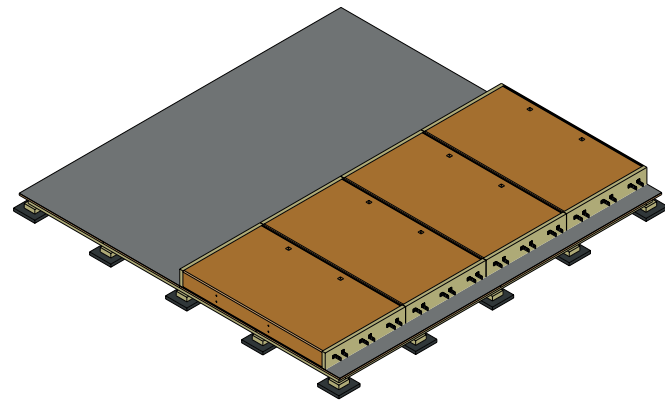
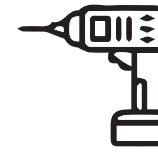

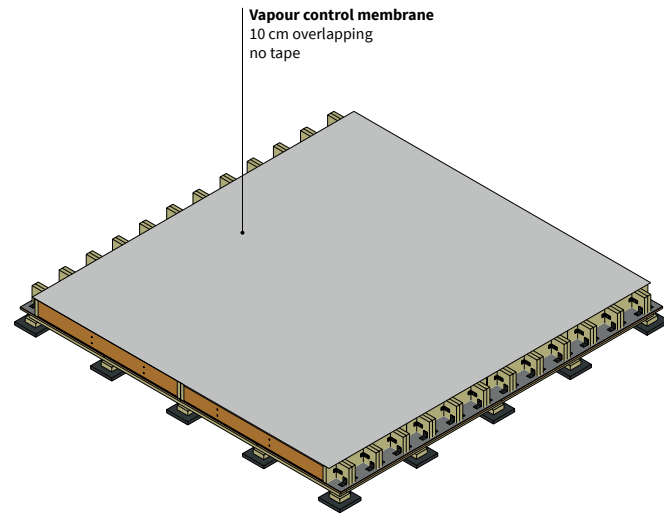

Vapour control membrane  
10 cm overlapping  
no tape

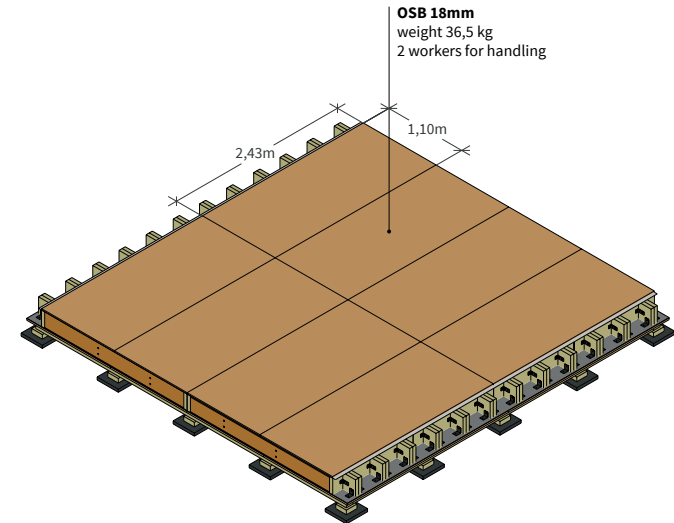

OSB 18mm  
weight 36,5 kg  
2 workers for handling

MEMBRANE



T20 4x50

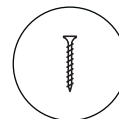

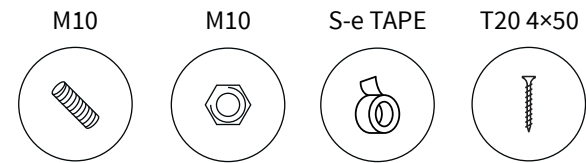
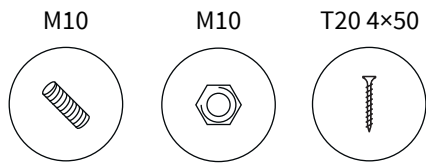
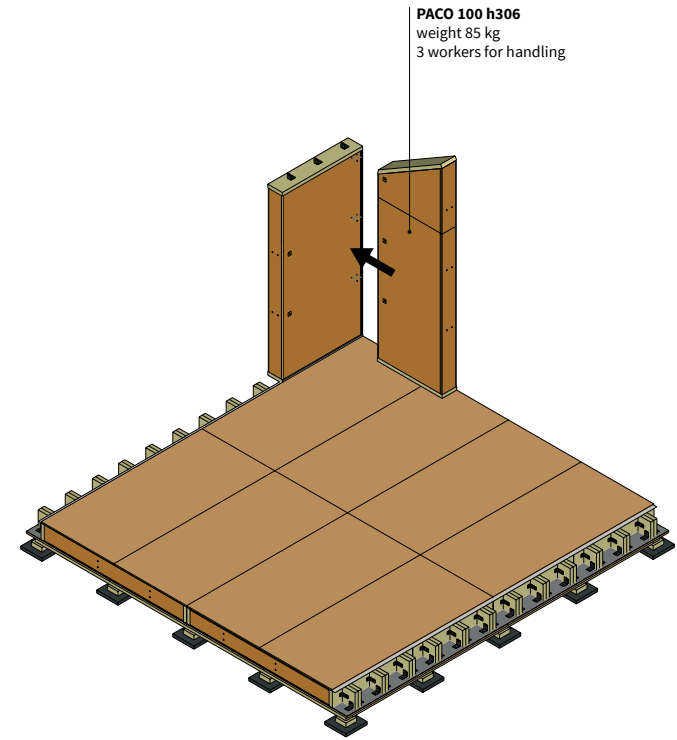
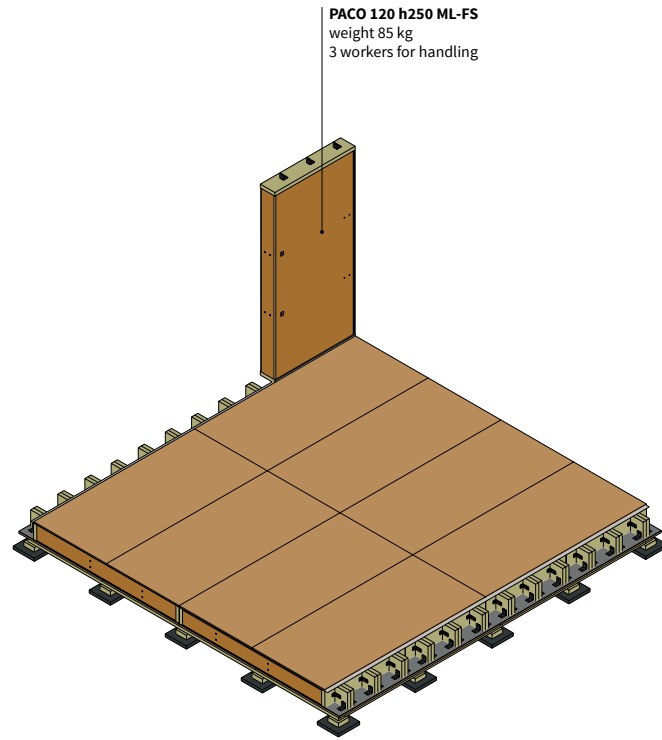

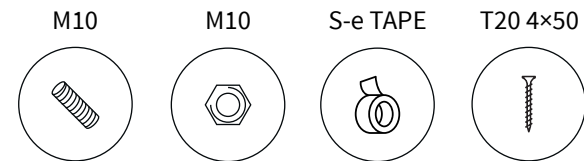
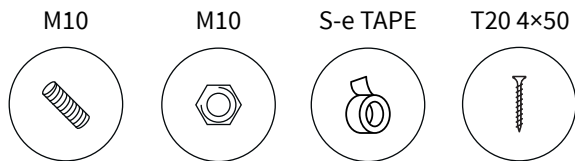
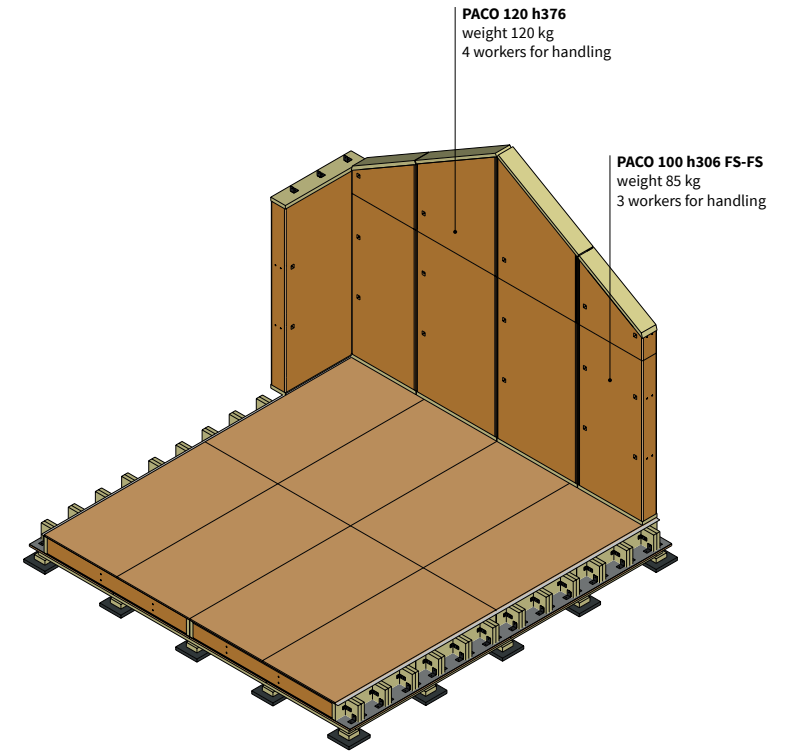
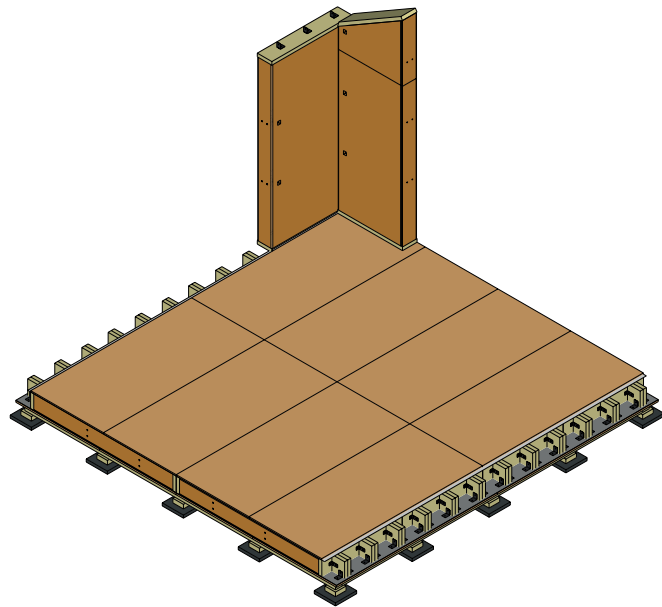
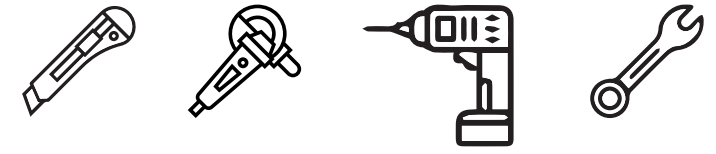
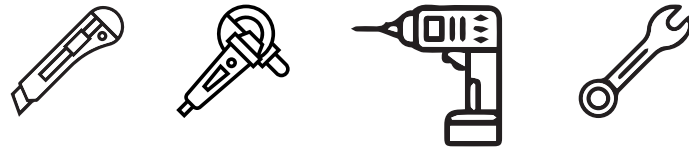



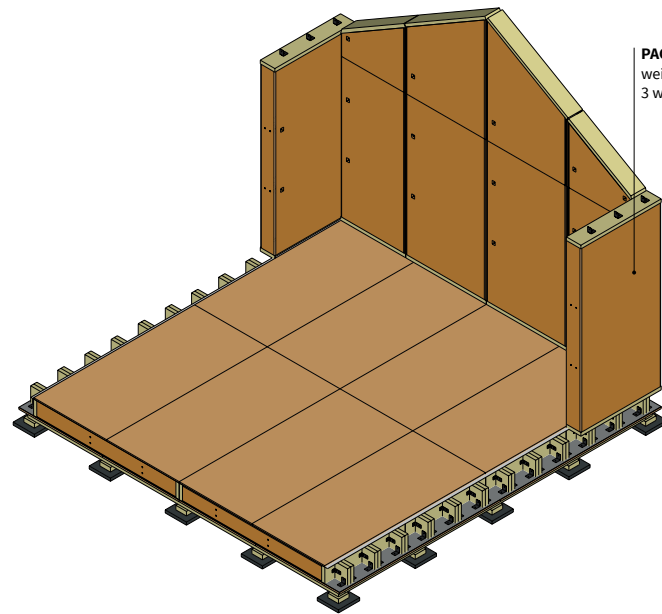
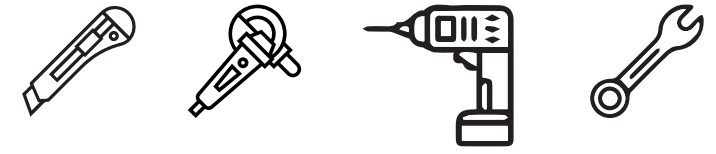
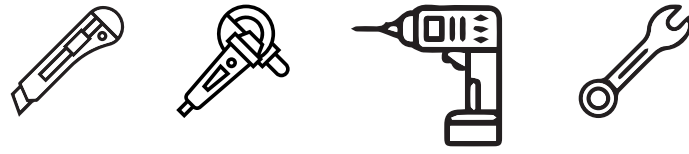

**PACO 120 h250 MS-ML**  
weight 85 kg  
3 workers for handling

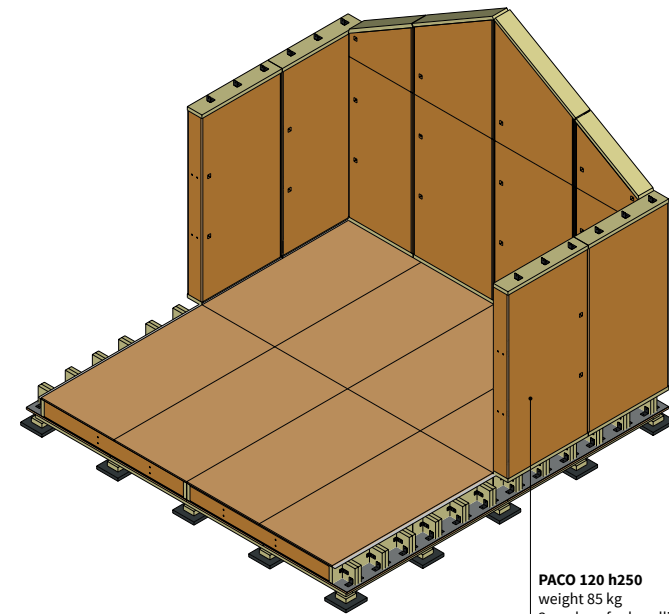

**PACO 120 h250**  
weight 85 kg  
3 workers for handling

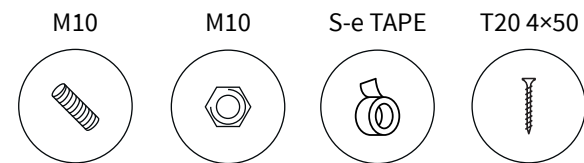
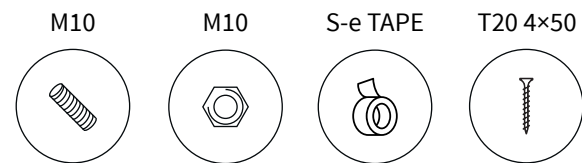

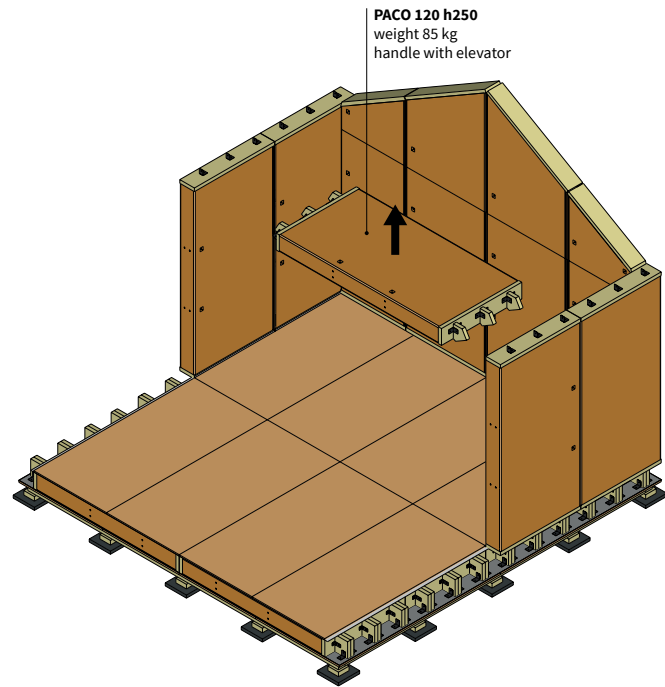

PACO 120 h250  
weight 85 kg  
handle with elevator

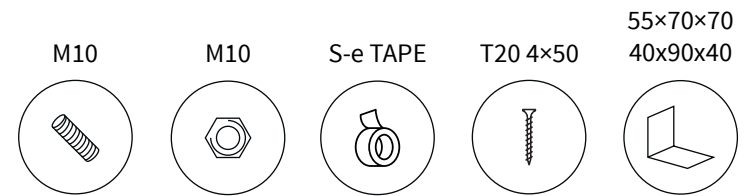
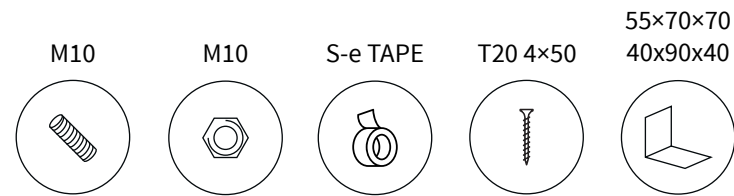
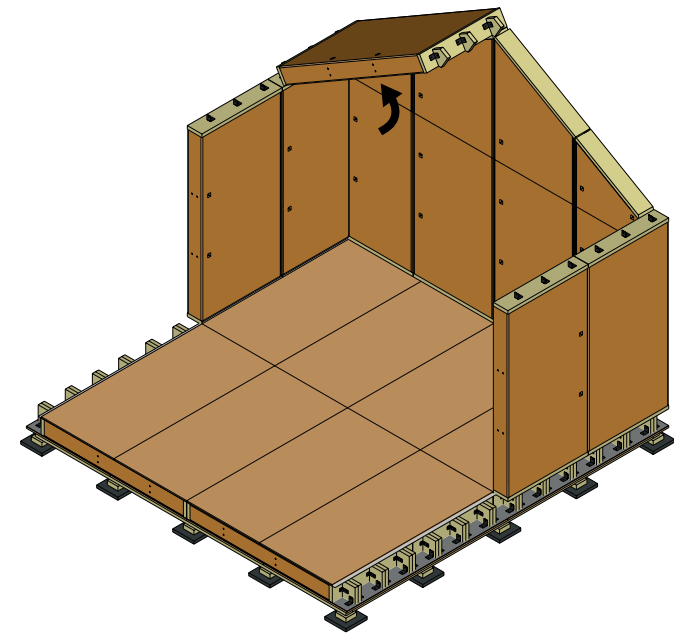

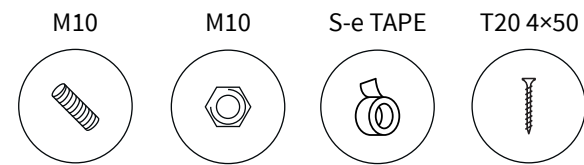
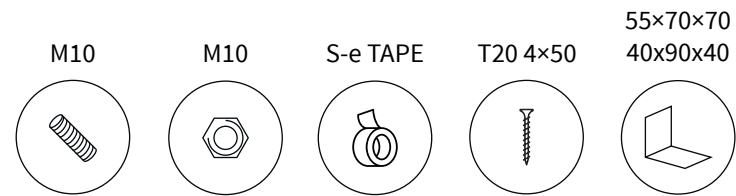
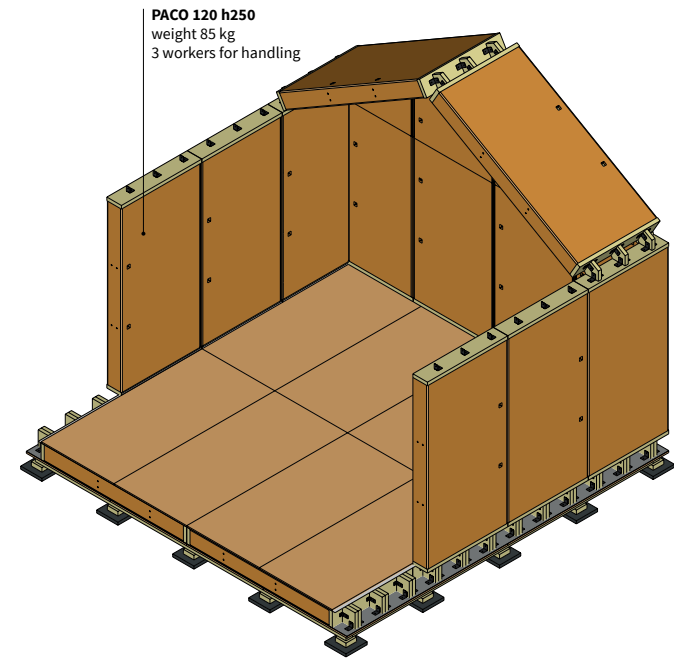
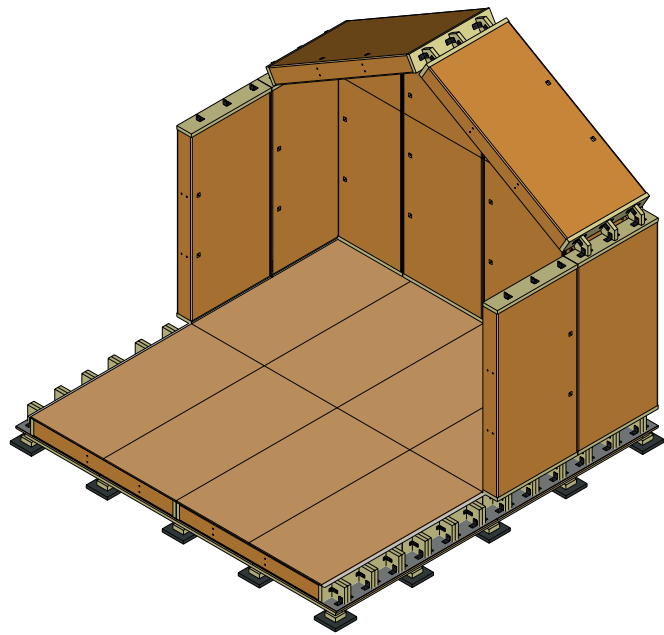
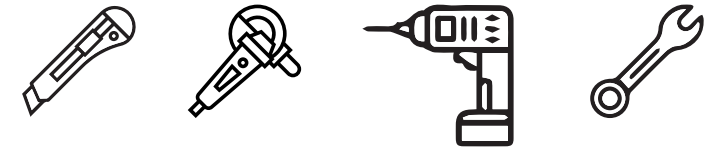

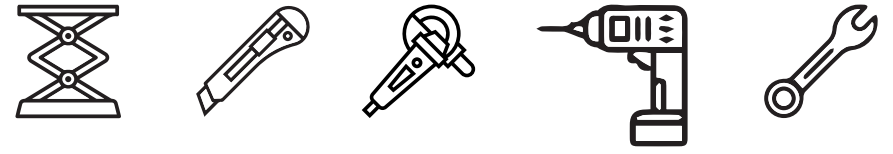

PACO 120 h250  
weight 85 kg  
handle with lifter

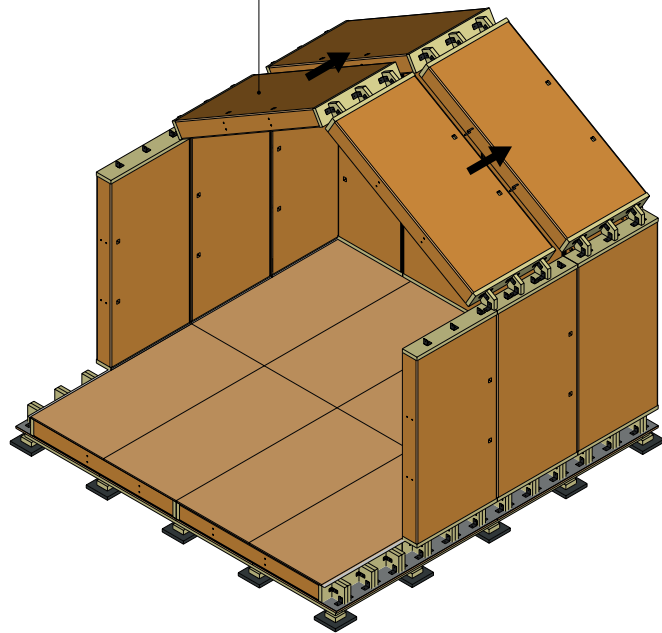

PACO 120 h250  
weight 85 kg  
handle with lifter

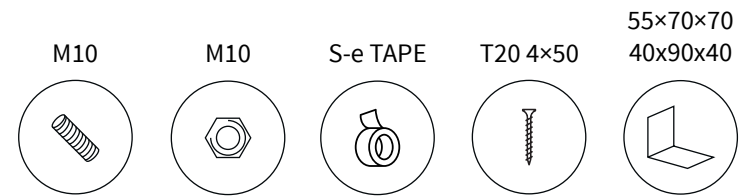
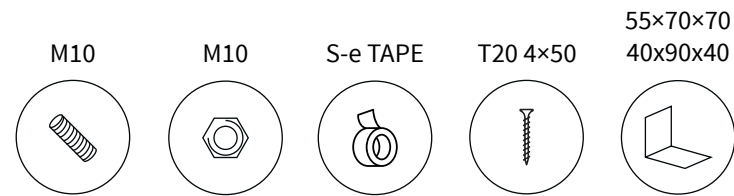
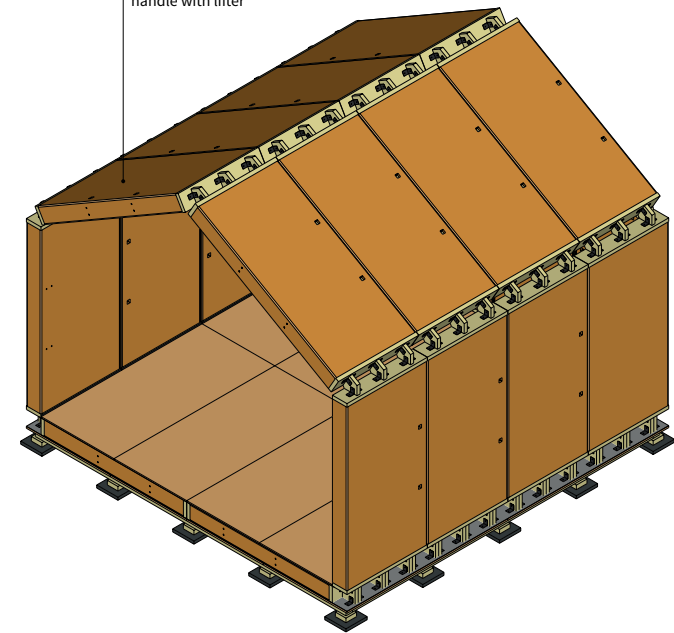

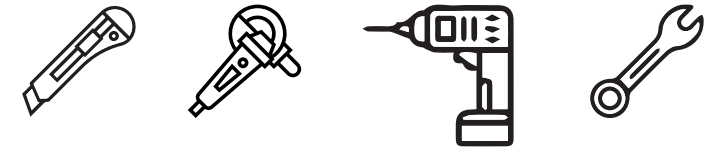
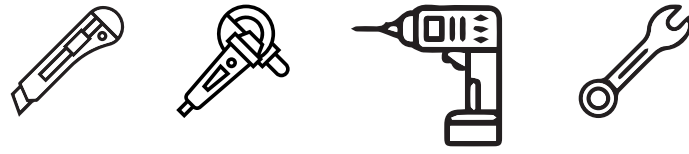

**PACO 120 h250 MS-ML**  
weight 85 kg  
3 workers for handling

**PACO 100 h306 FS-FS**  
weight 85 kg  
3 workers for handling

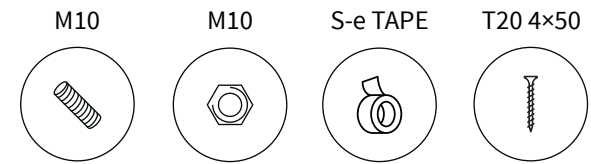
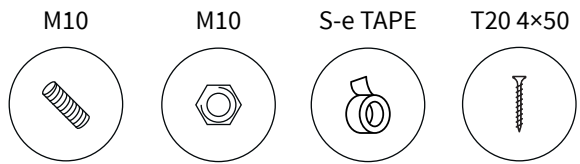
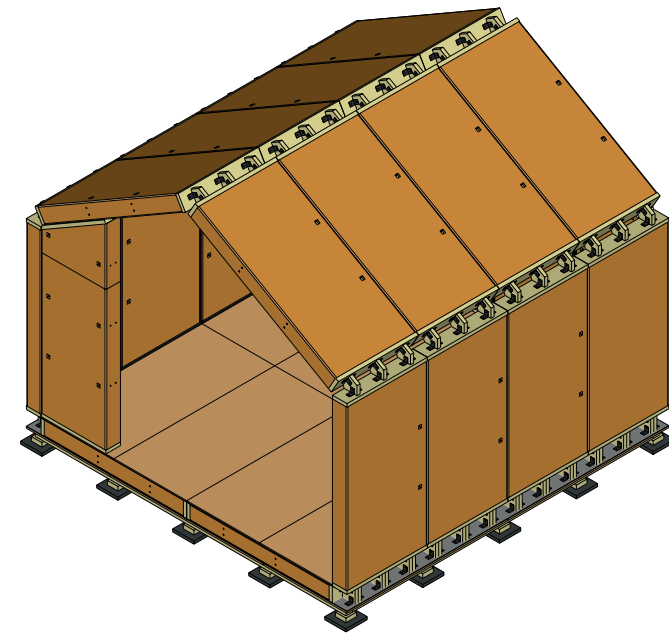
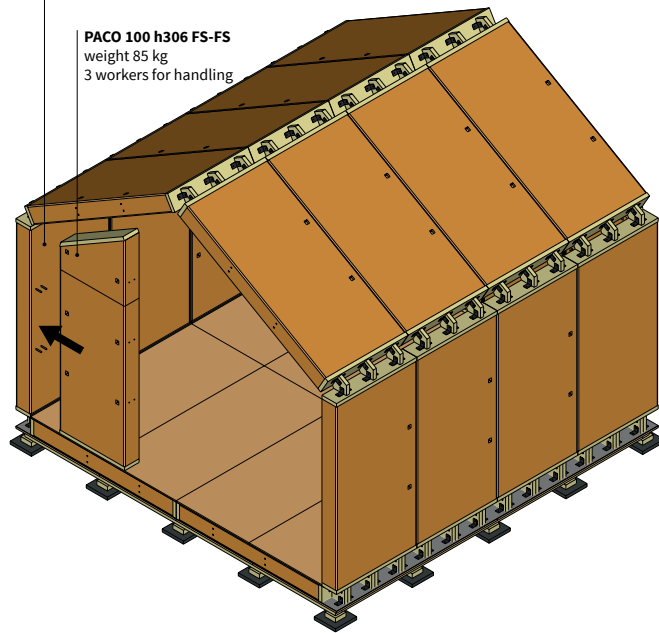

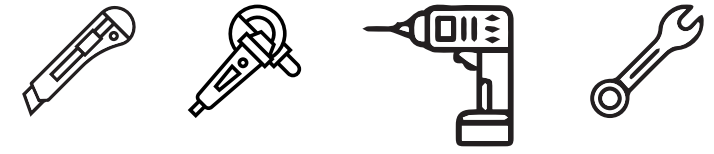
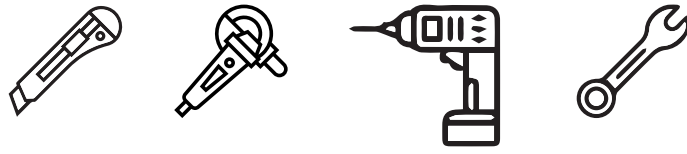

**PACO 100 h306**  
weight 85 kg  
3 workers for handling

**PACO 120 h250 ML-FS**  
weight 85 kg  
3 workers for handling

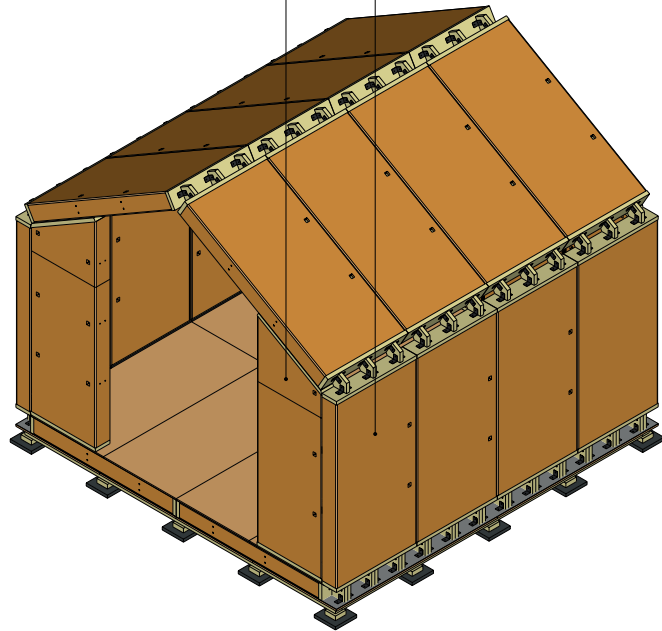

**PACO 120 h376**  
weight 120 kg  
4 workers for handling

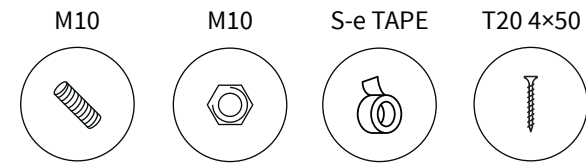
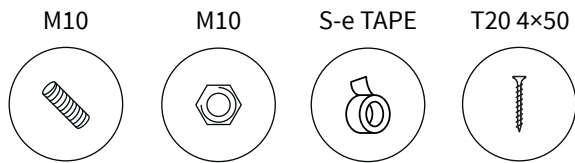
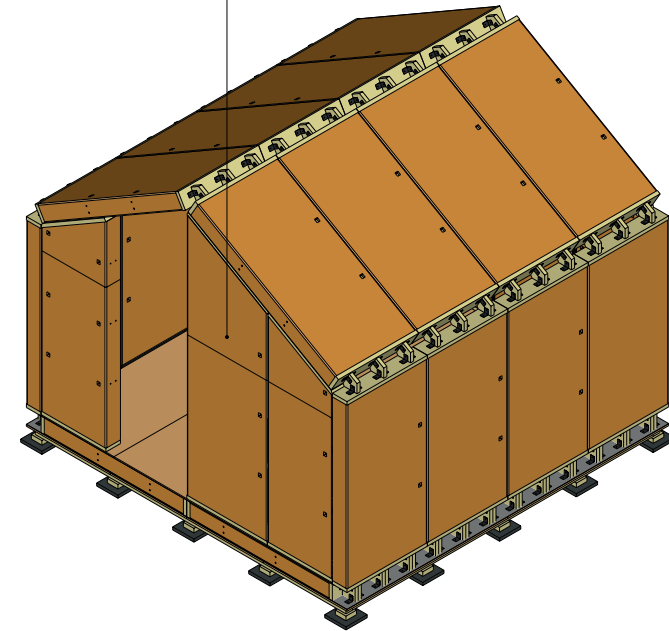

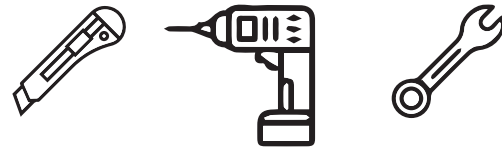

**DOOR 120**  
weight 70 kg + 35 kg  
3 workers for handling

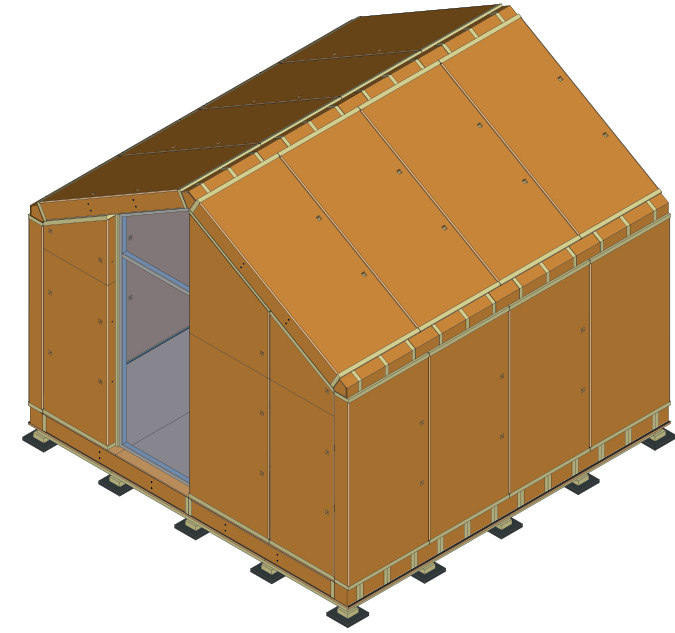
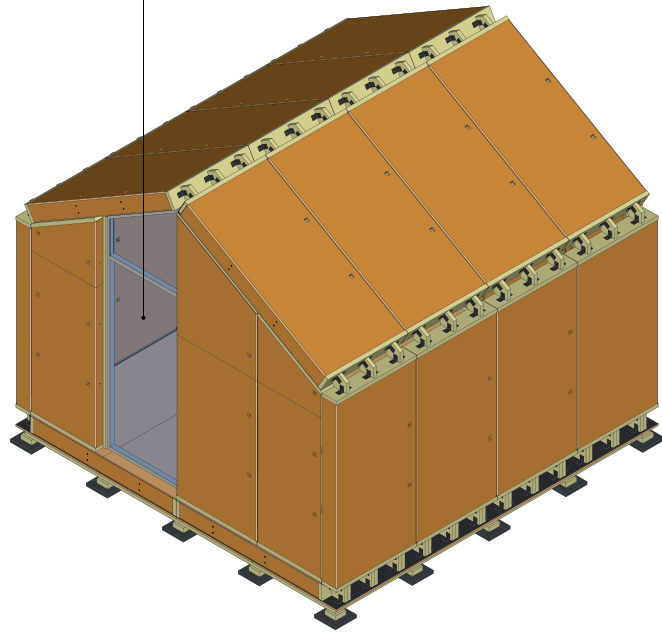

S-e TAPE

T20 5×70

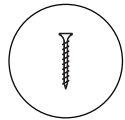
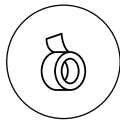

AIR SEALING TAPE

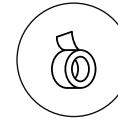

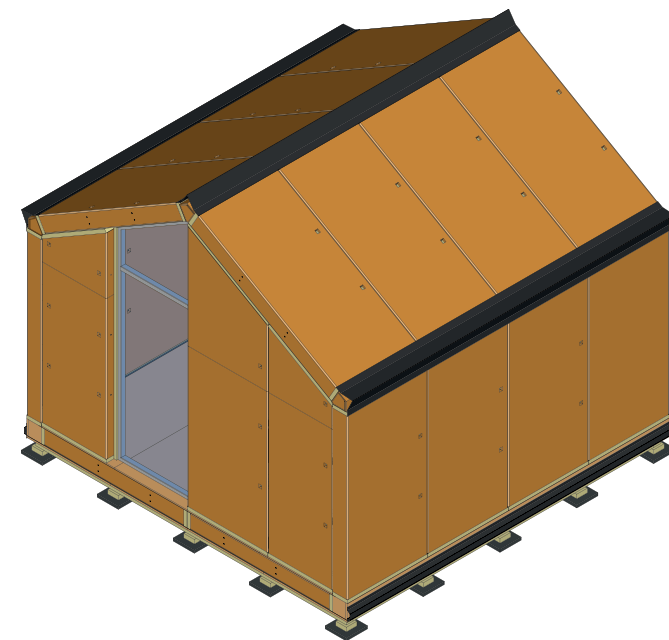
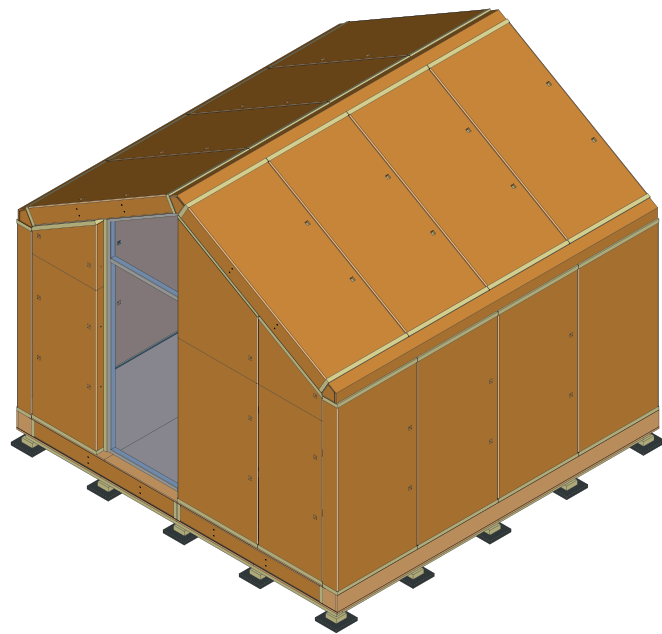
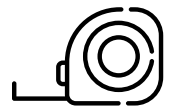
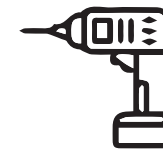

AIR SEALING TAPE



AIR SEALING TAPE

T20 4x40

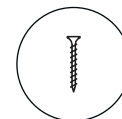
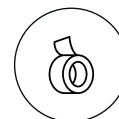



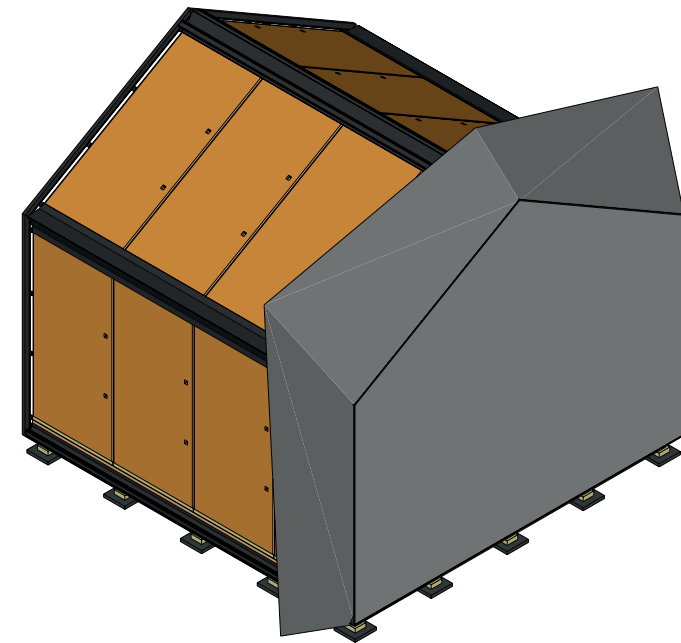
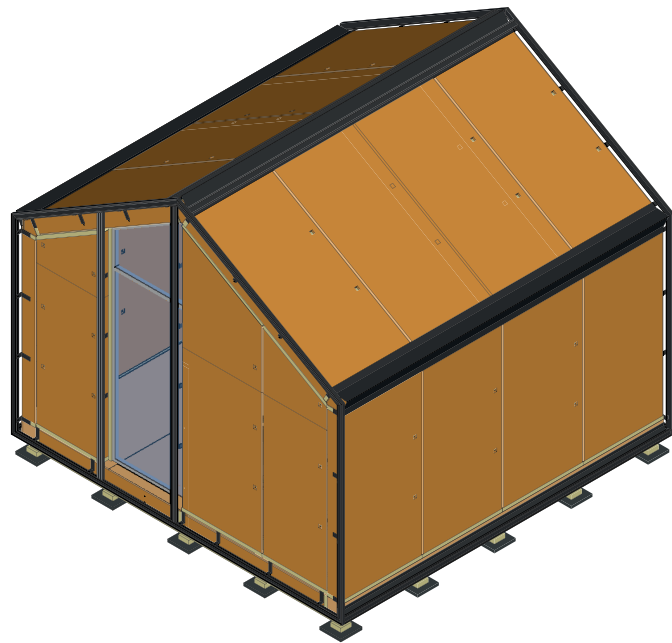
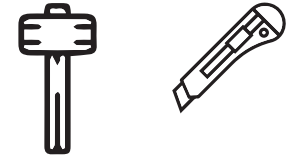

50x135x75 T20 4x40

